



EUROPE, ASIA AND AFRICA
2018





Dear World Traveller,

At AmaWaterways, we love what we do — providing our guests with the best travel experiences possible. In fact, “Ama” is derived from the Latin word for “love.” It is a concept that permeates every aspect of our river cruises, from the design of our ships and the development of our itineraries to the high levels of service we deliver to our guests. We always look to innovate, offer exciting new destinations and add extra value for each and every guest who travels with us.

Since 2002, we have expanded our global fleet to 20 ships, and we will continue to add more one-of-a-kind ships with the AmaLea in 2018 which will include staterooms with connecting rooms to accommodate more than two guests, as well as our revolutionary signature twin balconies. We'll also introduce six new expertly crafted itineraries in Europe, as well as new itineraries in Asia and Africa. And we continue to enrich our always included shore excursions with more choices for our guests to personalise their experience with even more active options.

AmaWaterways was the first river cruise line to offer complimentary bicycles for guests to use, and today, we recognise our guests wish to continue their health and wellness lifestyle when they travel. Therefore, we have curated an even more comprehensive selection of exclusive guided biking and hiking tours for those wishing to be more active. And in keeping with our growing approach to wellness travel, year after year our menus offer more delicious and healthy choices.

We are always whole-heartedly dedicated to the happiness of our guests. Whichever destination you choose, you're sure to fall in love with our river cruises. On behalf of the entire AmaWaterways family, we look forward to welcoming you on board soon.

Sincerely,

Rudi Schreiner
President

Kristin Karst
Executive Vice President

Gary Murphy
Vice President, Sales

AMAWATERWAYS, FAMILY OWNED AND OPERATED SINCE 2002



Representing our family ownership, from left to right: Rudi Schreiner, President; Kristin Karst, Executive Vice President; Gary Murphy, Vice President of Sales

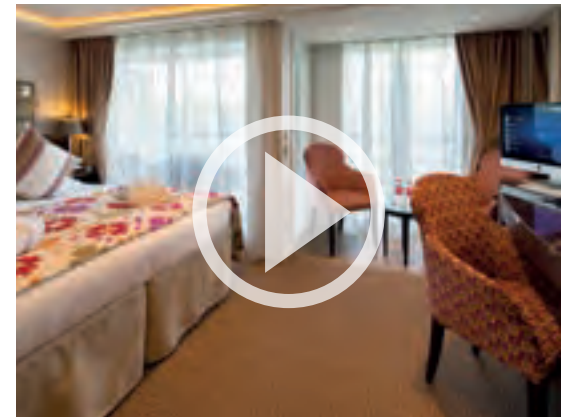

BRING THIS BROCHURE TO LIFE

Watch our video, *Cruise in Luxury*, by going to amawaterways.co.uk/luxury

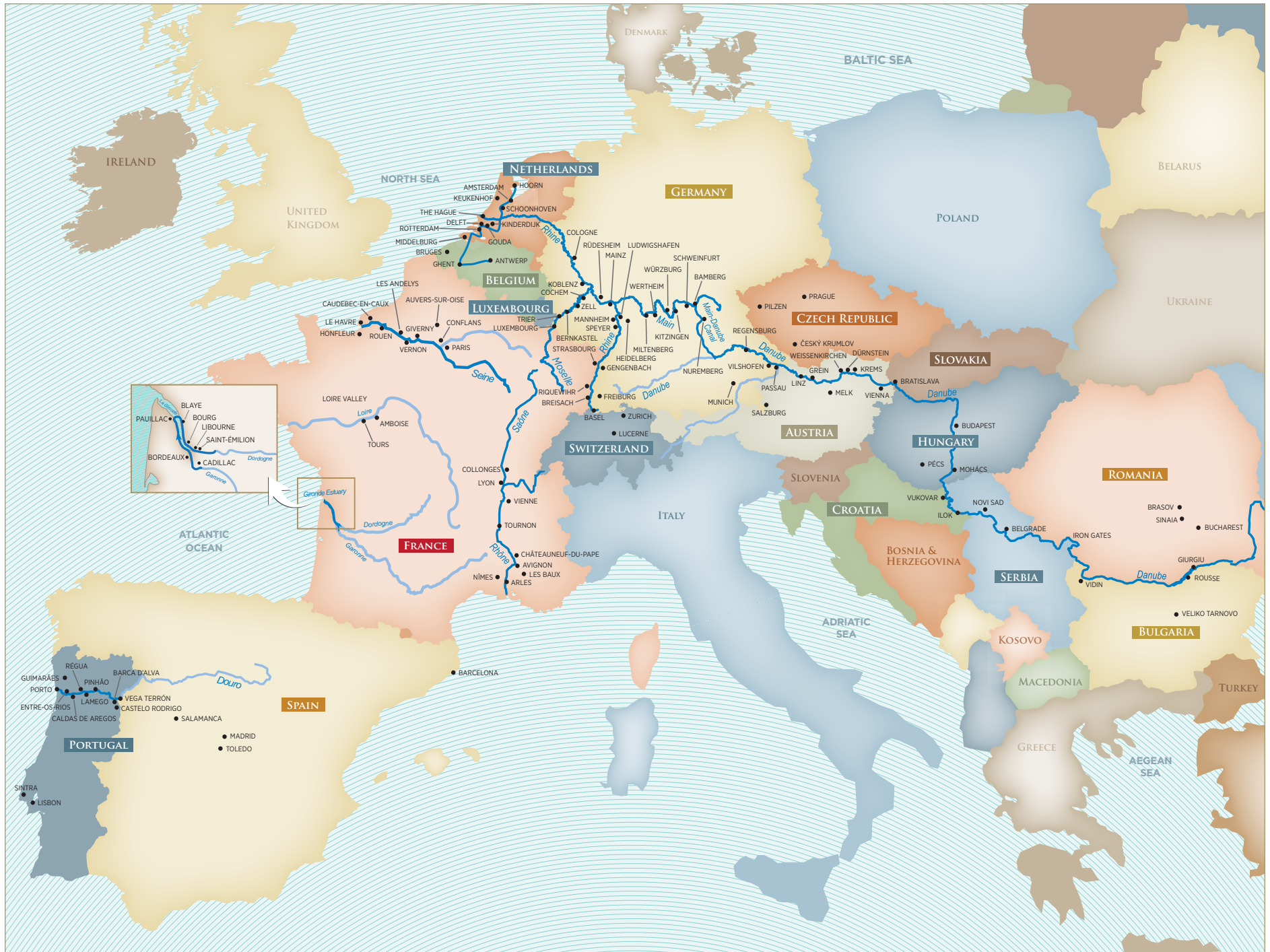

TABLE OF CONTENTS

EUROPE AT-A-GLANCE	4	BLUE DANUBE DISCOVERY	80	CHARMS OF THE MEKONG NEW FOR 2018	148
OUR STORY	6	7-NIGHT CRUISE		2 NIGHTS IN HO CHI MINH CITY, 7-NIGHT MEKONG CRUISE, 2 NIGHTS IN SIEM REAP, 3 NIGHTS IN HANOI & 1 NIGHT IN HA LONG BAY	
AND THE AWARDS GO TO	8	DANUBE SERENADE NEW FOR 2018	84	AFRICA SAFARIS & WILDLIFE CRUISE	152
YOUR CRUISE, YOUR WAY	10	7-NIGHT CRUISE		DISCOVER AFRICA	154
MORE ROOM, BETTER VIEWS	12	GEMS OF SOUTHEAST EUROPE	88	3 NIGHTS IN CAPE TOWN, 4-NIGHT SAFARI CRUISE & 2 NIGHTS IN VICTORIA FALLS	
BE OUR GUEST	14	7-NIGHT CRUISE		RIVERS & RAILS OF AFRICA	156
GOLD MEDAL DINING	16	EUROPE'S RIVERS & CASTLES	92	3 NIGHTS IN CAPE TOWN, 4-NIGHT SAFARI CRUISE, 2 NIGHTS IN VICTORIA FALLS & 3-NIGHT ROVOS RAIL TRAIN	
EXPLORE THE WORLD YOUR WAY	18	7-NIGHT CRUISE		WILDLIFE & THE FALLS NEW FOR 2018	158
READY. SET. GET ACTIVE	20	MEDIEVAL TREASURES NEW FOR 2018	96	1 NIGHT IN JOHANNESBURG, 4-NIGHT SAFARI CRUISE, 2 NIGHTS IN VICTORIA FALLS, 2 NIGHTS IN JOHANNESBURG & 3 NIGHTS GREATER KRUGER NATIONAL PARK	
HIKING & BIKING TOURS	22	7-NIGHT CRUISE		STARS OF SOUTH AFRICA	160
CONCIERGE GOLF PROGRAMME	28	CAPTIVATING RHINE	100	3 NIGHTS IN CAPE TOWN, 4-NIGHT SAFARI CRUISE, 2 NIGHTS IN VICTORIA FALLS & 3 NIGHTS GREATER KRUGER NATIONAL PARK	
UNIQUE WINE EXPERIENCES	34	7-NIGHT CRUISE		GOLDEN TRAILS OF EAST AFRICA	162
WINE CRUISE ITINERARIES	38	ENCHANTING RHINE	104	1 NIGHT IN JOHANNESBURG, 4-NIGHT SAFARI CRUISE, 2 NIGHTS IN VICTORIA FALLS, 2 NIGHTS IN JOHANNESBURG & 3 NIGHTS GREATER KRUGER NATIONAL PARK	
CHRISTMAS CRUISES	40	2 NIGHTS IN ZURICH		AMALEA, AMAKRISTINA, AMAVIOLA & AMASTEELLA	164
EXTEND YOUR STAY	42	RHINE & MOSELLE SPLENDOURS NEW FOR 2018	108	AMASERENA, AMAVENITA, AMASONATA AMAREINA, AMAPRIMA & AMACERTO	166
FRANCE AND PORTUGAL	44	7-NIGHT CRUISE		AMALYRA, AMADOLCE, AMADANTE & AMACELLO	168
TASTE OF BORDEAUX	46	RHINE & MOSELLE DELIGHTS NEW FOR 2018	112	AMAVIDA	170
7-NIGHT CRUISE		10-NIGHT CRUISE		AMADARA	172
PARIS & NORMANDY	50	RHINE & MOSELLE FAIRYTALES NEW FOR 2018	116	ZAMBEZI QUEEN	174
7-NIGHT CRUISE		11-NIGHT CRUISE		TERMS & CONDITIONS	176
COLOURS OF PROVENCE	54	MAGNIFICENT EUROPE	120		
7-NIGHT CRUISE		14-NIGHT CRUISE FROM AMSTERDAM TO BUDAPEST			
ENTICING DOURO	58	GRAND DANUBE CRUISE	124		
7-NIGHT CRUISE		14-NIGHT CRUISE			
THE HEART OF EUROPE	62	ICONIC CHRISTMAS MARKETS	128		
TULIP TIME	64	7-NIGHT CRUISE			
7-NIGHT CRUISE IN THE NETHERLANDS & BELGIUM		MAGICAL CHRISTMAS MARKETS NEW FOR 2018	132		
ROMANTIC DANUBE	68	7-NIGHT CRUISE			
7-NIGHT CRUISE		CHRISTMAS MARKETS ON THE RHINE	136		
MELODIES OF THE DANUBE	72	7-NIGHT CRUISE			
7-NIGHT CRUISE		EXOTICS AT-A-GLANCE	140		
LEGENDARY DANUBE	76	OUR EXOTIC SHIPS	142		
7-NIGHT CRUISE		AUTHENTIC EXPERIENCES	143		
		RICHES OF THE MEKONG	144		
		2 NIGHTS IN HANOI, 1 NIGHT IN HA LONG BAY, 3 NIGHTS IN SIEM REAP, 7-NIGHT MEKONG CRUISE & 2 NIGHTS IN HO CHI MINH CITY			

EUROPE AT-A-GLANCE

ITINERARY / CRUISE START & END CITIES	PAGE	NO. OF NIGHTS	SHIPS	RIVERS	COUNTRIES VISITED	LAND PROGRAMMES	CRUISE EMBARKATION - DISEMBARKATION																
							JAN	FEB	MAR	APR	MAY	JUN	JUL	AUG	SEP	OCT	NOV	DEC					
TASTE OF BORDEAUX BORDEAUX TO BORDEAUX	46	7	AmaDolce	Garonne Dordogne Gironde Estuary	France	Paris Loire Valley																	
PARIS & NORMANDY PARIS TO PARIS	50	7	AmaLyra	Seine	France	Paris																	
COLOURS OF PROVENCE LYON TO ARLES OR REVERSE	54	7	AmaCello	Rhone	France	Paris Barcelona																	
ENTICING DOURO PORTO TO PORTO	58	7	AmaVida	Douro	Portugal	Lisbon																	
TULIP TIME AMSTERDAM TO AMSTERDAM	64	7	AmaLea AmaKristina AmaPrima	Dutch & Belgian Waterways	The Netherlands Belgium	Amsterdam																	
ROMANTIC DANUBE VILSHOFEN TO BUDAPEST	68	7	AmaCerto AmaLea	Danube	Austria Germany Hungary Slovakia	Prague Munich																	
MELODIES OF THE DANUBE BUDAPEST TO VILSHOFEN	72		AmaSerena AmaViola																				
LEGENDARY DANUBE NUREMBERG TO BUDAPEST	76	7	AmaCerto AmaSonata	Danube	Austria Germany Hungary	Prague																	
BLUE DANUBE DISCOVERY BUDAPEST TO NUREMBERG	80	7	AmaCerto AmaLea AmaSerena AmaSonata AmaViola	Danube	Austria Germany Hungary	Budapest Prague																	
DANUBE SERENADE <i>NEW</i> NUREMBERG TO VIENNA OR REVERSE	84	7	AmaCerto AmaSerena AmaSonata	Danube	Czech Rep Germany Austria	Prague Vienna																	
GEMS OF SOUTHEAST EUROPE BUDAPEST TO GIURGIU OR REVERSE	88	7	AmaCerto	Danube	Hungary Croatia Serbia Bulgaria Romania	Vienna or Budapest Bucharest Braşov																	
EUROPE'S RIVERS & CASTLES NUREMBERG TO LUXEMBOURG	92	7	AmaDante	Main Rhine Moselle	Germany Luxembourg	Prague Paris																	

ITINERARY / CRUISE START & END CITIES	PAGE	NO. OF NIGHTS	SHIPS	RIVERS	COUNTRIES VISITED	LAND PROGRAMMES	CRUISE EMBARKATION - DISEMBARKATION												
							JAN	FEB	MAR	APR	MAY	JUN	JUL	AUG	SEP	OCT	NOV	DEC	
MEDIEVAL TREASURES NEW BASEL TO NUREMBERG	96	7	AmaDante	Rhine Main	Switzerland France Germany	Zurich Prague													
CAPTIVATING RHINE/ ENCHANTING RHINE AMSTERDAM TO BASEL OR REVERSE	100 104	7	AmaKristina AmaPrima AmaSonata AmaStella	Dutch Waterways Rhine	The Netherlands Germany France Switzerland	Lucerne Zurich													
RHINE & MOSELLE SPLENDOURS NEW LUXEMBOURG TO BASEL	108	7	AmaDante	Moselle Rhine	Luxembourg Germany France Switzerland	Paris Zurich													
RHINE & MOSELLE DELIGHTS NEW BASEL TO AMSTERDAM	112	10	AmaPrima	Rhine Moselle Dutch Waterways	Switzerland France Germany The Netherlands	Zurich													
RHINE & MOSELLE FAIRYTALES NEW AMSTERDAM TO BASEL	116	11	AmaPrima	Dutch Waterways Rhine Moselle	The Netherlands Germany France Switzerland	Zurich													
MAGNIFICENT EUROPE AMSTERDAM TO BUDAPEST OR REVERSE	120	14	AmaLea AmaPrima AmaSerena AmaSonata	Dutch Waterways Rhine Main Danube	The Netherlands Germany Austria Slovakia Hungary	Not Available													
GRAND DANUBE CRUISE NUREMBERG TO GIURGIU OR REVERSE	124	14	AmaCerto	Danube	Germany Austria Croatia Hungary Serbia Romania Bulgaria	Prague Bucharest													
ICONIC CHRISTMAS MARKETS BUDAPEST TO NUREMBERG OR REVERSE	128	7	AmaLea AmaSerena AmaViola	Danube	Hungary Austria Germany	Prague													
MAGICAL CHRISTMAS MARKETS NEW NUREMBERG TO VIENNA OR REVERSE	132	7	AmaCerto AmaSerena AmaSonata	Danube	Germany Austria	Prague Vienna													
CHRISTMAS MARKETS ON THE RHINE AMSTERDAM TO BASEL OR REVERSE	136	7	AmaKristina AmaPrima AmaSerena AmaStella	Dutch Waterways Rhine	The Netherlands Germany France Switzerland	Lucerne Zurich													



OUR STORY

Family-owned and operated, AmaWaterways has been a passion project for its founders since its creation in 2002. President Rudi Schreiner designed his first ship back in 1975 while sailing the Amazon for seven months. Since the completion of the Rhine-Main-Danube Canal in 1992, Rudi has been a driving force for river cruise travel—and for these efforts has been recognised as the “Most Innovative Cruise Executive” and has been presented the prestigious “Lifetime Achievement Award” by Cruise Lines International Association (CLIA).

Executive Vice President, Co-Founder and Co-Owner Kristin Karst brings extensive experience in luxury travel, river cruising and customer service to AmaWaterways. Rudi and Kristin partnered with Jimmy Murphy, a brilliant travel entrepreneur who built Brendan Vacations. His son Gary now carries on his father’s tradition in his role as Vice President of Sales. These families came together to create the premier travel experience for AmaWaterways’ guests.

Our commitment to this unifying goal is what makes an AmaWaterways river cruise stand out from the rest. While we received the 2016 Cruise Critic Editors’ Picks Award for the “Best River Cruise Line” and were recognised as having the “Highest Rated River Cruise Ships in Europe” by travel authority Berlitz, we never rest on our laurels. AmaWaterways is always humbled by the wonderful accolades we receive, which underscore our whole-hearted dedication to the happiness of each and every guest who travels with us.

In late 2016, we were delighted to add a new chapter to our story with the opening of our first office in the United Kingdom. Led by Managing Director, Stuart Perl and based in Guildford, Surrey, this new part of the AmaWaterways family strives to match the high standards of service set by Rudi, Kristin and Jimmy while we work to bring our award-winning product to more people across the United Kingdom.



Our worldwide staff has grown significantly since we first started in 2002.



BRING THIS BROCHURE TO LIFE

Watch our video, *Life on Board*, by going to amawaterways.co.uk/onboard



AND THE AWARDS GO TO...

Our fabulous guests and the passion of our hard-working staff makes AmaWaterways the world's premier river cruise line. For the past fifteen years, AmaWaterways has had the honour and privilege of providing travellers around the world with cherished memories on board award-winning ships, inspired by luxury yachts and designed specifically to maximise every aspect of our guests' experience.

At AmaWaterways, we only hire the best of the best. Each member of our crew—whether it's a stateroom steward or a Cruise Manager—is an expertly-trained professional with a passion for what they do and a commitment to excellence. We go above and beyond to ensure all our guests enjoy the most exceptional experience.

This may mean planning something extra special for an anniversary or birthday, remembering how you like your favourite drink or preparing your morning omelette with just the right blend of ingredients. Be assured that you are travelling on the most innovative ships, offering the best in dining, service and accommodations. AmaWaterways is not only recognised by travel authority Berlitz for having the highest rated river cruise ships in Europe, but has also received countless other accolades, including the 2016 Cruise Critics Editors' Picks Award for the "Best River Cruise Line."



Best Overall River Cruise Line

- ◆ Best for Onboard Activities
- ◆ Best for On-Shore Activities
- ◆ Best for Food



UNPRECEDENTED TOP 10

Known for its international travel and language expertise, *Berlitz* has published cruise guides for 30 years. Author Douglas Ward, a leading authority on cruising, has over 40 years of experience and has spent more than 6,000 days on board covering more than 1,000 voyages. AmaWaterways received the "Top 10 Rated River Cruise Ships" out of 310 ships reviewed based on accommodations, dining, service and other onboard features.

RANK	SHIP	RIVER CRUISE LINE	OVERALL SCORE
1	AmaPrima	AmaWaterways	423 points
2	AmaReina	AmaWaterways	423 points
3	AmaSerena	AmaWaterways	423 points
4	AmaSonata	AmaWaterways	422 points
5	AmaVida	AmaWaterways	421 points
6	AmaVerde	AmaWaterways	420 points
7	AmaVenita	AmaWaterways	419 points
8	AmaCerto	AmaWaterways	414 points
9	AmaBella	AmaWaterways	413 points
10	AmaLyra	AmaWaterways	413 points



Note: A number of new sister ships of the AmaPrima have joined our fleet since the Berlitz guide was published: AmaStella, AmaViola, AmaKristina and AmaLea.



YOUR CRUISE, YOUR WAY

Any cruise line can take you from here to there; AmaWaterways takes you even further.

- ◆ Deluxe cruise accommodations in finely appointed riverview staterooms and suites—most with signature twin balconies or French balconies
- ◆ Stateroom and suite appointments include white-on-white plush bedding, terry bathrobes and slippers, high-quality bath and body products and bottled water replenished daily
- ◆ Suites include added enhancements, such as larger sitting areas and expansive bathrooms with both a shower and bathtub
- ◆ Entertainment-On-Demand centre in all staterooms and suites with complimentary high-speed internet access, hit Hollywood movies, extensive music library and English language TV stations
- ◆ La Chaîne des Rôtisseurs dining experience—featuring all meals on board, including exquisite multi-course dinners and bountiful breakfast and lunch buffets
- ◆ Multiple dining venues, including the one-of-a-kind Chef's Table specialty restaurant featuring our unique tasting menu with perfectly paired wines
- ◆ Hand-selected unlimited complimentary red and white wines from Europe's great wine regions, beer and soft drinks served with every lunch and dinner on board
- ◆ Sip & Sail daily cocktail hour with complimentary wine, beer and spirits
- ◆ Welcome Cocktail Reception, Welcome Dinner, La Chaîne des Rôtisseurs Dinner, Captain's Cocktail Reception and Gala Dinner
- ◆ Complimentary Wi-Fi on board
- ◆ Expertly guided shore excursions with choices to tailor your experience as you like
- ◆ Exclusive Special Interest Tours
- ◆ Adventurous guided bicycle and hiking tours (Nordic walking sticks available)
- ◆ Complimentary bicycles and helmets to explore on your own
- ◆ Extra special programmes, including lectures, theme dinners, cooking demonstrations, onboard music performances and afternoon/evening piano music
- ◆ Professionally trained, all English-speaking staff
- ◆ Experienced and dedicated Cruise Manager who accompanies you throughout your entire journey, both on land and on your cruise

Note: Amenities may vary by region and ship.



SIGNATURE TWIN BALCONIES

Enjoy stunning panoramic views and plenty of fresh air from the privacy of our lavish twin balcony staterooms that feature both a French balcony and an outside balcony.



AWARD-WINNING DINING

Savour delicious cuisine at a variety of dining venues, including The Chef's Table specialty restaurant, where our chefs prepare an exquisite tasting menu.



ENTERTAINMENT

Whether it's traditional Bavarian music or a local quartet, there is an eclectic schedule of nightly onboard entertainment.



MASSAGE & HAIR SERVICES

Pamper yourself with a soothing massage or get your hair styled for a memorable night at our onboard hair salon.



SUN DECK POOL & SWIM-UP BAR

Soak up the sun in our sun deck pool complete with swim-up bar and enjoy a chance to relax and watch the world drift past.



WELLNESS TRAVEL

Our approach to wellness includes walking tours, morning jogs, guided bike and hiking tours, a fitness room and a selection of healthy food choices.



MORE ROOM, BETTER VIEWS

When you find yourself sitting on your private balcony in a soft robe and slippers watching the sun rise over a fairytale castle, you know you are in the right place. Welcome to your luxurious riverview stateroom, thoughtfully designed as your ultimate home-away-from-home floating sanctuary.

After a full day of immersive excursions and active adventures, you'll surely want to curl up in your bed, freshly dressed in plush linens with a choice of pillows and a lovely duvet. Pamper yourself with multi-jet showers and soothing bath and body products in your marble-clad bathroom. Relax with your own personal Entertainment-On-Demand system, featuring choices in new movies, television shows, music and news. Stay connected with friends and family back home with complimentary Wi-Fi. And of course, you're on holiday, so twice-daily housekeeping will take over to keep your room looking pristine throughout your trip.

"I should mention that I love AmaWaterways. This was my 4th river cruise, but first on Ama. The entire crew was wonderful - the food is exceptional - the cabins great - the public spaces delightful..." - PATRICIA S





OUR SIGNATURE TWIN BALCONIES

When you board a river cruise, the views are everything. And while you're sure to love the sights on shore, there is infinitely more to cherish while sailing along the river. Be mesmerised by fairytale castles, historic ruins and charming villages, and see it all in the utmost comfort. Because we've maximised your views with not one, but two private balconies (a French balcony and a full outside balcony) to enjoy the views however you like.

OUTSIDE BALCONY

Wake up and savour a morning cup of coffee, along with refreshing breezes and enchanting scenery, all from the comfort and privacy of your own full-sized balcony.

FRENCH BALCONY

You can still let the light and breeze in if you prefer to relax inside. Your floor-to-ceiling French balcony features a sliding door and was designed for just these moments.



YOUR ULTIMATE RETREAT

Elegant in style and generous in space, we have designed your ultimate retreat with your every comfort and convenience in mind.

- ◆ Spacious riverview staterooms and suites ranging from 140 to 350 square feet—most with our signature twin balconies
- ◆ Marble bathrooms with a multi-jet shower, soothing bath and body products, terry bathrobes, slippers and hair dryer
- ◆ Suites feature added enhancements, including larger sitting area with sofa and two chairs, and expansive bathrooms complete with a bathtub and separate shower
- ◆ A place for everything with generous closet and storage space
- ◆ Desk/dressing table and comfortable sitting area
- ◆ Exclusive Entertainment-On-Demand, featuring Hollywood's newest releases and a selection of classic movies, news, sports and satellite TV, as well as a large selection of music channels
- ◆ Bottled water replenished daily
- ◆ Individually controlled air-conditioning
- ◆ In-room safe
- ◆ Mini-fridge on most ships
- ◆ On some twin balcony ships, you'll now find staterooms with connecting doors, as well as triple accommodations, making river cruising more convenient for groups and families



BE OUR GUEST

Travelling aboard a river cruise isn't just about the wonderful places you'll go; it's very much about the people you will meet. From fellow guests who are sure to become lifelong friends, to a genuinely warm and welcoming staff who go above and beyond to ensure your journey with us is as memorable as possible.

From the moment you step aboard your ship and are greeted by our friendly staff with a flute of bubbly and a red rose from the captain, to the moment you are bid farewell, you will be treated as our guest and a member of our special family. Our staff takes the greatest pride in seeing you smile. It might be a waiter who greets you with your morning coffee specially designed with latte art or the witty bartender who knows exactly how you like your martini. Or it could be your Cruise Manager who knows it's your birthday and surprises you with a special cake made by our talented pastry chef or the Captain who invites you to the wheelhouse as he manoeuvres the ship through a lock. These are only a few things that you can expect when you travel with AmaWaterways.

Cruise after cruise, our guests continue to tell us what a wonderful experience they had and some of their most cherished and memorable moments come from the special touches of our wonderful AmaWaterways family. These are the gestures that truly stand out long after you've returned home and give you the feeling of being surrounded by family.





MEET YOUR CRUISE MANAGER

“The service provided by the employees on this ship was something we rarely see in today’s world... From the time we stepped on the ship to the moment we said our last goodbye... we felt more like friends than customers...” CHRIS AND CARMEN G

YOUR FRIENDLY CONFIDANT

AmaWaterways Cruise Managers are truly a cut above. Not only are they friendly and warm-hearted, but they also have extensive experience in providing exceptional levels of personalised service. Each and every Cruise Manager is extremely knowledgeable about the places you visit, making them your ideal destination concierge. Get to ‘meet’ them before you sail with us online at amawaterways.co.uk/explore/cruise-managers

ALWAYS THERE FOR YOU

Your Cruise Manager is there to share “insider advice” and “the secrets” with you every step of the way while on the river or on shore at your hotel. Whether it’s helping you find the perfect place to buy a special gift, arranging for a unique dining experience or providing an informative lecture, they are there for you.



A DAY IN THE LIFE

We proudly introduce you to one of our family members, Yoana Vasileva, pastry chef from Bulgaria

THE SECRET TO PERFECT PASTRIES AND DESSERTS... PLANNING, PREPARATION AND PATIENCE!

Yoana begins her workday preparing the morning’s delicious pastries, pancakes and waffles. As guests depart for excursions, Yoana and her assistant begin busily preparing a variety of delicious desserts for the daily lunch buffet, including making an assortment of handmade ice creams and sorbets, which change daily.

Later, Yoana creates a spectacular array of desserts for dinner, with options including cakes, cookies, tarts, flans and regional delicacies like crème brûlée. Special requests for birthday or anniversary cakes always enhance a memorable celebration. Yoana also meticulously prepares the trio of desserts for The Chef’s Table specialty restaurant each evening.

Favourite part of the job: using unusual ingredients in delicious desserts—like Pinot Noir ice cream, paired with Chocolate Lindt cake, for a wine-themed cruise.

Yoana’s favourite desserts: Chocolate Lindt cake, lemon sorbet and macarons. To make... and eat!





ENJOY GOLD MEDAL DINING

Executive Chef Primus Perchtold, the winner of three gold medals at the European Championship of Culinary Art, along with his talented team of expert chefs, crafts menus with the finest and freshest local ingredients. Selections change daily, featuring locally-inspired gourmet cuisine and traditional favourites.

Bountiful breakfasts include omelettes made-to-order, freshly baked breads and pastries, waffles topped with whipped cream, bacon and sausage, cereals, yoghurt and fruit. Lunch tempts with an array of fresh salads, soups, sandwiches, meat and seafood dishes and desserts. Evenings offer casual elegance with fillets of salmon, beef tenderloin, peppers and aubergine expertly sautéed and grilled. Appetisers and hand-made desserts are artfully presented—and all paired with distinctive wines—while delicious vegetarian and gluten-free options will be equally enticing.

Or dine your own way, with early-riser breakfasts; light lunches in the main lounge and on the sun deck, weather permitting; and a selection of complimentary tapas, refreshments, snacks and sandwiches throughout the day. You can also dine at The Chef's Table and indulge in an exquisite tasting menu prepared right before your eyes.

COMPLIMENTARY BEVERAGES

Savour complimentary, unlimited distinctive wine, beer and soft drinks for lunch and dinner. Start the day off with sparkling wine, fresh-squeezed juices, coffee and tea. You'll also be treated to our Sip & Sail daily cocktail hour.

ALL-DAY TAPAS MENU

Enjoy delicious delights from our Tapas Menu, which change daily. One day it might be a Mediterranean smorgasbord and the next a Bavarian spread. You'll also find a variety of healthy treats and decadent desserts to satisfy your cravings.



SHARE A MEAL WITH NEW FRIENDS



FRESH, LOCALLY-SOURCED INGREDIENTS



EXCEPTIONAL DINING EXPERIENCES

Always leading the way in innovation, AmaWaterways provides guests with one-of-a-kind dining experiences.

THE CHEF'S TABLE

The only venue of its kind on the rivers, The Chef's Table specialty restaurant seats at most 28 guests and offers you a truly unique culinary experience at no additional charge. Join a few of your fellow guests here where the kitchen—usually hidden—becomes part of the entertainment. Watch as your chef prepares a true tasting menu with three appetisers, a champagne sorbet intermezzo, three main courses and three decadent desserts, all paired with carefully hand-selected wines reflective of the places you visit.

LA CHAÎNE DES RÔTISSEURS

AmaWaterways and its President, Rudi Schreiner, were inducted into La Confrérie de la Chaîne des Rôtisseurs, a prestigious international gastronomic society dedicated to fine cuisine. Membership to La Chaîne des Rôtisseurs is by invitation only and is extended to those possessing world-class culinary acumen. All of our ships in Europe are members and our onboard culinary team is united by a desire to share their expert knowledge with you, which is a delectable tribute to our river cruise line being recognised for its renowned and award-winning dining.



THE CHEF'S TABLE SAMPLE TASTING MENU "TASTE OF BORDEAUX"

Chef's Welcome

Goat Cheese, Yellow Tomatoes & Prune Sauce

Appetiser

Scallop, Marinated Seaweed, Caviar & Rillettes Praline
Foie Gras de Canard & Pumpnickel
Beetroot Carpaccio & Quinoa Rouge

Soup

Fennel Cream, Pernod, Sautéed Escargot & Baguette Chip

Sorbet

Raspberry Sorbet

Main Course

Cod Fillet, Saffron Sauce, Brussels Sprouts & Crayfish Ragout
Charolaise Ox Short Ribs & Médoc Red Wine Sauce
Truffle Mousseline, Asparagus & Porcini Ravioli

Dessert

Peach & Lavender Cake & Fondant Au Chocolat
Fresh Fruit Plate
French Cheese Selection & Biscuits

OUR WINE RECOMMENDATIONS

White

Château Marjose Blanc

Country: France **Area:** Bordeaux

Grape: 45% Sauvignon Blanc, 45% Sémillon, 10% Muscadelle

Characteristics: Grapefruit and lemon with a fresh, sweet and lively character

Red

Château Croix Saint Andre Rouge

Country: France **Area:** Bordeaux

Grape: Cabernet Franc, Cabernet Sauvignon, Côt, Malbec, Merlot

Characteristics: Dark ruby colour with a bouquet that gently unveils fruit with aeration



EXPLORE THE WORLD YOUR WAY

Imagine yourself as part of a Monet masterpiece as you step into his lovely gardens at Giverny. How about returning to a land of kings and queens, knights and ladies, and fables and legends in the ancient medieval city of Veliko Tarnovo and its Tsarevets Castle? Or take a page from the daring explorers who set sail from magnificent Lisbon during the "Age of Discovery" and be inspired to uncover new adventures in the very city that inspired it all.

On an AmaWaterways river cruise, you don't just pass through a destination—you experience it with all of your senses. Follow the routes of emperors and other legendary figures on creative and adventurous itineraries along timeless rivers, through inspiring countryside, historic capitals, fairytale towns and even out-of-the-way hotspots that locals favour. Carefully curated excursions showcase the rich diversity of each place you visit and all are hosted by the most experienced and knowledgeable English-speaking local guides and Cruise Managers who have a genuine passion for world history and a real knack for bringing the past to life.

GET UP CLOSE

At AmaWaterways, we always make it a point to place our guests in small groups. By doing this, you can connect more with your guide and your surroundings in a more intimate setting with front-row views. And because the size of the group is limited, you never wait in long queues.

SET YOUR OWN PACE

If you desire a more relaxed pace, you can join a more leisurely paced group, giving you more time to linger in your favourite spots. For those who would like to sleep longer in the morning, join the "Late Starter" group—because after all it is your holiday.





AN ARRAY OF EXCURSIONS AND CHOICES

We realise our guests have different tastes, so we've developed a menu of complimentary shore excursions in every port of call... and often with several options.

PERSONALISED OPTIONS

There's always a city tour designed to showcase the renowned highlights and landmarks in grand capitals and charming villages. Yet, you can uncover hidden treasures as well or explore an area more actively. Have you already been to Nuremberg and Vienna? Then consider joining one of the Special Interest Tours, specifically designed to place you in the midst of local life. For those who wish to be more active, you can hike and bike through timeless landscapes.

EXCLUSIVE SPECIAL INTEREST TOURS

AmaWaterways' exclusive Special Interest Tours are carefully crafted to give small groups the chance to be even more immersed into the local life. Indulge in a Belgian chocolate making demonstration and tasting in Antwerp; savour Sachertorte and Sekt in Vienna; picnic in the vineyards in Portugal's beautiful city of Régua and learn how to cook quintessential French cuisine in Provence. These are just a few of the highlights you can expect.



EXPERIENCE MORE

Château Malmaison, France: A Napoleon Complex

Napoleon's secret staircase. Josephine's vibrant garden. So many treasures to discover when visiting the home of history's storied lovers: Napoleon and Josephine.

Chic and stylish, Josephine was a darling of Parisian social circles who captured the heart of Napoleon Bonaparte with a fiercely romantic, volatile love story. He proposed marriage after a whirlwind courtship and Josephine soon began renovating their home, the Château Malmaison. Along with the Tuileries, it became the headquarters of the French government from 1800-1802.

Affairs, war and Josephine's inability to produce an heir took their toll on the marriage and they divorced, but Napoleon never stopped loving Josephine. When he visited Malmaison after her death, he collected violets from his beloved's garden and wore them in a locket for the rest of his life. His last word as he lay dying? *Josephine.*

Experience their fiery love story for yourself, visiting Château Malmaison on our "Paris & Normandy" itinerary, as well as read other stories related to the destinations we visit at CONNECTIONS on www.amawaterways.co.uk.





READY. SET. GET ACTIVE

AmaWaterways has lots of fun options for you to get more active, if you wish. From our onboard fitness room to our complimentary bicycles for onshore use, you will have everything needed to get your heart rate going. Our flexible routes take you well beyond the typical tourist paths, deep into the rich culture and natural beauty. Join AmaWaterways and get ready to get active.

EXPLORE ON TWO WHEELS

We carry a fleet of complimentary bicycles and helmets on board, so you can experience Europe's enchanting scenery up close. Feel free to take out a bike for a carefree ride on your own or join one of our exclusive guided tours.

- ◆ Bike along the Danube River between Dürnstein and Melk in Austria's illustrious Wachau Valley
- ◆ Ride through the historic town of Bamberg, a UNESCO World Heritage Site, and see its famous breweries and vibrant market gardens
- ◆ See the medieval city of Rouen in France's historic Normandy region, near the Seine River
- ◆ Take a ride through Vienna, where you'll visit nearby Klosterneuburg Abbey and enjoy cake and coffee
- ◆ Cycle through the Bavarian countryside to Walhalla where you will see the Neoclassical white marble temple inspired by the Parthenon in Athens and built to honour the memory of famous Germans

GO FOR A HIKE

The beauty of Europe doesn't just lie in its architecture and landmarks—there are also breathtaking things to be seen when you venture out into nature. Pick up Nordic walking sticks (provided on board) and go on one of our specially designed hikes that take you off the beaten path in some very beautiful destinations. Here are some examples of hiking opportunities.

- ◆ Trek up to the Veste Oberhaus in Passau, Germany for incredible views over Old Passau
- ◆ Make your way up to Dürnstein Fortress, where it is said that Richard the Lionheart was once held captive
- ◆ Hike up the Philosopher's Path to a panoramic view of Heidelberg and the Neckar River



ACTIVATE YOUR ADVENTURES

Cycling through the French and Austrian countryside or hiking up to fortified castles for the stunning views in magnificent cities like Budapest and Prague offers you a chance to experience a destination from a different perspective as well as gives your usual fitness routines an extra boost.

If you love the energy of indoor spin classes, imagine cycling through the legendary beauty of Austria's Wachau Valley or being rewarded with a special theatrical performance after biking through Vidin, one of Bulgaria's most historically important cities. Or for those whose passion is going for neighbourhood runs or brisk walks, find new scenery to explore along Europe's storied rivers.

Fuel up with a variety of delicious and healthy menu options and you'll come back from your trip feeling more refreshed than ever. You can also take advantage of the complimentary fitness room and walking track, as well as the sun deck pool for a refreshing dip while sailing past historic monuments. Or indulge yourself with a rejuvenating massage after a full day of active exploration.





BIKING AND HIKING ALONG THE RHINE & MOSELLE

Ride into your own fairytale adventure as you explore these delightful regions on two wheels or with an invigorating hike. From the complex network of canals criss-crossing the Netherlands and Belgium to the castle-laden Rhine and its famous tributary, the Moselle, with its stunning, steeply terraced vineyards, these regions offer some of the best vistas on Europe's rivers for you to enjoy.

River cruising, cycling and hiking offer you the chance to get really up close to a destination. Bike through the Netherlands' Golden Age and the Flemish Middle Ages in the old city-centres of Amsterdam, Antwerp and Middleburg. Wind your way along the Moselle with stops at castles in historic towns and sample the wine from Germany's largest wine growing region, and along the Rhine with its many fabled castles. Hike high above Heidelberg the way the philosophers once did on the path named after them or climb to Ehrenfels Castle idyllically situated in the vineyards of Rudesheim.





	INCLUDED BICYCLE TOURS
	INCLUDED HIKING TOURS



ANTWERP Cycle through Belgium's capital, where you will see the quirky quarters beyond what a normal tour would include.



COLOGNE Get locked in to Cologne's timeless beauty as you cycle through historic Old Town. Marvel at the iconic Cologne Cathedral, Town Hall and sights along the Rhine.



COCHEM Hike up to Cochem's Reichsburg Castle and admire the most captivating views of the Moselle River Valley, an absolute must for active explorers.



STRASBOURG Pedal past the half-timbered homes in Strasbourg's Petite France, gorgeous Parc de l'Orangerie and then indulge in the local specialties: beer and pretzels.



TRIER Imagine standing in the very spot where Roman gladiators once held epic contests. A hike to Trier's Roman Amphitheatre is nothing short of a journey back in time.



WÜRZBURG Take in the amazing views of Germany's 'Romantic Road,' passing Würzburg's old Main Bridge, beautiful parks and incredible views of the river on this cycling adventure.



BRATISLAVA Trek up to the Bratislava Castle, the city's most iconic landmark. Perched atop a hill that overlooks the Old Town and the Danube River, the castle's unique design makes it visible from every part of the city.



DÜRNSTEIN Nestled in the heart of Austria's Wachau Valley, Dürnstein is one of the most charming and picturesque towns along the Danube. Enjoy a hike to the historic fortress where Richard the Lionheart was once held captive.



VIENNA Ride from regal Vienna, and along the Danube to the magnificent Klosterneuburg Abbey. Over 900 years old, the abbey is home to sacred works of art, including the "Verdun Alter," the best preserved artwork from the Middle Ages.



VIDIN Enjoy scenic views of Vidin park, an Ottoman era library and even a theatrical performance at Baba Castle, the only entirely preserved medieval castle in Bulgaria.



BIKING AND HIKING ALONG THE DANUBE

The romantic Danube: songs have been written about it, composers have dedicated pieces of music to it and it has been the source of countless stories. Along the Danube's bike path, it's easy to see why. Considered one of Europe's most popular and beautiful river paths, you'll find your own inspiration. Cycle along its river banks, soaked in history, and through dreamy villages of Germany and Austria. Pedal through Austria's renowned Wachau Valley with its vineyard terraces and enchanting monasteries, including the 900-year-old Klosterneuburg Abbey. Discover the beauty of the Main River as you ride along its trail to quirky Bamberg, known for its beer, and through the area where the famous Franconian wine is produced. Take in the amazing views in Würzburg with a hike up to Marienberg Fortress. Explore one of Bulgaria's natural wonders, Belogradchik, or climb high above Passau to enjoy the views of the three rivers.

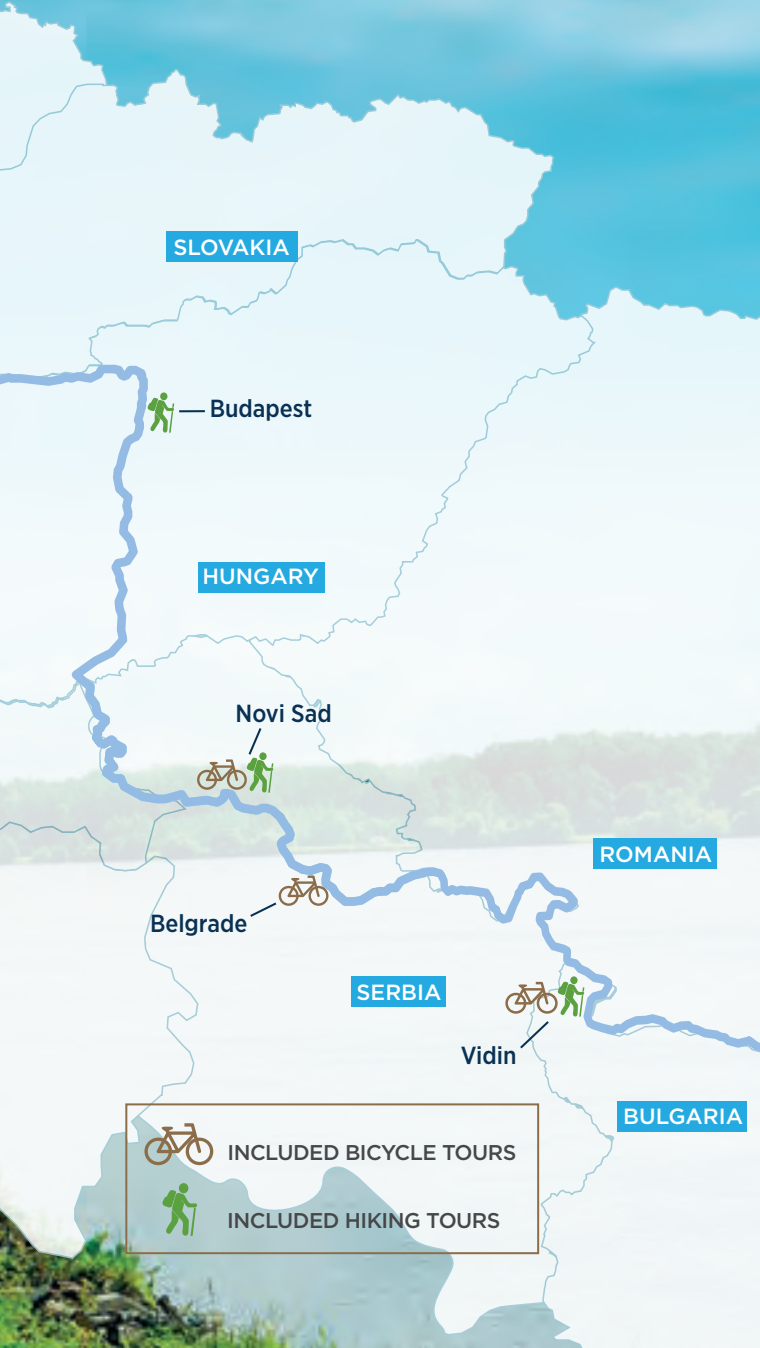

BIKING AND HIKING ALONG THE SEINE, RHÔNE, GARONNE & DORDOGNE

From the dramatic and historic Normandy Coast to the vast vineyards scattered throughout Provence and Bordeaux, France offers cyclists and hikers some of the most varied and breathtaking landscapes. As you cycle through Normandy, the birthplace of impressionism, you'll see the timeless countryside, architectural treasures and charming villages that inspired countless artists and are certain to inspire you. Travel to the south to cycle or hike through Provence, and as you do, think of Van Gogh's sunflowers or Cezanne's immortal landscapes as you become entranced by beautiful and culturally rich towns, such as Arles, Vienne and Avignon. And what better way to discover the vineyards covering the rolling hills of the Bordeaux region, which for centuries have produced some of France's most remarkable wines in Saint-Émilion, Pomerol, Sauternes and Médoc. Châteaux, historic vineyards, fields of flowers, medieval towns and melodious rivers are just waiting for you to discover with biking and hiking tours.





ROUEN Cycle through history-filled streets and landmarks, such as the Notre Dame Cathedral (famously painted by Monet and Lichtenstein) and the square where Joan of Arc was martyred.



LIBOURNE Hike through Libourne's beautiful countryside to a nearby château that offers a stunning panorama of the surrounding vineyards and enjoy a paired wine and tapas tasting.



BORDEAUX Cycle past stately châteaux, Roman amphitheatres and legendary citadels as you wind your way through the stunning vineyard-laced countryside.



TAIN L'HERMITAGE Take a hike through the illustrious vineyards of Tain l'Hermitage, followed by a visit to a local winery where you'll sample some of these world-renowned wines.



ARLES Ride into a slice of art history as you bike through Arles, where Vincent van Gogh painted some of his most famous works, including "Starry Night" and "Irises."

CONCIERGE GOLF PROGRAMME ALONG THE RHINE AND DANUBE

Imagine if there was a way to combine your luxury river cruise on the Rhine or the Danube visiting some of Europe's most iconic countries such as France, Hungary, Germany, Austria and Slovakia, with the opportunity to indulge your passion for golf at five of the leading European courses that host top marque events. We have created the perfect programme to enable you to do just that!

Our 9 & 10 night exclusive golf and river cruise packages include a 3-night pre or post stay in the fairy-tale cities of Prague or Budapest when cruising the Danube, or 2 nights in Amsterdam when cruising the Rhine. On your 7 night cruise, not only will you enjoy our full cruise experience with all of its choices and inclusions but also a round of golf including lunch in the clubhouse.

TRANSFERS BETWEEN GOLF COURSES & SHIP

Mercedes V Class vans comfortably carrying up to 7 passengers and their equipment transport you between ship and course. To enhance your comfort, enjoy complimentary WiFi and bottled water throughout the journey.

Offering a full Concierge Service, your driver will accompany you throughout the programme, following the ship's itinerary to be able to pick you up from the ship and bring you back, even if the ship has sailed to another port.





RENTAL OPTIONS

GOLF CLUBS

TITLEIST	
Driver, 3 Wood, 5 Wood, 21° Rescue, API Irons 5-PW, 56° wedge, Putter	£120

BUGGIES AND ELECTRIC TROLLEYS

GOLF COURSE	E TROLLEY	BUGGY
Albatross	£15	£35
Bad Griesbach	£15	£35
Diamond Country Club	£15	£35
Penati Golf Resort	£15	£35
Pannonia Country Club	£15	£35
The Royal Haagsche Golf Club	£15	N/A
The Hilversumsche Golf Club	£15	£35
Golf Club Hanau Wilhelmsbad	£15	£35
Golf Club International Soufflenheim	£15	£35
Golf Club Le Kempferhof	£15	£35

ALTERNATE GOLF COURSES

Occasionally one of our Golf courses will be hosting a European Tour event, will be closed for maintenance, or could be booked out for a corporate day. Should that be the case we have selected some other courses to be played as an alternative. The courses all meet the same stringent selection criteria as our main courses, and are also beautiful courses to play.



GOLF PROGRAMME

Included:

- ◆ Full Concierge Service
- ◆ 5 rounds of golf per golfer
- ◆ A la Carte Lunch at each golf club, including complimentary beer & wine
- ◆ 1 pull trolley per golfer per round
- ◆ 1 range token per round
- ◆ 1 Welcome Pack, including a dozen Titleist Pro V1 golf balls per golfer, 1 Pitch Repair Tool, 5 course guides, and a leather shoe bag
- ◆ Club cleaning after each round
- ◆ Automatic entry to the Tour Order of Merit

Not included:

- ◆ Travel Insurance
- ◆ Electric trolleys & buggies
- ◆ Gratuities
- ◆ Golf balls, tees, rented clubs and lessons

Please Note:

- The Golf Programme can only be booked in conjunction with a cruise package
- Final Payment is due at the same time as the cruise package. Please see page 177 for full terms and conditions.

For full details please call **0800 320 2335** or visit **www.amawaterways.co.uk**



HARTL RESORTS BECKENBAUER COURSE



DIAMOND COUNTRY CLUB DIAMOND COURSE



PANNONIA COUNTRY CLUB



PENATI COUNTRY CLUB LEGENDS COURSE

THE DANUBE CONCIERGE GOLF PROGRAMME

AVAILABLE ON THE ROMANTIC DANUBE & MELODIES OF THE DANUBE.

10 night, Golf, Cruise & Land Package from £4,143 per golfer.

Fares for non-golfers can be found on pages 71 & 75.

ALBATROSS GOLF CLUB ALBATROSS COURSE
PRAGUE, CZECH REPUBLIC -
HOST OF THE CZECH OPEN

Designed by Keith Preston, and opened in 2009, the golf course occupies an area of more than 80 hectares (197,684 acres) and is situated on a hillside bordering the Cesky Kras Nature Reserve. There are seven lakes on the course covering more than 20,000 square metres, 65 sand traps and more than 1200 newly planted mature trees adorning the landscape. The leading golf course in the Czech Republic as voted for by Golf Digest, this wonderful resort will start your golfing tour off in perfect style.

HARTL RESORTS BECKENBAUER COURSE
BAD GRIESBACH, GERMANY -
HOST OF THE PORSCHE EUROPEAN OPEN

Regal golfing pleasure on lush greens and perfect fairways - this championship course, created by former Masters champion Bernhard Langer, seems to be one with the meadow landscape surrounding the small river Rott and was awarded a "world class" rating within one year of opening. The 18 holes in Penning, right beside the Audi Golf Course, do indeed pack a punch. They don't hold back when it comes to challenges, but also offer sufficient opportunities for some serious success.

DIAMOND COUNTRY CLUB DIAMOND COURSE
ATZENBRUGG, AUSTRIA -
HOST OF THE LYONESS AUSTRIAN OPEN

This Championship course, host of the Lyoness Open powered by Sporthilfe Cashback Card, on the outskirts of Vienna, challenges every player's ability, thanks to the need for good course management and that important element of water.

Experience the European Tour standard which allows for precise shots in challenging settings, far from those packed fairways. The trim cut grass and perfectly kept greens allow for the best games of golf, surrounded by beautiful and fair water hazards.

PENATI COUNTRY CLUB LEGENDS COURSE
SENICA, SLOVAKIA -
HOST OF THE SLOVAKIAN OPEN

This 18-hole golf course has been built according to plans authored by Nicklaus Design, one of the world's leading design firms. The Nicklaus Design LEGEND COURSE complies with USGA standards at the world PGA level. 60% of the world's golf courses which host PGA tournaments have been designed by Nicklaus Design. Along with many other scenic features, this course counts the longest hole in Europe among its challenges.

PANNONIA COUNTRY CLUB
BUDAPEST, HUNGARY -
HOST OF THE HUNGARIAN OPEN

The 18-hole golf course of Pannonia Golf & Country Club was designed by the famous Austrian course designer Hans G. Erhardt. The golf course lies in a valley so the varied forms of its fairways provide a great golf experience. Lakes come into play at 8 holes and pin placements may also present a challenge at the hilly greens. With 6 different tee-boxes, both beginners and advanced players can get a true and fair idea of their golf skills. The natural environment and the beautiful, carefully maintained course inspires golf players to hit great shots.

ROMANTIC DANUBE

DAY	CITY	GOLF COURSE	NON-GOLF OPTION
1	Prague, Czech Republic	No Golf	Arrival / At Leisure
2	Prague	No Golf	Excursions
3	Prague	Albatross Golf Course	At Leisure
4	Prague (AM)		Transfer To Regensburg
4	Vilshofen (PM), Germany		🚢 EMBARKATION
5	Vilshofen	Hartl Resorts Beckenbauer Course	Excursions
6	Linz, Austria	Diamond Country Club	Excursions
7	Weissenkirchen, Austria	No Golf	Excursions
8	Vienna, Vienna	No Golf	Excursions
9	Bratislava, Slovakia	Penati Golf Course	Excursions
10	Budapest, Hungary	Pannonia Country Club	Excursions
11	Budapest		🚢 DISEMBARKATION

MELODIES OF THE DANUBE

DAY	CITY	GOLF COURSE	NON-GOLF OPTION
1	Budapest, Hungary		🚢 EMBARKATION
2	Budapest	Pannonia Country Club	City Tour
3	Bratislava, Slovakia	Penati Golf Resort	City Tour
4	Vienna, Austria	No Golf	City Tour
5	Weissenkirchen, Austria	Diamond Country Club	Excursions
6	Linz, Austria	No Golf	Excursions
7	Passau, Germany	Hartl Resorts	Excursions
8	Vilshofen, Germany		🚢 DISEMBARKATION
9	Prague, Czech Republic	No Golf	Excursions
10	Prague	Albatross Golf Resort	At Leisure
11	Prague	No Golf	At Leisure / Departure

Please call us for Golf Programme Prices

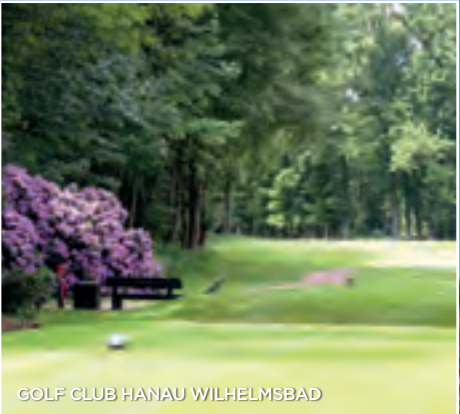

GOLF CLUB HANAU WILHELMSBAD



THE HILVERSUMSCHE GOLF CLUB



GOLF CLUB INTERNATIONAL SOUFFLENHEIM

THE RHINE CONCIERGE GOLF PROGRAMME

AVAILABLE ON ENCHANTING RHINE & CAPTIVATING RHINE.

9 night, Golf, Cruise & Land Package from £3,944 per golfer.
Fares for non-golfers can be found on pages 103 & 107.

THE ROYAL HAAGSCHE GOLF CLUB

WASSENAAR, NETHERLANDS

Ranked No.1 in Holland, No.2 in Continental Europe, and 98th in the world. Host of the Dutch Seniors Open, Former host of the Dutch Open. Their motto is very simple - "At the Royal Hague Golf & Country Club, we pride ourselves on sportsmanship, hospitality and respect. To put it simply, the Haagsche is: Committed to the values and the spirit of the game of golf." The current course was designed in 1938, by the famous golf course architects Harry Colt and C.H. Alison. Although Alison was responsible for most of the design, as evidenced by the slightly larger bunkers and more extreme nature, the course is still counted as one of the finest Colt designed courses in Europe. The design of the golf course makes use of the naturally undulating dune landscape. Each hole offers a completely different view and a new and surprising challenge. Teeing off on the 18th gives the golfer a wonderful view of the clubhouse and terrace.

THE HILVERSUMSCHE GOLF CLUB

HILVERSUM, NETHERLANDS

This club is one of the most exclusive in the Netherlands, but is available to our golfing guests. Ranked 49th in Europe, the course is an original Colt design that has been upgraded by Kyle Phillips to prep it for the future generations of Golfers. The heathland course of the Hilversumsche last hosted the Dutch Open from 2010 -2012 with Martin Kaymer, Simon Dyson and Peter Hanson each triumphant over the beautiful Phillips and Colt designs.

GOLF CLUB HANAU WILHELMSBAD

HANAU, GERMANY

A former European Tour venue, this member of the leading golf courses of Germany prides itself on quality throughout its operations, from the course to the 19th hole. Built in 1961, the course has matured into one of Germany's most beautiful Parkland courses. Located within the 300-year-old estate of the Prince von Hessen, this is a true beauty of a golf course and one of the best in the Region.

GOLF CLUB INTERNATIONAL SOUFFLENHEIM

SOUFFLENHEIM, FRANCE

Right at the heart of Europe and Alsace, world class golfer Bernhard Langer has created a golfing paradise a mere 25 minutes from Baden-Baden and from Strasbourg. The 33 greens and 18 lakes lie harmoniously nestled into the serene water meadow landscape of the Upper Rhine, surrounded by delightfully peaceful natural scenery and a world away from the hustle and bustle. In addition to the spectacular 18-hole championship course, members and guests have the choice between an attractive 9-hole course and a 6-hole short course, as well as luxurious practice facilities, all located within the 140 hectare site.

GOLF CLUB LE KEMPFERHOF

PLOBSHEIM, FRANCE

Ranked 49th in continental Europe, this 1990 Robert von Hagge design is one of the most beautiful courses in the Alsace region. Situated in a beautiful 85 Hectare park, the 19th century former hunting lodge doubles as a Golf Club. Plenty of Water and bold bunkering typify this very challenging golf course. Situated just a few miles south of the capital city of Europe, Strasbourg, the course is the perfect complement to the region.

CAPTIVATING RHINE

DAY	CITY	GOLF COURSE	NON-GOLF OPTION
1	Amsterdam, The Netherlands	No Golf	Arrival / At Leisure
2	Amsterdam	Hilversumsche Golf Club	At Leisure
3	Amsterdam	Den Haagsche Golf Club	⚓ EMBARKATION
4	Amsterdam	No Golf	Excursions
5	Cologne, Germany	No Golf	Excursions
5	Koblenz, Germany	No Golf	Excursions
6	Rhine Gorge	No Golf	Excursions
6	Rudesheim, Germany	Golf Club Hanau Wilhelmsbad	Excursions
7	Mannheim, Germany	No Golf	Excursions
8	Strasbourg, France	Soufflenheim	Excursions
9	Breisach, Germany	Kempferhof Golf Club	Excursions
10	Basel, Switzerland		⚓ DISEMBARKATION

ENCHANTING RHINE

DAY	CITY	GOLF COURSE	NON-GOLF OPTION
1	Basel, Switzerland	No Golf	⚓ EMBARKATION
2	Breisach, Germany	Kempferhof Golf Club	Excursions
3	Strasbourg, France	Soufflenheim	Excursions
4	Mannheim, Germany	No Golf	Excursions
4	Rudesheim, Germany		Excursions
5	Rhine Gorge	No Golf	Excursions
5	Koblenz, Germany	No Golf	Excursions
6	Cologne, Germany	No Golf	Excursions
7	Amsterdam, The Netherlands	No Golf	Excursions
8	Amsterdam	Den Haagsche Golf Club	⚓ DISEMBARKATION
9	Amsterdam	Hilversumsche Golf Club	At Leisure
10	Amsterdam	No Golf	At Leisure / Departure

Please call us for Golf Programme Prices



UNIQUE WINE EXPERIENCES

Uncork local traditions, savour intense flavours and enjoy palate-pleasing adventures on our exclusive Wine Cruises. Drink up the beauty of the world's most intoxicating wine regions and award-winning vineyards in such places as Austria's Wachau Valley, France's iconic Bordeaux area and Portugal's Douro Valley. And expect to be wined and dined with multi-course, regionally-inspired cuisine and wine pairings. During our exclusive wine-themed cruises, AmaWaterways invites acclaimed experts to enhance already spectacular itineraries by overseeing special tastings, leading excursions to wineries and vineyards and explaining the nuances of the region's wine-making traditions.

On all our river cruises, guests enjoy a full plate of exclusive shore excursions to highlight the remarkable sights of each destination. But by joining one of our 50 special wine-themed cruises, guests will see these sights while imbibing in local traditions—all at no additional cost. It is the perfect blend of wine-related experiences and excursions in grand capitals and charming towns.



TASTING NOTES

Whet your appetite by filling up on inspiring, engaging and informational stories by visiting CONNECTIONS on amawaterways.co.uk—including Sauternes from France's Bordeaux region and Port from Portugal's Douro Valley.

SAUTERNES WINE

Celebrate life's sweetest moments with an intoxicating pairing of ultra-rich, honeyed Sauternes wine. The highly aromatic white Bordeaux wine delivers full flavours, remarkable intensity and complexity with layers of exotic fruit, honey and acidity. Although sweet, it pairs perfectly with savoury flavours—like peppery cuisine, Roquefort terrine and red meat—to bring out as its many delightful nuances.

PORT WINE

Produced exclusively in Portugal's Douro River Valley, Port is a sweet, fortified wine often served with dessert or paired with a rich cheese. From youthful Ruby Port to aged Tawnies and distinguished Vintage Ports—the signature Portuguese drink features incomparable richness, complexities and strong aromas, a long finish and a high level of alcohol content. Intense tannins and fruity flavours merge into a bolder velvety flavour, a blend in varying degrees of berries, caramel, chocolate and nuts.





WITNESS THE TIME-HONOURED TRADITIONS OF WINEMAKING

Discover the differences between a Moselle Riesling from Germany and an Alsatian Riesling from France on the “Rhine & Moselle Splendours.” Or be treated to an in-depth understanding on the differences between Bordeaux’s Left Bank and Right Bank wines as you taste your way through Bordeaux. Whether you are a wine enthusiast or enjoy a sip here or there, AmaWaterways’ special wine-themed cruises delve deeply into the rich tapestry of tradition from the winemakers themselves.

YOUR OWN PERSONAL WINE HOST

When you travel on an AmaWaterways wine-themed cruise, you’ll be joined by one of our wine hosts—industry experts who enthusiastically share their passion and love of wine with you. Professional winery owners, winemakers, wine instructors and certified sommeliers from renowned wineries, our insightful wine hosts lead you through wine tastings on board and accompany you to local wineries and vineyards where you’ll learn first-hand from regional European experts.

FOOD & WINE PAIRING—A UNIQUE ART

A bite of food and a sip of wine intertwine to ignite your taste buds. But it’s not just any wine; it is wine perfectly chosen to meld with the food on your plate and on your palate. Have fun learning how to really tantalise your taste buds at a food and wine pairing dinner designed to heighten the dynamic relationship between the two. Rosemary-crusting lamb? A clear match for Châteauneuf-du-Pape. Oysters on the half shell? Try a Loire white. Rich chocolate cake? Port is in order.

EAT, DRINK AND BE MERRY



RENOWNED WINE REGIONS

Explore illustrious vineyard-dotted landscapes such as Austria's Wachau Valley, France's iconic Bordeaux area, Portugal's Douro Valley or Germany's Moselle Valley.



EXCLUSIVE PRIVATE CELLAR TOURS

Exclusive tours to historic wine cellars will leave guests thirsty for more as you participate in tastings and conversations with local owners.



"INSIDER'S VIEW" WITH THE EXPERTS

Qualified wine experts bring along premium, hand-selected wines to be served during meals, tastings and discussions on production and consumption.



PREMIER LOCAL VINEYARDS

Stunning vineyards are best seen up close. Stroll through on a warm summer day or take in the vivid colours of the grape harvest during the fall for a special treat.



UNIQUE WINE TASTINGS

Wine cruises are all about indulging. Enjoy unique tastings on the ship and during special excursions at a variety of local venues, including taverns, vineyards and wineries.



AUTHENTIC CUISINE & WINE PAIRINGS

Enjoy hearing about how to really tantalise your taste buds with the perfect pairing of wine and food.

WINE CRUISES

In addition to a full-plate of onboard activities and immersive shore excursions, AmaWaterways wine cruises add a unique epicurean dimension to a variety of itineraries at no additional cost. Join one of these wine cruises with a special wine host and be treated to a menu of exclusive wine and culinary experiences designed to delve deeper into the wonderful flavours and tastes of Europe.



ROMANTIC DANUBE Page 68

7-night Vilshofen to Budapest cruise

START CITY	EMBARK DATE	SHIP NAME	CRUISE FARE FROM (PER PERSON)
Vilshofen	Mar 23	AmaSerena	£1,778
Budapest*	Mar 23	AmaViola	£1,778
Budapest*	Mar 30	AmaSerena	£1,845
Budapest*	Jul 20	AmaSerena	£2,311
Budapest*	Aug 3	AmaSerena	£2,311
Budapest*	Oct 26	AmaSerena	£2,178
Vilshofen	Nov 2	AmaSerena	£2,111
Budapest*	Nov 2	AmaViola	£2,111
Budapest*	Nov 4	AmaLea	£2,111
Vilshofen	Nov 9	AmaViola	£2,045
Vilshofen	Nov 11	AmaLea	£1,978

* For departures beginning in Budapest, refer to *Melodies of the Danube* on page 72.



EUROPE'S RIVERS & CASTLES Page 92

7-night Nuremberg to Luxembourg cruise

START CITY	EMBARK DATE	SHIP NAME	CRUISE FARE FROM (PER PERSON)
Nuremberg	Apr 5	AmaDante	£1,911
Nuremberg	Jul 19	AmaDante	£2,311



RHINE & MOSELLE SPLENDOURS Page 108

7-night Luxembourg to Basel cruise

START CITY	EMBARK DATE	SHIP NAME	CRUISE FARE FROM (PER PERSON)
Luxembourg	Apr 12	AmaDante	£2,045
Luxembourg	Nov 8	AmaDante	£2,045



ENCHANTING RHINE Page 104

7-night Basel to Amsterdam cruise

START CITY	EMBARK DATE	SHIP NAME	CRUISE FARE FROM (PER PERSON)
Amsterdam*	Mar 24	AmaPrima	£1,778
Amsterdam*	Mar 26	AmaStella	£1,778
Basel	Mar 31	AmaPrima	£1,845
Basel	Apr 2	AmaStella	£1,911
Amsterdam*	Apr 1	AmaSonata	£1,911
Basel	Apr 8	AmaSonata	£1,978
Amsterdam*	Aug 13	AmaStella	£2,311
Basel	Nov 5	AmaKristina	£2,045
Amsterdam*	Nov 5	AmaStella	£2,045
Basel	Nov 12	AmaStella	£1,978
Basel	Nov 19	AmaKristina	£1,978
Amsterdam*	Nov 17	AmaPrima	£1,978

* For departures beginning in Amsterdam, refer to *Captivating Rhine* on page 100.



Fares shown are per person, based on double occupancy of a category E stateroom. For other categories and details, please refer to the relevant itinerary pages referred to above.



TASTE OF BORDEAUX *Page 46*

7-night round-trip Bordeaux cruise

START CITY	EMBARK DATE	SHIP NAME	CRUISE FARE FROM (PER PERSON)
Bordeaux	Mar 29	AmaDolce	£2,111
Bordeaux	Apr 5	AmaDolce	£2,245
Bordeaux	Apr 12	AmaDolce	£2,311
Bordeaux	Jun 28	AmaDolce	£2,578
Bordeaux	Jul 12	AmaDolce	£2,511
Bordeaux	Aug 9	AmaDolce	£2,511
Bordeaux	Aug 16	AmaDolce	£2,578
Bordeaux	Nov 8	AmaDolce	£2,178
Bordeaux	Nov 15	AmaDolce	£2,178



COLOURS OF PROVENCE *Page 54*

7-night Lyon to Arles cruise

START CITY	EMBARK DATE	SHIP NAME	CRUISE FARE FROM (PER PERSON)
Lyon	Mar 22	AmaCello	£2,045
Lyon	Apr 5	AmaCello	£2,245
Lyon	Nov 1	AmaCello	£2,245
Lyon	Nov 8	AmaCello	£2,178



PARIS & NORMANDY *Page 50*

7-night round-trip Paris cruise

START CITY	EMBARK DATE	SHIP NAME	CRUISE FARE FROM (PER PERSON)
Paris	Mar 22	AmaLyra	£2,045
Paris	Mar 29	AmaLyra	£2,111
Paris	Jul 19	AmaLyra	£2,511
Paris	Aug 2	AmaLyra	£2,511
Paris	Nov 8	AmaLyra	£2,178



ENTICING DOURO *Page 58*

7-night Douro cruise

START CITY	EMBARK DATE	SHIP NAME	CRUISE FARE FROM (PER PERSON)
Porto	Jul 10	AmaVida	£2,445
Porto	Aug 7	AmaVida	£2,445
Porto	Aug 14	AmaVida	£2,445
Porto	Nov 6	AmaVida	£2,311
Porto	Nov 13	AmaVida	£2,178



EXPLORE PREMIER VINEYARDS UP-CLOSE



CHRISTMAS CRUISES

From Nuremberg's magical Christmas Markets with its iconic red and white striped booths to Strasbourg's charming white storks, a visit to the Christmas Markets are one of the most special traditions of the season. Majestic Christmas trees strung with thousands of lights, set against the backdrop of some of Europe's most stunning architecture, invite travellers and locals alike to make merry and get into the eggnog-swilling spirit. Wander through the magical markets enjoying whimsical artisanal gifts and the intoxicating aroma of hot cocoa and sugar plums. Be swept up by the lovely melodies of orchestras and choirs.

You'll also learn about age-old traditions along the way. Discover the Czech legends of Mikuláš and Krampus while in Prague or Český Krumlov. Bring home a special souvenir in the form of Nuremberg's traditional prune men and women. Embrace royal holiday traditions at Vienna's Schönbrunn Palace and at Regensburg Thurn and Taxis, one of Bavaria's most romantic. With so much to offer, why stay home for the holidays.



GET SWEEPED UP IN THE MAGIC

Zalig Kerstfeest, Froehliche Weihnachten, Joyeux Noël and Schöni Wiehnachte—all mean Merry Christmas in Dutch, German, French and Swiss, so get ready to hear these sincere greetings as you experience the deep-rooted traditions and heart-warming cuisine of Europe at this most wonderful time of the year. You're sure to have a holly, jolly good time as you get swept up in an intoxicating blend of nostalgia because the holidays really come to life at Europe's legendary Christmas Markets.

CHESTNUTS ROASTING ON AN OPEN FIRE

Join together with friends and loved ones on one of our very special Christmas Cruises, and do what the Europeans have been doing for centuries—gather at the markets, warm up with a mug of steamy vin chaud in France or glühwein in Germany, shop for one-of-a-kind handcrafted treasures and celebrate the true spirit of the season.

- ◆ **Iconic Christmas Markets** - Budapest to Nuremberg *Page 128*
- ◆ **Magical Christmas Markets** - Nuremberg to Vienna *Page 132*
- ◆ **Christmas Markets on the Rhine** - Amsterdam to Basel *Page 136*



A TIMELESS CHRISTMAS MARKET

One of the largest and most popular in all of Europe, Nuremberg's Christmas Market harks back to bygone days. Dating back to at least the early 1600s, the Nuremberg Christmas Market draws in both locals and travellers from near and far. Over 180 wooden booths festively adorned offer up artisanal goodies of all kinds. One of the most notable are the prune men and women figurines made with wire, walnuts for heads and dried prunes for bodies. They come in hundreds of action poses—kissing couples, cooks and waiters, and even skateboarders and piano players. An old Nuremberg saying goes "With a prune man in your house, money and happiness stay, too."

Music is performed live on stage, as opposed to being piped through speakers. Plastic decorations and machine manufactured gifts are banned. An old-fashioned carousel, a Ferris wheel, steam train and nativity scene trail are can't-miss spots. And a sighting of the angelic Christkind played by a blonde-haired young woman in a magnificent gold and white robe, will warm your heart.

Read more about Europe's Christmas Markets by visiting CONNECTIONS on amawaterways.co.uk.





EXTEND YOUR STAY

Since you're already planning on going on holiday, why not make the most of your travels and extend your trip a few days with one of our popular land programmes?

With a few extra days you can opt to shop along Zurich's glittering Bahnhofstrasse, promenade across Prague's romantic Charles Bridge, or discover legendary cities like Paris where you can indulge in a day strolling the Champs-Élysées, the Musée d'Orsay, and enjoying a croissant in a quaint café. How about visiting Transylvania's famous Bran Castle, which is forever linked with the legend of Dracula, as well as Peleş Castle, considered by many to be one of the most stunning in Europe. Or spend time in Barcelona, home to Gaudi's imaginative architectural creations. You can also spend additional time in cities you are visiting on your cruise for a more immersive experience.

And when you plan a land programme with us, you can rest assured knowing that we'll take care of all your needs, booking the best hotels and ensuring that your Cruise Manager will be there the entire time.



NOTRE DAME CATHEDRAL, PARIS

EUROPE HOTELS

With our carefully crafted pre- and post-cruise land programmes, you can spend even more time in world-class destinations. We've picked hotels conveniently located near the major sites and with our Cruise Manager accompanying you throughout both your cruise and land programme, you'll be well taken care of throughout your journey.

AMSTERDAM, THE NETHERLANDS	Sofitel Legend the Grand Amsterdam or Amstel Intercontinental
BARCELONA, SPAIN	Le Méridien Barcelona
BASEL, SWITZERLAND	Grand Hotel Les Trois Rois
BORDEAUX, FRANCE	InterContinental Bordeaux Le Grand Hôtel
BRAȘOV, ROMANIA	Kronwell Brașov Hotel
BUCHAREST, ROMANIA	Athenee Palace Hilton
BUDAPEST, HUNGARY	Sofitel Budapest Chain Bridge Upgrade to the Four Seasons available; ask for details
LISBON, PORTUGAL	InterContinental Lisbon Upgrade to the Four Seasons available; ask for details
LOIRE VALLEY, FRANCE	Hotel Novotel Amboise
LUCERNE, SWITZERLAND	Hotel Schweizerhof Lucerne OR Radisson Blu Hotel
LYON, FRANCE	Hotel Cour des Loges
MADRID, SPAIN	The Westin Palace Madrid
MUNICH, GERMANY	Hotel Bayerischer Hof
NUREMBERG, GERMANY	Le Méridien Grand Hotel Nuremberg
PARIS, FRANCE	Paris Marriott Opera Ambassador Hotel OR InterContinental Paris Avenue Marceau OR Renaissance Paris Le Parc Trocadero Hotel OR Renaissance Paris Arc de Triomphe Hotel
PORTO, PORTUGAL	The Yeatman Hotel
PRAGUE, CZECH REPUBLIC	InterContinental Prague OR Hotel Cosmopolitan Prague OR Hilton Prague Old Town Upgrade to the Four Seasons available; ask for details
VIENNA, AUSTRIA	InterContinental Vienna
ZURICH, SWITZERLAND	Hotel Schweizerhof Zurich OR Zurich Marriott Hotel OR Zurich Steigenberger OR Zurich Eden Au Lac

Note: Hotels are subject to change.



WESTIN PALACE, MADRID



GRAND HOTEL LES TROIS ROIS, BASEL



SOFITEL BUDAPEST CHAIN BRIDGE

FRANCE AND PORTUGAL

Discover the breathtaking beauty and riches found along the Garonne, Dordogne, Seine and Rhône in France, as well as the Douro in Portugal and Spain.

The Seine and Rhône

The Seine rises in northeastern France near Dijon, flows through Paris, and continues westward through Normandy to the English Channel. The Rhône flows from its source in the Swiss Alps and travels south to the Mediterranean, linking thousands of vineyards and wineries in southeastern France.

The Garonne, Dordogne and Gironde Estuary

In the corner of southwestern France, the Garonne and Dordogne rivers merge together to form the Gironde Estuary, which naturally divides the Bordeaux region into the Left and Right banks. Travellers from around the world flock to this region that is well known for its many gastronomic delights.

The Douro

This major river of the Iberian Peninsula flows from its source in Spain to its outlet in Northern Portugal. It is here that river cruisers will discover the Douro River Valley, the birthplace of Port wine and a designated UNESCO World Heritage Site.



NOTRE-DAME CATHEDRAL IN PARIS ON THE SEINE



THE GARONNE & DORDOGNE RIVERS



TASTE OF BORDEAUX

ENJOY ONE OF THE WORLD'S RENOWNED WINE MAKING REGIONS WITH
A CRUISE FROM BORDEAUX

7 NIGHTS • BORDEAUX ROUNDTrip



Begin in Bordeaux, the capital of Aquitaine in Southwestern France and one of the world's undisputed wine capitals. You'll discover stately châteaux, abundant vineyards and stunning scenery as you sail along the Garonne River and its surrounding estuaries, calling upon port cities like Cadillac, Pauillac, Bourg and Libourne. Enjoy tastings of some of the region's most distinguished wines and visit notable sights before returning to Bordeaux to conclude your cruise.

DAILY PROGRAMME FEATURES

DAY	DESTINATION	ACTIVITIES
1	Bordeaux, France	✳ EMBARKATION
2	Cadillac, France	Sauternes wine tasting and Roquetaillade Castle
3	Pauillac, France	Grand Cru Classé wine tasting and scenic vineyard tour
4	Blaye, France	Blaye Citadel visit OR Blaye bike tour OR Prehistoric cave art
	Bourg, France	Blaye to Bourg bike tour Bourg walking tour, Carriage Museum and exclusive Bourg wine festival
5	Libourne, France	Saint-Émilion excursion and Grand Cru Classé wine tasting OR Saint-Émilion bike tour and wine tasting
6	Libourne	Château de Vayres OR French Bastide town and market with tastings OR Countryside hike with wine tasting and hors d'oeuvres Château de Montaigne OR Fronsac wine tasting
7	Bordeaux	City tour and Wine Museum OR Bordeaux bike tour
8	Bordeaux	⬇ DISEMBARKATION

✳ Embark 7-Night Cruise

⬇ Disembark 7-Night Cruise

Note: Bike tours and hikes subject to weather and seasonality.

For full itinerary details, visit www.amawaterways.co.uk



BORDEAUX CAFÉ



BORDEAUX, FRANCE



SAINT EMILION, FRANCE

INCLUDED FEATURES

- » 7 nights deluxe cruise accommodation in riverview stateroom or suite – most staterooms offer French balconies
- » Entertainment-On-Demand in all staterooms featuring free high-speed internet access, movies, a music library and English language TV stations
- » Fine dining, including unlimited complimentary hand-selected wines, beer and soft drinks with lunch and dinner on board
- » Multiple dining venues, including The Chef's Table specialty restaurant featuring our unique tasting menu
- » **NEW FOR 2018 – Sip & Sail daily cocktail hour with complimentary wine, beer, spirits and soft drinks**
- » Welcome Cocktail, Welcome Dinner, La Chaîne des Rôtisseurs Dinner, Captain's Cocktail and Gala Dinner
- » Complimentary Wi-Fi access on board
- » Guided shore excursions in every port, including Special Interest Tours, hiking and biking tours
- » Onboard live entertainment, theme dinners, cooking demonstration and more
- » Complimentary bicycles, helmets and Nordic walking sticks
- » Services of a professionally trained Cruise Manager throughout your cruise and land stay
- » Transfers between hotel and ship are included with the purchase of cruise and land package.

YOUR ITINERARY

Day 1, EMBARKATION – BORDEAUX, FRANCE. Arrive at your luxurious ship, where you will gather this evening for a Welcome Dinner. (D)

Day 2, CADILLAC. Visit the impressive Castle of Roquetaillade, an amazingly preserved masterpiece of medieval military architecture owned by the same noble family for 700 years. Afterwards, travel to the Sauternes wine region to either Château de Rayne Vigneau or Château Guiraud to taste the highly prized golden-hued sweet wines produced here. (B,L,D)

Day 3, PAUILLAC. Pauillac, a lovely village on the Left Bank of the Gironde Estuary, is gateway to the famed Médoc region renowned for producing some of the world's finest Bordeaux wines. You will see some of the most beautiful and famous wine estates, including Château Latour, Château Mouton Rothschild, Château Lafite Rothschild and Château Pichon Longueville. You'll then visit either Château Gruaud Larose or Château Léoville Poyferré for a tasting of Grand Cru wines. (B,L,D)

Day 4, PAUILLAC – BLAYE – BOURG. Once in Blaye, you can join a tour of its 17th-century citadel, a UNESCO World Heritage Site. For a more active excursion, take a bike ride from Blaye through the idyllic French countryside. Alternatively, visit a prehistoric cave, Pair non Pair, offering one of the best examples of art made by prehistoric man. During the afternoon, you can cruise to Bourg or join a bike tour along Santiago's path—a

famous pilgrimage route—to Bourg. While in the ancient village of Bourg, visit the Carriage Museum, which houses a wonderful collection of horse-drawn vehicles and then explore the underground passageways that lead you to the immense oil tanks from the Second World War. Later in the day, experience the hospitality of this charming medieval village with an exclusive wine festival complete with live French music, dancing, wine and hors d'oeuvres. (B,L,D)

Day 5, BOURG – LIBOURNE. Libourne provides a gateway to one of Bordeaux's most elite wine regions, Saint-Émilion, known for its picturesque architecture, monuments and celebrated vineyards. Join an excursion to historic Saint-Émilion, and while here, explore the monolithic church carved out of one piece of limestone rock, and then go under the church to discover its catacombs and caves. Afterwards, enjoy a wine tasting at either Château de Ferrand or Château de Pressac. Prefer a more active adventure, pedal through the vineyard-rich countryside to Saint-Émilion and then to Château Soutard for a Grand Cru Classé wine tasting. (B,L,D)

Day 6, LIBOURNE – BORDEAUX. Tour the magnificent Château Vayres, one of the most prestigious historic buildings of Aquitaine, or spend time discovering the Bastide town of Libourne and then stroll through its colourful open-air market tasting some of the region's specialties. For a more active exploration of the countryside,



PLAY AMONG THE INTERACTIVE FOUNTAINS OF THE WORLD'S LARGEST REFLECTING POOL IN BORDEAUX

TASTE OF BORDEAUX

enjoy a hike followed by a wine tasting. Later in the day, you will have two options of excursions. Visit Château de Montaigne, a stunning 14th-century castle that was the family residence of philosopher Michel de Montaigne and enjoy a lovely wine tasting. Alternatively, visit Fronsac, where you can taste some of the regional wines at a grand wine cellar. (B,L,D)

Day 7, BORDEAUX. The breathtaking capital of the wine world, Bordeaux, is a UNESCO World Heritage Site and classified as a “City of Art and History.” You’ll have an opportunity to experience much of the rich culture and architecture on a city tour followed by a visit to the Bordeaux Wine Museum, housed in an awe-inspiring building. Bike enthusiasts will wish to join a tour along the city’s amazing network of bicycle paths. (B,L,D)

Day 8, BORDEAUX – DISEMBARKATION – TOURS. Disembark your ship in Bordeaux. (B)

ENHANCED CRUISES AT NO ADDITIONAL COST



WINE CRUISES (see pages 34–39 for more information)
Add a unique, epicurean dimension to your itinerary.

Complimentary Bonus Features:

- ◆ Special tours and tastings at local wineries and private cellars
- ◆ Learn about winemaking in renowned vineyards
- ◆ Onboard wine pairings with award-winning cuisine
- ◆ A wine expert who leads tastings and discussions

Embark dates: 2018 - Mar 29, Apr 5, Apr 12, Jun 28, Jul 12, Aug 9, Aug 16, Nov 8, Nov 15

LAND PROGRAMME OPTIONS – PRE-CRUISE

PARIS – 2 NIGHTS

Before you board your voyage through the beautiful Bordeaux region, spend some time in the capital of France, the “City of Lights,” Paris. Across three days, tours and hotels are included with time to explore this fantastic city both on tours and in your own time. Visit Notre Dame and then see some of the most famous sights on a panoramic city tour, followed by a photo stop at Champs de Mars for views of the Eiffel Tower. After two nights sampling the delights check out of your hotel with ease, and board a TGV high-speed train that will take you straight to the legendary land of wine blends and monumental architecture – Bordeaux

LAND PROGRAMME OPTIONS – POST-CRUISE

LOIRE VALLEY – 3 NIGHTS

Continue by TGV train to Tours, France. Experience this charming city in the Loire Valley teeming with art, history, lovely gardens and tasty cuisine. On to picturesque Amboise where you can tour the spectacular Renaissance style Château d’Amboise. Its extravagant residences, gardens and Gothic chapel belonged to several French kings in the past. You’ll also discover Château du Clos Luce, Leonardo da Vinci’s last home, where he completed some of his most famous works. On your way back to Paris visit the astonishing Châteaude Chambord. Located at the heart of Europe’s largest enclosed wooded park, its 156-metre façade and 426 rooms make this the largest castle in Loire Valley. Finally, marvel at the residence of seven kings and ten queens of France during your tour of the famous Château de Blois

DATES AND FARES (£)

EMBARK DATE	START CITY	SHIP NAME	7-NIGHT CRUISE
Mar 22	Bordeaux	AmaDolce	£2,045
Mar 29	Bordeaux	AmaDolce	£2,111
Apr 5	Bordeaux	AmaDolce	£2,245
Apr 12	Bordeaux	AmaDolce	£2,311
Apr 19	Bordeaux	AmaDolce	£2,378
May 3	Bordeaux	AmaDolce	£2,511
May 10	Bordeaux	AmaDolce	£2,578
May 17	Bordeaux	AmaDolce	£2,578
May 24	Bordeaux	AmaDolce	£2,578
May 31	Bordeaux	AmaDolce	£2,578
Jun 14	Bordeaux	AmaDolce	£2,578
Jun 21	Bordeaux	AmaDolce	£2,578
Jun 28	Bordeaux	AmaDolce	£2,578
Jul 5	Bordeaux	AmaDolce	£2,511
Jul 12	Bordeaux	AmaDolce	£2,511
Jul 26	Bordeaux	AmaDolce	£2,511
Aug 9	Bordeaux	AmaDolce	£2,511
Aug 16	Bordeaux	AmaDolce	£2,578
Aug 23	Bordeaux	AmaDolce	£2,645
Sep 6	Bordeaux	AmaDolce	£2,711
Sep 13	Bordeaux	AmaDolce	£2,711
Sep 20	Bordeaux	AmaDolce	£2,711
Oct 4	Bordeaux	AmaDolce	£2,645
Oct 11	Bordeaux	AmaDolce	£2,578
Oct 18	Bordeaux	AmaDolce	£2,511
Oct 25	Bordeaux	AmaDolce	£2,378
Nov 1	Bordeaux	AmaDolce	£2,245
Nov 8	Bordeaux	AmaDolce	£2,178
Nov 15	Bordeaux	AmaDolce	£2,178

■ Wine Cruise; visit www.amawaterways.co.uk for detailed itinerary.

Flights: Please call for fares and availability.

Transfers: Bordeaux Airport to Ship (or reverse): from £30 per person.

Cruise fares are per person based on double occupancy in a Cat. E, deluxe outside stateroom with window. To upgrade to a higher category, add per person:

CAT.	DECK	STATEROOM	7 NIGHT
D	Piano	Window	£199
C	Violin & Cello	French Balcony	£599
B	Violin & Cello	French Balcony	£733
A	Violin	French Balcony	£799
A+	Violin	French Balcony	£1,466
Suite	Violin	French Balcony	£1,599

Port Charges: Fares include port charges of £112 per person.

Single Supplement: Categories E – A: add 50% per person; Categories A+ and Suite: add 100% per person. Single supplement may be waived on D and E categories subject to availability. Please check at time of booking.

Bedding: Please select bedding configuration at the time of booking.
Option A: Two twin beds Option B: One large bed (larger than queen size)

Deck Plans: AMADOLCE - See page 168

LAND PROGRAMMES

PRE-CRUISE – 2 NIGHTS PARIS from £600 per person

POST-CRUISE – 3 NIGHTS (2 NIGHTS PARIS, 1 NIGHT LOIRE VALLEY)
from £680 per person

Additional Hotel Nights (prices subject to change due to seasonality):

Prices are per person

Paris: Double occupancy – £170, Single occupancy – £340

Bordeaux: Double occupancy – £140, Single occupancy – £280

Additional hotel nights include portage, breakfast, as well as transfers to/from the ship only in cities where the ship is embarking or disembarking.

Single Supplement: 2 Nights Paris £213 per person
3 Nights (2 Nights Paris, 1 Night Loire Valley) £320 per person

For more information on hotels, please see page 42.

THE SEINE RIVER



PARIS & NORMANDY

7 NIGHTS • PARIS ROUNDTRIP

ENJOY A SEINE RIVER VOYAGE FROM THE STUNNING CAPITAL OF FRANCE, TRAVELLING THROUGH THE HEART OF NORMANDY, BEFORE RETURNING TO THE CITY OF LIGHT, PARIS.

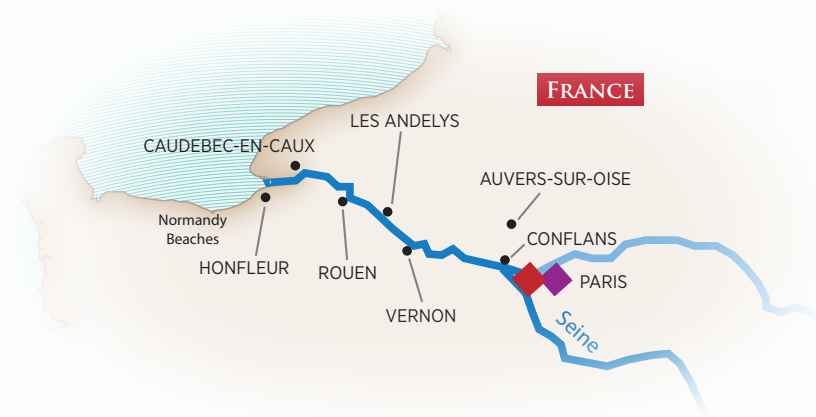

Begin your journey in magical Paris, the “City of Light,” where you will embark upon your luxurious river cruise ship. Visit the village of Giverny, where Monet lived and worked for 43 years, and Honfleur, a charming French harbour town immortalised by generations of artists. Stroll through Rouen, the historic capital of Normandy, then take an unforgettable excursion to the famous Normandy beaches of WWII. Visit Les Andelys, home of Château Gaillard, before returning to beautiful Paris.

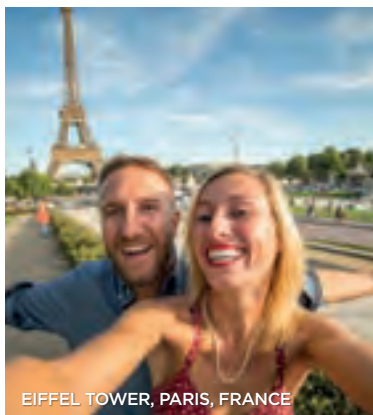

EIFFEL TOWER, PARIS, FRANCE



ROUEN CATHEDRAL, FRANCE

DAILY PROGRAMME FEATURES

DAY	DESTINATION	ACTIVITIES
1	Paris, France	⚓ EMBARKATION
2	Vernon, France	Free time Excursion to Monet's home and gardens in Giverny OR Château de Bizy tour
3	Le Havre, France	Honfleur excursion OR Routes des Abbayes tour OR Le Havre bike tour
4	Caudebec-en-Caux, France	Full-day excursion to Normandy Beaches OR Pays d'Auge excursion
5	Rouen, France	Morning walking tour with Norman specialties tasting OR Rouen bike tour Afternoon Jewish Rouen
6	Les Andelys, France	Scenic cruising Château Gaillard tour OR Les Andelys bike tour OR Château Gaillard hike
7	Conflans, France	Château Malmaison excursion OR Artists' Walk tour of Auvers-sur-Oise
8	Paris	⚓ DISEMBARKATION

⚓ Embark 7-Night Cruise

⚓ Disembark 7-Night Cruise

Note: Monet's home and other attractions in Giverny are closed in March and November. Guests may participate in alternative excursions or visit another city on these cruises. Bike tours and hikes subject to weather and seasonality.

For full itinerary details, visit www.amawaterways.co.uk

INCLUDED FEATURES

- » 7 nights deluxe cruise accommodation in riverview stateroom or suite – most staterooms and suites offer French balconies
- » Entertainment-On-Demand in all staterooms featuring free high-speed internet access, movies, a music library and English language TV stations
- » Fine dining, including unlimited complimentary hand-selected wines, beer and soft drinks with lunch and dinner on board
- » Multiple dining venues, including The Chef's Table specialty restaurant featuring our unique tasting menu
- » **NEW FOR 2018 – Sip & Sail daily cocktail hour with complimentary wine, beer, spirits and soft drinks**
- » Welcome Cocktail, Welcome Dinner, La Chaîne des Rôtisseurs Dinner, Captain's Cocktail and Gala Dinner
- » Complimentary Wi-Fi access on board
- » Guided shore excursions in every port, including Special Interest Tours, hiking and biking tours
- » Onboard live entertainment, theme dinners, cooking demonstration and more
- » Complimentary bicycles, helmets and Nordic walking sticks
- » Services of a professionally trained Cruise Manager throughout your cruise and land stay
- » Transfers between hotel and ship are included with the purchase of cruise and land package

YOUR ITINERARY

Day 1, EMBARKATION – PARIS, FRANCE. Arrive in Paris, one of world's most romantic cities, and board your luxurious ship. (D)

Day 2, VERNON. Sail along the meandering Seine to Vernon, where you will have time to explore at your leisure before either visiting Claude Monet's Gardens in Giverny or Château de Bizy. Art lovers will immediately recognise images immortalised in Monet's most beloved paintings, such as water lilies, Japanese bridges and graceful willow trees, while wandering around his famous gardens and home where he lived for more than four decades. Alternatively, visit Château de Bizy with its majestic courtyard and charming park embellished with fountains. (B,L,D)

Day 3, VERNON – LE HAVRE. Visit the seaside town of Honfleur, renowned for its picturesque harbor, and being an inspirational site for Impressionist painters. If you wish to experience a different kind of inspiration, the Romanesque Normandy Abbey Route will take you to the magnificent Abbaye de Montivilliers and Abbaye du Valasse. For a more active adventure, you can bike through Normandy's picturesque landscape. (B,L,D)

Day 4, CAUDEBEC-EN-CAUX – NORMANDY BEACHES. Experience the Normandy region with one of three tours. For those wishing to go to the American sector of the

historic Normandy Beaches, you will visit the cemetery at Colleville-sur-Mer, Omaha Beach, the artillery battery at Longues-sur-Mer and the village of Arromanches, where the remains of the floating harbour used during the WWII landings can be seen. If you prefer, you can tour the Gold and Juno beaches in the British and Canadian sectors, where you will visit Ranville Cemetery, Pegasus Bridge, the Canadian cemetery at Beny-sur-Mer, the WWII museum in Courseulle and finally Arromanches. As an alternative experience, travel through beautiful countryside of Pays d'Auge, surrounded by the apple orchards of the famed Cider Route. Visit the 17th-century Château du Breuil, one of the most prestigious Calvados distilleries and taste a broad range of ciders and Calvados, before visiting Cambremer and Beuvron-en-Auge, voted one of the most beautiful towns in France. (B,L,D)

Day 5, ROUEN. Spend the morning enjoying medieval Rouen with a choice of three excursions. Join a walking tour past the imposing Notre Dame Cathedral, painted numerous times by Monet, and see the square where Joan of Arc was martyred, as well as the Medieval Quarter and Great Clock. For those who wish to be more active, you can join a biking or hiking tour around the city. Later in the day, you can explore the Jewish area of Rouen. (B,L,D)



MONET'S GARDENS, GIVERNY, FRANCE

PARIS & NORMANDY

Day 6, LES ANDELYS – CONFLANS. A mid-day stroll along the river in Les Andelys offers beautiful views of the Seine Valley's dramatic white cliffs, centuries-old half-timbered houses and the hilltop ruins of Château Gaillard. Visit the former stronghold of Richard the Lionheart on a standard tour, or go on a more active adventure and hike there. For those who wish to explore the area on two wheels, join a guided bike tour through Les Andelys. (B,L,D)

Day 7, CONFLANS – PARIS. Visit Château Malmaison, the former home of Napoleon and Josephine Bonaparte. You'll learn what life was like for the Bonapartes and how Josephine endeavored to transform the large estate into "the most beautiful and curious garden in Europe." Alternatively, travel to Auberge Ravoux in the heart of Auvers-sur-Oise, the last home of artist Vincent van Gogh. His spirit still lingers in his former attic rooms at the Ravoux Inn. The mere 70 days Van Gogh spent in Auvers-sur-Oise were astonishingly prolific as he painted more than 70 works here before his death. (B,L,D)

Day 8, DISEMBARKATION – PARIS. Disembark your ship in Paris and prepare for your journey home. (B)

SEE MORE OF FRANCE

Select departures may be combined with *Colours of Provence* (page 54).

Ask for availability.

LAND PROGRAMME OPTIONS – POST-CRUISE

PARIS – 2 NIGHTS

After disembarking the ship enjoy a panoramic tour of Paris taking in many fantastic sights, such as the Pantheon, Champs de Mars, Eiffel Tower and Arc de Triomphe. Afterwards, you will visit one of the city's most renowned museums, the Musée d'Orsay, built in a former railway station on the Left Bank. Its collection of Impressionist and Post-Impressionist masterpieces is the largest in the world and includes well-known works by Monet, Manet, Degas, Renoir, Cézanne, Seurat, Sisley, Gauguin and Van Gogh. After touring the museum, you will be transferred to your hotel. Spend your second day in Paris exploring the multitude of landmarks, museums, cafes and shops that make up the French capital.



ARC DE TRIOMPHE

ENHANCED CRUISES AT NO ADDITIONAL COST



WINE CRUISES (see pages 34-39 for more information)

Add a unique, epicurean dimension to your itinerary.

Complimentary Bonus Features:

- ◆ Special tours and tastings of Champagne, Calvados and Benedictine
- ◆ Onboard wine pairings with award-winning cuisine
- ◆ A wine expert who leads tastings and discussions

Embark dates: 2018 - Mar 22, Mar 29, Jul 19, Aug 2, Nov 8

DATES AND FARES (£)

EMBARK DATE	START CITY	SHIP NAME	7-NIGHT CRUISE
Mar 22	Paris	Amalyra	£2,045
Mar 29	Paris	Amalyra	£2,111
Apr 5	Paris	Amalyra	£2,245
Apr 12	Paris	Amalyra	£2,311
Apr 26	Paris	Amalyra	£2,511
May 3	Paris	Amalyra	£2,511
May 10	Paris	Amalyra	£2,578
May 17	Paris	Amalyra	£2,578
May 24	Paris	Amalyra	£2,578
Jun 7	Paris	Amalyra	£2,578
Jun 14	Paris	Amalyra	£2,578
Jun 21	Paris	Amalyra	£2,578
Jun 28	Paris	Amalyra	£2,578
Jul 5	Paris	Amalyra	£2,511
Jul 19	Paris	Amalyra	£2,511
Aug 2	Paris	Amalyra	£2,511
Aug 9	Paris	Amalyra	£2,511
Aug 16	Paris	Amalyra	£2,578
Aug 30	Paris	Amalyra	£2,711
Sep 6	Paris	Amalyra	£2,711
Sep 13	Paris	Amalyra	£2,711
Sep 27	Paris	Amalyra	£2,711
Oct 4	Paris	Amalyra	£2,645
Oct 11	Paris	Amalyra	£2,578
Oct 18	Paris	Amalyra	£2,511
Oct 25	Paris	Amalyra	£2,378
Nov 1	Paris	Amalyra	£2,245
Nov 8	Paris	Amalyra	£2,178

■ Wine Cruise; visit www.amawaterways.co.uk for detailed itinerary.

Flights: Please call for fares and availability.

Transfers: Paris Airport (Charles De Gaulle) to Ship (or reverse): from £34 per person

Cruise fares are per person based on double occupancy in a Cat. E, deluxe outside stateroom with window. To upgrade to a higher category, add per person:

CAT.	DECK	STATEROOM	ADD'L
D	Piano	Window	£199
C	Violin & Cello	French Balcony	£599
B	Violin & Cello	French Balcony	£733
A	Violin	French Balcony	£799
A+	Violin	French Balcony	£1,466
Suite	Violin	French Balcony	£1,599

Port Charges: Fares include port charges of £112 per person

Single Supplement: Categories E – A: add 50% per person; Categories A+ and Suite: add 100% per person. Single supplement may be waived on D and E categories subject to availability. Please check at time of booking.

Bedding: Please select bedding configuration at the time of booking.

Option A: Two twin beds Option B: One large bed (larger than queen size)

Deck Plans: AMALYRA – See page 168

LAND PROGRAMMES

POST-CRUISE – 2 NIGHTS PARIS from £507 per person

Additional Hotel Nights (prices subject to change due to seasonality): Prices are per person. Double occupancy – £180, Single occupancy – £360

Additional hotel nights include portage, breakfast, as well as transfers to/from the ship only in cities where the ship is embarking or disembarking.

Single Supplement: 2 Nights Paris £213 per person

For more information on hotels, please see page 42.

THE SAÔNE & RHÔNE RIVERS



PROVENÇAL TOWN

COLOURS OF PROVENCE

7 NIGHTS • LYON TO ARLES (OR REVERSE)

AN ENCHANTING CRUISE FROM LYON EXPLORING THE BEAUTIFUL LOIRE VALLEY, ENDING IN THE HISTORIC TOWN OF ARLES



Cruise through France's legendary wine growing regions, home to such famous vintages as Beaujolais and Côtes du Rhône. Marvel at ancient Roman ruins, stroll through medieval villages and shop for Provencal crafts. After embarking in the beautiful city of Lyon, your itinerary includes the UNESCO World Heritage Site of Avignon as well as Arles, the city where Vincent Van Gogh spent much of his life. With a range of excursions choose between amazing culinary learning opportunities or delving into the history of this magical region of France.



LAVENDER FIELDS, PROVENCE



EXPLORE THE IMPRESSIVE CARRIÈRES DE LUMIÈRES

DAILY PROGRAMME FEATURES

DAY	DESTINATION	ACTIVITIES
1	Lyon, France	EMBARKATION
2	Lyon, France	City tour Free time OR Lyon bike tour
3	Collonges, France Vienne, France	Beaujolais excursion and tasting Free evening
4	Vienne	Walking tour OR ViaRhôna bike tour OR Mount Pipet hike
5	Tournon, France	Steam train ride OR Red wine and chocolate tasting OR Tain l'Hermitage hike and wine tasting
6	Avignon, France	Walking tour and Papal Palace OR Pont du Gard OR Provencal cooking lesson Grignan excursion and truffle farm visit OR Avignon bike tour
7	Arles, France	Les Baux and olive farm excursion OR Van Gogh Asylum and Carrières de Lumières OR Camargue and Aigues-Mortes Arles walking tour OR Van Gogh walking tour OR Arles bike tour
8	Arles	DISEMBARKATION

⚓ Embark 7-Night Cruise

⚓ Disembark 7-Night Cruise

Note: Bike tours and hikes subject to weather and seasonality.

For full itinerary details, visit www.amawaterways.co.uk

INCLUDED FEATURES

- » 7 nights deluxe cruise accommodation in riverview stateroom or suite – most staterooms offer French balconies
- » Entertainment-On-Demand in all staterooms featuring free high-speed internet access, movies, a music library and English language TV stations
- » Fine dining, including unlimited complimentary hand-selected wines, beer and soft drinks with lunch and dinner on board
- » Multiple dining venues, including The Chef's Table specialty restaurant featuring our unique tasting menu
- » **NEW FOR 2018 – Sip & Sail daily cocktail hour with complimentary wine, beer, spirits and soft drinks**
- » Welcome Cocktail, Welcome Dinner, La Chaîne des Rôtisseurs Dinner, Captain's Cocktail and Gala Dinner
- » Complimentary Wi-Fi access on board
- » Guided shore excursions in every port, including Special Interest Tours, hiking and biking tours
- » Onboard live entertainment, theme dinners, cooking demonstration and more
- » Complimentary bicycles, helmets and Nordic walking sticks
- » Services of a professionally trained Cruise Manager throughout your cruise and land stay
- » Transfers between hotel and ship are included with the purchase of cruise and land package

YOUR ITINERARY

Day 1, EMBARKATION – LYON, FRANCE. Nestled between the Saône and Rhône rivers, Lyon is one of France's most important cities and its gastronomic capital. Join your luxurious ship, where you will gather with your fellow travellers at tonight's festive Welcome Dinner. (D)

Day 2, LYON. Discover dynamic Lyon, starting in Fourvière Hill, part of the city's historic region that is now a designated UNESCO World Heritage Site and home to the 19th-century basilica Notre-Dame de Fourvière. Continue on to the old town of Lyon, followed by a guided walk through the St. Jean district, where you will be introduced to the city's unique covered walkways, known as "traboules." During the afternoon, enjoy leisure time or join a guided bike tour through the city designed with cyclists in mind. (B,L,D)

Day 3, COLLONGES – VIENNE. Travel to the Beaujolais wine region—known as the Pays d'Or or "land of the golden stones." Indulge in a wine tasting at a traditional winery and learn about the history and techniques of their vineyard. Later set sail for Vienne, where you'll enjoy free time to explore the town. (B,L,D)

Day 4, VIENNE – TOURNON. Situated between the wine regions of Beaujolais and Côtes du Rhône lies Vienne with a Roman past that can be seen in its marvelously preserved ruins. Take a walking tour to see the amazingly well-preserved Augustus and Livia Temple, the Saint Maurice Cathedral, a Gothic church that took more than 500 years to build, and St. Pierre Abbey—one of the oldest surviving churches in France, and now an Archaeological Museum. For those wishing to be more active, you can either take a guided bike tour along a portion of the ViaRhôna bike route or a guided hike from the ship to the Monastery at Mount Pipet. (B,L,D)

Day 5, TOURNON. Wine and chocolate lovers will enjoy visiting Tournon located in the heart of Côtes du Rhône. You have a choice of three excursions. Take a train ride past magnificent landscape carved along the Gorge du Doux stopping at the charming little station of Colombier le Vieux-Saint Barthélemy le Plain, where the train maneuvers in preparation for its return journey. Alternatively, lovers of wine and chocolate will want to visit Le Château de Tournon for a presentation and tasting on the pairing of red wine and chocolate. For a more active adventure, take a hike through the vineyards of Tain l'Hermitage, followed by a visit to a local winery where you'll sample some of the wines. (B,L,D)

Day 6, AVIGNON. Avignon, aptly named the "City of Popes," was the centre of the Catholic Church in the 14th century when its "Palais des Papes" was the equivalent of today's Vatican. Depending on your interests, you have three options of excursions. Discover the history of Avignon on a guided walking tour that includes the Papal Palace and the well-preserved medieval walls surrounding the historic centre of town, a UNESCO World Heritage Site. Alternatively, you can go to another UNESCO World Heritage Site, the impressive Pont du Gard, a Roman aqueduct that is a masterpiece of ancient engineering. Or if you prefer, learn the art of Provençal cooking by joining a local chef as he shares his insight with you, and afterwards, taste the fruits of your labour. During the afternoon, you can enjoy free time in Avignon; go on a bike tour; or go to the magnificent hilltop village, Grignan. After visiting this enchanting Provençal town, go in search of the highly prized "Black Diamond," truffles, with a farmer and his trustworthy canine companion. (B,L,D)

Day 7, AVIGNON – ARLES. Art lovers will wish to visit Saint Paul de Mausole Asylum, where Vincent van Gogh once lived and painted such well-known works as "The Irises" and "Starry Night." Afterwards, go to the Carrières de Lumières, where you'll be treated to a spectacular presentation of art, sound and history projected on the walls of caves. Alternatively, venture to the medieval hilltop village, Les Baux de Provence, followed by a visit to an olive farm where you'll get to taste the different olive oils. Or for a different adventure, journey to Aigues-Mortes, known for its well preserved medieval walls and guard towers, followed by a visit to the beautiful Camargue National Park, a protected natural territory with more than

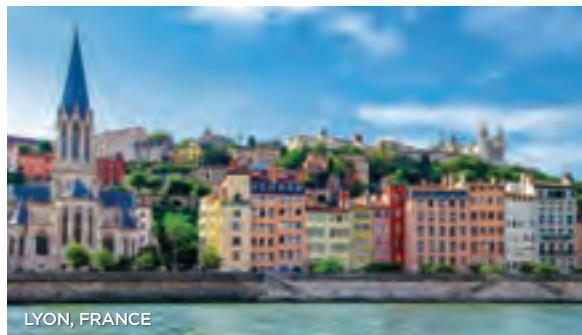

LYON, FRANCE

COLOURS OF PROVENCE

400 different species of birds. During the afternoon, join a walking tour of Arles highlighting top sights, including the Romanesque cathedral and Roman amphitheatre, or take a bike tour to the Roman ruins. And for those who wish to delve further into Van Gogh's Arles, join a special walking tour along with a visit to the Vincent van Gogh Foundation, showcasing his legacy. (B,L,D)

Day 8 DISEMBARKATION - ARLES. Disembark your ship in Arles and prepare for your journey home. (B)

SEE MORE OF FRANCE

Select departures may be combined with *Paris & Normandy* (page 50).

Ask for availability.

ENHANCED CRUISES AT NO ADDITIONAL COST



WINE CRUISES (see pages 34-39 for more information)
Add a unique, epicurean dimension to your itinerary.

Complimentary Bonus Features:

- ◆ Special tours and tastings at local wineries and private cellars
- ◆ Learn about winemaking in renowned vineyards
- ◆ Onboard wine pairings with award-winning cuisine
- ◆ A wine expert who leads tastings and discussions

Embark dates: 2018 - Mar 22, Apr 5, Nov 1, Nov 8

LAND PROGRAMME OPTIONS – PRE-CRUISE

PARIS - 2 NIGHTS

Upon arrival in Paris, check in to your hotel and explore the magical city at your own leisure. On the second day, you'll visit the famous Notre Dame cathedral and see some of the most famous sights on a panoramic city tour, followed by a photo stop at Champs de Mars for views of the Eiffel Tower. Your final day in Paris will give you the chance to explore the multitude of landmarks, museums, cafes and shops that make up the French capital. Check out of your hotel and board the TGV high-speed train that will whisk you through the French countryside to Lyon, where you will enjoy an exclusive hands on cooking lesson before boarding your ship.

LAND PROGRAMME OPTIONS – POST-CRUISE

BARCELONA - 3 NIGHTS

Continue your journey crossing the Pyrenees to transfer to Barcelona, Spain. Along the way, stop in the medieval French town of Perpignan. Your full day in Barcelona begins with a driving tour to the Gothic Quarter in the medieval centre of the city, before ascending Montjuic Hill where you will enjoy glorious views of the city below. See some of Barcelona's favourite son, Antoni Gaudi's unique architectural works, including Casa Milà, Casa Batlló and La Sagrada Familia, the basilica and UNESCO World Heritage Site that has been under construction for over a century. Spend your last day in Barcelona exploring this city, famous for its culture, sport and heritage, at your own leisure.

DATES AND FARES (£)

EMBARK DATE	START CITY	SHIP NAME	7-NIGHT CRUISE
Mar 22	Lyon	AmaCello	£2,045
Mar 29	Arles	AmaCello	£2,111
Apr 5	Lyon	AmaCello	£2,245
Apr 19	Lyon	AmaCello	£2,378
May 3	Lyon	AmaCello	£2,511
May 10	Arles	AmaCello	£2,578
May 31	Lyon	AmaCello	£2,578
Jun 14	Lyon	AmaCello	£2,578
Jun 28	Lyon	AmaCello	£2,578
Jul 26	Lyon	AmaCello	£2,511
Aug 2	Arles	AmaCello	£2,511
Aug 9	Lyon	AmaCello	£2,511
Aug 23	Lyon	AmaCello	£2,645
Sep 6	Lyon	AmaCello	£2,711
Sep 20	Lyon	AmaCello	£2,711
Oct 4	Lyon	AmaCello	£2,645
Oct 11	Arles	AmaCello	£2,578
Oct 18	Lyon	AmaCello	£2,511
Oct 25	Arles	AmaCello	£2,378
Nov 1	Lyon	AmaCello	£2,245
Nov 8	Arles	AmaCello	£2,178
Nov 15	Lyon	AmaCello	£2,178

■ Wine Cruise; visit www.amawaterways.co.uk for detailed itinerary.

Flights: Please call for fares and availability.

Transfers: Lyon Airport to Ship (or reverse): from £30 per person.
Ship (Arles) to Marseilles Airport (or reverse): from £87 per person.

Cruise fares are per person based on double occupancy in a Cat. E, deluxe outside stateroom with window. To upgrade to a higher category, add per person:

CAT.	DECK	STATEROOM	ADD'L
D	Piano	Window	£199
C	Violin & Cello	French Balcony	£599
B	Violin & Cello	French Balcony	£733
A	Violin	French Balcony	£799
Suite	Violin	French Balcony	£1,599

Port Charges: Fares include port charges of £112 per person

Single Supplement: Categories E - A: add 50% per person; Suite Category: add 100% per person. Single supplement may be waived on D and E categories subject to availability. Please check at time of booking.

Bedding: Please select bedding configuration at the time of booking.

Option A: Two twin beds

Option B: One large bed (larger than queen size)

Deck Plans: AMACELLO - See page 168

LAND PROGRAMMES

PRE-CRUISE - 3 NIGHTS PARIS from £880 per person

POST-CRUISE - 3 NIGHTS BARCELONA from £740 per person

Additional Hotel Nights (prices subject to change due to seasonality):

Prices are per person

Barcelona: Double occupancy - £160, Single occupancy - £320

Lyon: Double occupancy - £150, Single occupancy - £300

Paris: Double occupancy - £190, Single occupancy - £380

Additional hotel nights include portage, breakfast, as well as transfers to/from the ship only in cities where the ship is embarking or disembarking.

Single Supplement:

3 Nights Paris: £320 per person **3 Nights Barcelona:** £320 per person

For more information on hotels, please see page 42.

THE DOURO RIVER



PORTO, PORTUGAL

ENTICING DOURO

7 NIGHTS • PORTO ROUNDTRIP

CRUISE THROUGH THE DRAMATIC DOURO VALLEY, EXPERIENCING THE BEST OF PORTUGUESE CULTURE AND GASTRONOMY



The Douro River, with its dramatic gorges and lush vineyards sets the scene for this amazing cruise. Begin in Porto and continue to the ancient and picturesque city of Lamego. Enter Spain to visit Salamanca, a UNESCO World Heritage Site, before discovering Portugal's beautiful inland countryside and the palace and gardens of Mateus. You will have several opportunities to sample this renowned region's port wine before concluding your cruise in Porto.



PENA PALACE, SINTRA, PORTUGAL



SCENIC SAILING ALONG THE DOURO RIVER

DAILY PROGRAMME FEATURES

DAY	DESTINATION	ACTIVITIES
1	Porto, Portugal	EMBARKATION
2	Régua, Portugal	Lamego tour and Bólas tasting OR Lamego Steps hike and Bólas tasting Douro Museum
3	Barça d'Alva, Portugal	Castelo Rodrigo tour OR Castelo Rodrigo hike
4	Barça d'Alva Vega Terrón, Spain	Salamanca excursion OR Côa Valley Archaeological Park Flamenco show on board
5	Pinhão, Portugal	Quinta da Roêda lunch Quinta do Seixo Port wine tasting
6	Régua Entre-os-Rios, Portugal	Mateus Palace OR Quinta da Pacheca hike and picnic Dinner at Quinta de Aveleda
7	Porto	City tour and Graham's Winery with Port wine tasting OR Porto hike to Graham's Winery with Port wine tasting Tastes of Matosinhos tour OR Jewish Porto
8	Porto	DISEMBARKATION

⚓ Embark 7-Night Cruise

⚓ Disembark 7-Night Cruise

Note: Hikes subject to weather and seasonality.

For full itinerary details, visit www.amawaterways.co.uk

INCLUDED FEATURES

- » 7 nights deluxe cruise accommodation in riverview stateroom or suite - most staterooms and suites offer balconies
- » Complimentary internet access in all staterooms
- » Fine dining, including unlimited complimentary hand-selected wines, beer and soft drinks with lunch and dinner on board
- » **NEW FOR 2018 - Sip & Sail daily cocktail hour with complimentary wine, beer, spirits and soft drinks**
- » Welcome Cocktail, Welcome Dinner, La Chaîne des Rôtisseurs Dinner, Captain's Cocktail and Gala Dinner
- » Complimentary Wi-Fi access on board
- » Guided shore excursions in every port, including Special Interest Tours and hiking tours
- » Onboard live entertainment, theme dinners, cooking demonstration and more
- » Services of a professionally trained Cruise Manager throughout your cruise and land stay
- » Transfers between hotel and ship are included with the purchase of cruise and land package

YOUR ITINERARY

Day 1, EMBARKATION - PORTO, PORTUGAL. Embark your ship in Porto at the mouth of the Douro river. Gather onboard tonight for a welcome dinner. (D)

Day 2, PORTO - RÉGUA. Travel to picturesque Lamego, home to one of the most important pilgrimage sites in all of Portugal, where you'll go to the Nossa Senhora dos Remédios (Sanctuary of Our Lady of Remedies). The shrine features a staircase of nearly 700 steps, beautifully decorated with white and blue tiles, which the more active adventurer will want to hike. Concluding both tours, you will have the opportunity to sample local traditional specialties, such as Bólas de Lamego, bread filled with smoked ham; Presunto, a type of dry-cured ham; and Espumante, a Portuguese sparkling wine. You'll then go to the formal Episcopal Palace Museum. Later in the day, enjoy free time or visit the Douro Museum in Régua showcasing the history, culture and identity of the Douro Wine Region. (B,L,D)

Day 3, RÉGUA - BARCA D'ALVA. Spend time soaking up the beauty of the Douro River as you cruise to Barca d'Alva, where you will visit Castelo Rodrigo, a small fortified village perched high on a hilltop with centuries-old walls, steep narrow streets and fantastic views. You can also opt to hike up to the village should you wish a more active exploration. While here, taste

some delicious locally grown produce. Back on board the ship, enjoy a traditional flamenco show. (B,L,D)

Day 4, SALAMANCA - VEGA TERRÓN. Drive to Salamanca, a UNESCO World Heritage Site. Built of golden sandstone, Salamanca is known as a "living museum," and you will have an opportunity to step back in time to the Middle Ages during your guided tour, which includes the city's elegant university buildings, the twin-towered Cathedral, the intriguingly decorated House of Shells and Plaza Mayor. For a different adventure, visit the Côa Valley Archaeological Park, a UNESCO World Heritage Site, considered the world's most important Paleolithic open-air rock art site. (B,L,D)

Day 5, VEGA TERRÓN - PINHÃO.

Be treated to an exclusive lunch at Quinta da Roêda, Croft's flagship vineyard estate. Discover the secrets of the vineyards as you take a guided walking tour through the property, stopping at points of interest along the way and taking in the magnificent landscape and the stunning views across the Douro River. Later in the day, venture to Quinta do Seixo, producers of some of the most traditionally made wine in the Douro region. An expert from the Sandeman Winery will take you on a tasting and private tour of the wine cellars, teaching you about the centuries-old winemaking methods. (B,L,D)



WINE CELLAR VISIT

ENTICING DOURO

Day 6, RÉGUA - ENTRE-OS-RIOS. Cruise to Régua where you can visit the Baroque-style Palacio de Mateus and its gardens, located in the beautiful Trás-os-Montes region. Inside the house you'll see exhibits of religious images and beautiful furnishings, paintings and a ceiling of intricately carved wood. The gardens here are considered some of the most beautiful in Portugal. Alternatively, you may wish to hike to Quinta da Pacheca where you will enjoy breathtaking views over the Douro River along with a picnic in a terraced vineyard. During the evening, be treated to a special dinner at Quinta de Aveleda, one of the best wine producing estates in the Vinho Verde region. While here, wander through the Quinta Aveleda's gardens, where you'll find a thatched house for geese, peacocks and graceful swans. (B,L,D)

Day 7, PORTO. The colourful city of Porto blends the best of old and new, which you can discover on a guided tour of the historic quarter, a UNESCO World Heritage Site, including the Cathedral, one of the city's oldest monuments; and the São Bento Railway Station, known for its blue and white tile panels depicting scenes from Portuguese history. You'll also enjoy a tasting of Port, Portugal's most renowned contribution to the world of wine at Graham's Winery. Prefer to get more active, you can hike to Graham's Winery, offering magnificent views over the Douro River. Later in the day, take a short journey to a nearby coastal town for the "Tastes of Matosinhos" tour where you'll visit a traditional restaurant serving Pataniscas, a traditional Portuguese cod fish cake, and other typical regional snacks. You also have the option to go on the Jewish Porto tour through the

Jewish Quarter of the city discovering the fascinating Jewish heritage. (B,L,D)

Day 8, DISEMBARKATION - PORTO. Disembark the ship and you prepare for your flight home. (B)

LAND PROGRAMME OPTIONS - PRE-CRUISE

LISBON - 3 NIGHTS

Arrive in Lisbon and head out to explore one of Europe's most beautiful cities, sprawling along the Tagus River. See Belem Tower, a fortified 4-story tower made of limestone, and visit the Late Gothic Jerónimos Monastery, the burial place of many Portuguese kings and heroes. You will encounter the Discoveries Monument, built in honour of Portugal's greatest maritime explorers. Take in sights such as the Castle of São Jorge or the Santa Justa Elevator that overlooks the castle, river and Rossio Square. A full morning excursion to Serra de Sintra encompasses one of the loveliest mountain villages in Portugal and a favourite summer residence of the Portuguese royal family for more than 500 years. Lord Byron once called it "perhaps the most delightful village in Europe." High up on a rocky peak, you will also discover the Castelo da Pena, a wonderful fairy tale castle dating from Portugal's Romantic period. Then an optional wine tasting of some delightful Portuguese wines is on offer before departing Lisbon by high speed train.

ENHANCED CRUISES AT NO ADDITIONAL COST



WINE CRUISES (see pages 34-39 for more information)
Add a unique, epicurean dimension to your itinerary.

Complimentary Bonus Features:

- ◆ Special tours and tastings at local wineries and private cellars
- ◆ Learn about winemaking in renowned vineyards
- ◆ Onboard wine pairings with award-winning cuisine
- ◆ A wine expert who leads tastings and discussions

Embark dates: 2018 - Jul 10, Aug 7, Aug 14, Nov 6, Nov 13

DATES AND FARES (£)

EMBARK DATE	START CITY	SHIP NAME	7-NIGHT CRUISE
Apr 17	Porto	AmaVida	£2,178
Apr 24	Porto	AmaVida	£2,245
Jun 12	Porto	AmaVida	£2,511
Jun 19	Porto	AmaVida	£2,511
Jul 10	Porto	AmaVida	£2,445
Jul 17	Porto	AmaVida	£2,445
Aug 7	Porto	AmaVida	£2,445
Aug 14	Porto	AmaVida	£2,445
Sep 4	Porto	AmaVida	£2,645
Sep 11	Porto	AmaVida	£2,645
Oct 2	Porto	AmaVida	£2,645
Oct 9	Porto	AmaVida	£2,578
Oct 30	Porto	AmaVida	£2,378
Nov 6	Porto	AmaVida	£2,311
Nov 13	Porto	AmaVida	£2,178

■ Wine Cruise; visit www.amawaterways.co.uk for detailed itinerary.

Flights: Please call for fares and availability.

Transfers: Porto Airport to Ship (or reverse): from £20 per person.

Cruise fares are per person based on double occupancy in a Cat. E, deluxe outside stateroom with window. To upgrade to a higher category, add per person:

CAT.	DECK	STATEROOM	ADD'L
D	Douro	Window	£199
C	Lisbon	Balcony	£799
B	Lisbon	Balcony	£933
A	Porto	Balcony	£1,133
Suite	Porto	Balcony	£2,133

Port Charges: Fares include port charges of £112 per person

Single Supplement: Categories E - A: add 50% per person; Suite Category: add 100% per person. Single supplement may be waived on D and E categories subject to availability. Please check at time of booking.

Single Supplement Cruise: 50% of twin price; Suites 100% of twin price. Single supplement waived on D and E categories. Please check at time of booking as offer is capacity controlled.

Bedding: Please select bedding configuration at the time of booking.
Option A: Two twin beds
Option B: One large bed (larger than queen size)

Deck Plans: AMAVIDA - See page 170

LAND PROGRAMMES

PRE-CRUISE - 3 NIGHTS LISBON from £520 per person

Additional Hotel Nights (prices subject to change due to seasonality):

Prices are per person

Lisbon: Double occupancy - £100, Single occupancy - £200

Porto: Double occupancy - £134, Single occupancy - £267

Upgrade to the Four Seasons in Lisbon is available; ask for details.

Additional hotel nights include portage, breakfast, as well as transfers to/from the ship only in cities where the ship is embarking or disembarking.

Single Supplement: 3 Nights Lisbon £320 per person

For more information on hotels, please see page 42.

THE HEART OF EUROPE

Explore the many sights and wonders along the Danube, Rhine, Main and Moselle rivers.

The Danube

Captured in literature, art and Strauss's famous "Blue Danube" waltz, this river is one of the world's most romantic waterways. Extending for thousands of miles through Central Europe, the Danube flows eastward, passing four capital cities before emptying into the Black Sea.

The Rhine, Main and Moselle

The Rhine rises in the Swiss Alps and flows into Germany, where it joins the Moselle and its major tributary, the Main. Along these rivers are captivating sights that include castles, stunning vineyards and verdant valleys.

Dutch and Belgian Waterways

A series of connecting rivers, including the Amstel, from which Amsterdam took its name, connect the Netherlands and Belgium. A voyage along these waterways in the spring offers many opportunities to watch nature blossom in breathtaking fashion in this picturesque part of the world.



THE DUTCH & BELGIAN WATERWAYS



TULIP FIELDS IN THE NETHERLANDS

TULIP TIME

7 NIGHTS • AMSTERDAM ROUNDTRIP

SAIL FROM THE DUTCH CAPITAL OF AMSTERDAM AND EXPERIENCE THE BULBFIELDS OF THE NETHERLANDS AND BELGIUM IN THE SPRING



Celebrate spring in the Netherlands and Belgium when the Keukenhof Gardens and Floralia come alive. Experience Amsterdam's colourful canals, the whimsical Kinderdijk windmills and the art of Rubens and Michelangelo. Discover the timeless traditions of Delft porcelain and revel in the medieval architectural treasures of Bruges, Middelburg and Ghent. Throughout your journey indulge in Belgian chocolates, warm waffles and delicious cheeses—all while savouring the storybook atmosphere of the region.



DUTCH WINDMILL



BELGIAN CHOCOLATE WORKSHOP

DAILY PROGRAMME FEATURES

DAY	DESTINATION	ACTIVITIES
1	Amsterdam, The Netherlands	🚢 EMBARKATION
2	Amsterdam, Hoorn, The Netherlands	The IJsselmeer scenic cruising Tulips and bulb fields OR Hoorn walking tour and Dutch East India replica ship visit OR Dutch countryside bike tour
3	Delta, The Netherlands Middelburg, The Netherlands	Scenic cruising Middelburg walking tour OR Delta Works visit OR Middelburg bike ride
4	Antwerp, Belgium	Walking tour and Cathedral visit OR Rubens House OR Antwerp bike tour Belgian chocolate, beer and waffle tasting OR Floralia Flower Show
5	Ghent, Belgium	Ghent walking tour OR Belgian chocolate workshop OR Full-day Bruges and Church of Our Lady with Michelangelo statue OR Highlights of Ghent and Bruges
6	Rotterdam, The Netherlands Schoonhoven, The Netherlands	Gouda and The Hague OR Gouda and Royal Delft Porcelain OR Rotterdam's architectural bike tour Kinderdijk UNESCO Windmills Free time
7	Amsterdam	Keukenhof Gardens excursion Amsterdam canal cruise
8	Amsterdam	🚢 DISEMBARKATION

🚢 Embark 7-Night Cruise

🚢 Disembark 7-Night Cruise

Note: Bike tours subject to weather and seasonality.

For full itinerary details, visit www.amawaterways.co.uk

INCLUDED FEATURES

- » 7 nights deluxe cruise accommodation in riverview stateroom or suite - most staterooms offer twin balconies or French balconies
- » Entertainment-On-Demand in all staterooms featuring free high-speed internet access, movies, a music library and English language TV stations
- » Fine dining, including unlimited complimentary hand-selected wines, beer and soft drinks with lunch and dinner on board
- » Multiple dining venues, including The Chef's Table specialty restaurant featuring our unique tasting menu
- » **NEW FOR 2018 - Sip & Sail daily cocktail hour with complimentary wine, beer, spirits and soft drinks**
- » Welcome Cocktail, Welcome Dinner, La Chaîne des Rôtisseurs Dinner, Captain's Cocktail and Gala Dinner
- » Complimentary Wi-Fi access on board
- » Guided shore excursions in every port, including Special Interest Tours and biking tours
- » Onboard live entertainment, theme dinners, cooking demonstration and more
- » Complimentary bicycles, helmets and Nordic walking sticks
- » Services of a professionally trained Cruise Manager throughout your cruise and land stay
- » Transfers between hotel and ship are included with the purchase of cruise and land package

YOUR ITINERARY

Day 1, EMBARKATION - AMSTERDAM, THE NETHERLANDS. Welcome to Amsterdam, a modern city with a rich and fascinating 700-year old history. Explore its unique and elegant architecture, lively cafés and markets, and vibrant nightlife. This evening, meet your fellow travellers on board at the Welcome Dinner. (D).

Day 2, AMSTERDAM - HOORN. Enjoy a scenic cruise through the IJsselmeer to Hoorn, where you have a choice of three excursions. Visit a family-run tulip farm with over one million tulips, each in different phases of growth and in many species and colours. For those seeking to travel back in time, you can tour De Halve Maen, a replica of the Dutch East India Company's most famous ship and then stroll through Hoorn's beautiful old harbour. And for more active adventurers, go for a guided bike ride through the Dutch countryside. (B,L,D)

Day 3, MIDDELBURG. After enjoying a scenic cruise through the Delta, you can explore medieval Middelburg, which was the second largest trading city of the Dutch East India Company. Or, if you feel like exploring the city

on two wheels, a guided bike ride is the perfect choice. Alternatively, you may venture off to the Delta Works storm surge barrier, an impressive series of dams and Dutch hydraulic engineering. More than half of the Netherlands lies below sea level and the Delta Works were built to prevent a recurrence of the 1953 flood disaster. (B,L,D)

Day 4, ANTWERP. Explore this trendy city on a walking tour where you'll see Antwerp's Steen Castle, Grote Market and Brabo Fountain, along with the UNESCO-designated Cathedral of Our Lady. For a more active exploration of the area, join a guided bike tour. Or you can visit the Rubens House, the former home of the famous 17th-century Flemish Baroque painter. Later in the afternoon, you have a choice of two excursions. Foodies will want to go on a culinary tour to indulge in chocolate, waffles and beer. Flower lovers and gardeners can roam through the Floralia, an annual spring flower show featuring approximately one million bulbs that are hand-planted each year by the castle staff. (B,L,D)



KEUKENHOF GARDENS, AMSTERDAM

TULIP TIME

Day 5, GHENT. Discover medieval Ghent on a walking tour. Admire the canal-side architecture and some of its famous sights, including the Castle of the Counts and Ghent Cathedral. Those more inclined to learn about the art of Belgian chocolate making can join a master chocolatier as he shares his insights. Alternatively, you may also visit one of the best preserved medieval cities in Europe, Bruges, on a full-day excursion that includes a visit to the Church of Our Lady, home to the beautiful Carrara marble Madonna and Child sculpture by Michelangelo. And for those who wish to see both Ghent and Bruges, join a highlights tour showcasing them both. (B,L,D)

Day 6, ROTTERDAM – KINDERDIJK – SCHOONHOVEN. During the morning, you can visit The Hague, the capital city of the province of South Holland, before going to the charming city of Gouda, known for its delicious cheese. Alternatively, combine Gouda with a visit to the Royal Delft Porcelain Factory and Museum, known for being the manufacturing base for hand-painted blue pottery known



HISTORIC CENTER OF GHENT, BELGIUM

as Delftware. Or enjoy a guided bike tour through scenic Rotterdam, nicknamed the "Gateway to Europe." In the afternoon, venture to the UNESCO World Heritage Site of Kinderdijk, a lovely village renowned for having the country's greatest concentration of windmills, all dating from the 18th century. (B,L,D)

Day 7, AMSTERDAM. One of the most impressive public gardens in the world, Keukenhof, presents a spectacular display of millions of flowering tulips spread out over 70 acres. Spend time ambling through this legendary garden, open only nine weeks a year and sometimes referred to as the "Garden of Europe." Later in the day, admire Amsterdam's historic harbor and canals, where you'll see beautiful homes lining the water, the fabled Skinny Bridge and the Anne Frank House. (B,L,D)

Day 8, DISEMBARKATION – AMSTERDAM. Disembark the ship and prepare for your flight home. (B)

LAND PROGRAMME OPTIONS – PRE-CRUISE

AMSTERDAM – 2 NIGHTS

One of the world's most scenic cities and the country's capital, Amsterdam is the largest city in the Netherlands. From your arrival you will head to your hotel and enjoy an evening at leisure with the chance to walk the canals and paths of one of Europe's most important port cities. The next day you will explore the history of this famous city in depth with an immersive city tour visiting locations such as the world's oldest stock exchange, the Rijksmuseum and Anne Frank's House. Before embarking the ship on your third day in the city you will also get the chance to discover further afield with a trip to the picturesque windmills at Zaanse Schans.

DATES AND FARES (£)

EMBARK DATE	START CITY	SHIP NAME	7-NIGHT CRUISE
Mar 25	Amsterdam	AmaLea	£1,778
Mar 26	Amsterdam	AmaKristina	£1,778
Apr 01	Amsterdam	AmaLea	£1,911
Apr 02	Amsterdam	AmaKristina	£1,911
Apr 07	Amsterdam	AmaPrima	£1,978
Apr 08	Amsterdam	AmaLea	£1,978
Apr 09	Amsterdam	AmaKristina	£1,978
Apr 14	Amsterdam	AmaPrima	£2,045
Apr 15	Amsterdam	AmaLea	£2,111
Apr 16	Amsterdam	AmaKristina	£2,111
Apr 21	Amsterdam	AmaPrima	£2,178
Apr 22	Amsterdam	AmaLea	£2,178
Apr 23	Amsterdam	AmaKristina	£2,178
Apr 28	Amsterdam	AmaPrima	£2,245
Apr 29	Amsterdam	AmaLea	£2,245

Flights: Please call for fares and availability.

Transfers: Amsterdam Airport to Ship (or reverse): from £20 per person.

Cruise fares are per person based on double occupancy in a Cat. E, deluxe outside stateroom with window. To upgrade to a higher category, add per person:

CAT.	DECK	STATEROOM	ADD'L
D	Piano	Window	£199
CB	Violin	French Balcony	£399
CA/C	Violin & Cello	French Balcony	£599
BB	Cello	French/Outside Balcony	£933
BA	Violin	French/Outside Balcony	£1,066
AB	Cello	French/Outside Balcony	£1,199
AA	Violin	French/Outside Balcony	£1,333
AA+	Violin	French/Outside Balcony	£1,773
Suite	Violin	French/Outside Balcony	£2,199

Port Charges: Fares include port charges of £112 per person

Single Supplement: Categories E – AA: add 50% per person; Categories AA+ and Suite: add 100% per person. Single supplement may be waived on D and E categories subject to availability. Please check at time of booking.

Bedding: Please select bedding configuration at the time of booking.

Option A: Two twin beds

Option B: One large bed (larger than queen size)

Deck Plans: AMALEA & AMAKRISTINA – See page 164

AMAPRIMA – See page 166

LAND PROGRAMMES

PRE-CRUISE – 2 NIGHTS AMSTERDAM from £427 per person

Additional Hotel Nights (prices subject to change due to seasonality):

Prices are per person

Amsterdam: Double occupancy – £150, Single occupancy – £294

Additional hotel nights include portage, breakfast, as well as transfers to/from the ship only in cities where the ship is embarking or disembarking.

Single Supplement: 2 Nights Amsterdam £213 per person

For more information on hotels, please see page 42.

THE DANUBE RIVER



THE BUDAPEST PARLIAMENT BUILDING ON THE DANUBE

ROMANTIC DANUBE

7 NIGHTS • VILSHOFEN TO BUDAPEST

ENJOY A CLASSIC DANUBE CRUISE, COVERING THREE LEGENDARY EUROPEAN CAPITALS INCLUDING BUDAPEST



Those longing for the romance of Old World Europe can travel into the very heart of the continent, where empires were built, kings and queens were crowned and some of the world's greatest music was composed. Vienna, Bratislava and Budapest forever remain timeless. The hills are alive with beauty in Salzburg and in the charming mountain town, Český Krumlov. From plentiful UNESCO World Heritage Sites to breathtaking scenery, be romanced by the Danube.



DAILY PROGRAMME FEATURES

DAY	DESTINATION	ACTIVITIES
1	Vilshofen, Germany	✳️ EMBARKATION Exclusive Oktoberfest
2	Vilshofen, Passau, Germany	Free time Walking tour OR Passau Castle hike
3	Linz, Austria	Walking tour OR Full-day Salzburg OR Castle and "Culture Mile" bike tour Half-day Salzburg OR Český Krumlov OR Austrian Lake District
4	Weissenkirchen, Austria	Dürnstein walking tour and Melk Benedictine Abbey OR Dürnstein Fortress hike OR Apricots and Sweets tasting Evening wine tasting at local winery
5	Vienna, Austria	City tour OR Alte Donau bike tour Free time OR Klosterneuburg Monastery bike tour
6	Bratislava, Slovakia	Walking tour OR Slovakian specialties tasting OR Bratislava Castle hike
7	Budapest, Hungary	City tour OR Castle Hill hike Illuminations cruise
8	Budapest	⚓ DISEMBARKATION

✳️ Embark 7-Night Cruise

⚓ Disembark 7-Night Cruise

Note: Cruises in Oct/Nov will not visit Bratislava. Bike tours and hikes subject to weather and seasonality.

For full itinerary details, visit www.amawaterways.co.uk

INCLUDED FEATURES

- » 7 nights deluxe cruise accommodation in riverview stateroom or suite – most staterooms and suites offer twin balconies
- » Entertainment-On-Demand in all staterooms featuring free high-speed internet access, movies, a music library and English language TV stations
- » Fine dining, including unlimited complimentary hand-selected wines, beer and soft drinks with lunch and dinner on board
- » Multiple dining venues, including The Chef's Table specialty restaurant featuring our unique tasting menu
- » **NEW FOR 2018 – Sip & Sail daily cocktail hour with complimentary wine, beer, spirits and soft drinks**
- » Welcome Cocktail, Welcome Dinner, La Chaîne des Rôtisseurs Dinner, Captain's Cocktail and Gala Dinner
- » Complimentary Wi-Fi access on board
- » Guided shore excursions in every port, including Special Interest Tours, hiking and biking tours
- » Onboard live entertainment, theme dinners, cooking demonstration and more
- » Complimentary bicycles, helmets and Nordic walking sticks
- » Services of a professionally trained Cruise Manager throughout your cruise and land stay
- » Transfers between hotel and ship are included with the purchase of cruise and land package

YOUR ITINERARY

Day 1, EMBARKATION – VILSHOFEN, GERMANY. Arrive at the charming 1,200-year-old Bavarian town of Vilshofen and board your luxurious ship. Later this afternoon, join your fellow passengers at a private Oktoberfest celebration in Vilshofen, with traditional beers and Bavarian folk music and dancing. Later, enjoy a festive Welcome Dinner aboard the ship. (D)

Day 2, VILSHOFEN – PASSAU. Explore Vilshofen's beautiful old town before cruising to Passau, known as the "City of Three Rivers." Join a walking tour or if you prefer to be more active, hike high into the hills for a visit to the "Veste Oberhaus," Passau's Castle Hill. (B,L,D)

Day 3, LINZ. The ship arrives in Linz where you'll have several choices of excursions. Opt for a full-day excursion to Salzburg where you'll tour the historic centre, Mirabell Gardens, Residenz Square and the Old Market. En route to Salzburg, stop at Mondsee, home of the famed Basilica St. Michael and site of the wedding scene in "The Sound of Music." Alternatively, you can join a morning walking tour through Linz's old city centre and by the Mozart House; or go on a guided bike tour along the city's famed "Culture Mile" and the Danube. During the afternoon, you have three more options of excursions. Choose a half-day in Salzburg or take a scenic drive through the beautiful Austrian Lake District with a stop in St. Wolfgang. You can also choose to visit the charming mountain town,

Český Krumlov, located just over the Czech-Austrian border. (B,L,D)

Day 4, WEISSENKIRCHEN. Cruise to Weissenkirchen, gateway to Dürnstein located in the heart of the Wachau Valley. Once here, you can choose to join a walking tour in Dürnstein along its cobblestone streets to the Baroque Stiftskirche, Dürnstein's famed church tower, and then visit Melk's magnificent Benedictine Abbey. For the more active adventurer, hike up to the fortress where Richard the Lionheart was once held. As an alternative excursion, visit a local apricot grower, where you'll enjoy the regions finest apricot treats. Later in the evening, enjoy a special wine tasting of locally grown, world-renowned Riesling and Grüner Veltliner in Weissenkirchen. (B,L,D)

Day 5, VIENNA. The "City of Waltzes" offers a treasure trove of gems and you have three ways to discover them. Join a city tour showcasing its regal splendours, including the majestic Opera House, St. Stephen's Cathedral and the former Imperial Palace of the Habsburgs before concluding in Vienna's historic city centre, a UNESCO World Heritage Site. For a more active exploration of the area, take a guided bike ride along the Danube. During the afternoon, you can enjoy leisure time or pedal your way to Klosterneuburg Monastery on a guided cycling tour. (B,L,D)



VILSHOFEN, GERMANY

ROMANTIC DANUBE

Day 6, BRATISLAVA. Host to the crowning ceremonies of 11 Hungarian kings and queens between 1536 and 1830, Bratislava certainly has earned the title “Coronation City of Kings” as you’ll discover during your walking tour. Or join a culinary host to sample traditional Slovakian specialties, as well as learn how to prepare stuffed potato ravioli with an opportunity to taste your own creation. For a more active adventure, hike up to Bratislava Castle, offering magnificent views of the city. (B,L,D)

Day 7 BUDAPEST. Experience Budapest in one of two ways: on a city tour or a hike. Your city tour begins with a visit to the vibrant Great Market Hall brimming with vendors selling everything from food to souvenirs. The remainder of this tour takes you to both the Buda (hilly) and Pest (flat) sides of the river. As an alternative choice, hike up to Castle Hill for breathtaking views of the city below. Spend your last evening on board cruising around the famed Parliament Building as the city turns on all her dazzling lights. (B,L,D)

Day 8, DISEMBARKATION – BUDAPEST. Disembark the ship as you prepare for your flight home. (B)

ENHANCED CRUISES AT NO ADDITIONAL COST



WINE CRUISES (see pages 34-39 for more information)
Add a unique, epicurean dimension to your itinerary.

Complimentary Bonus Features:

- ◆ Special tours and tastings at local wineries and private cellars
- ◆ Learn about winemaking in renowned vineyards
- ◆ Onboard wine pairings with award-winning cuisine
- ◆ A wine expert who leads tastings and discussions

Embark dates: 2018 - Mar 23, Nov 2, Nov 9, Nov 11

DATES AND FARES (£)

EMBARK DATE	START CITY	SHIP NAME	7-NIGHT CRUISE
Mar 23	Vilshofen	AmaSerena	£1,778
Mar 24	Vilshofen	AmaCerto	£1,778
Mar 30	Vilshofen	AmaViola	£1,845
Apr 06	Vilshofen	AmaSerena	£1,978
Apr 13	Vilshofen	AmaViola	£2,045
Apr 20	Vilshofen	AmaSerena	£2,111
Apr 27	Vilshofen	AmaViola	£2,245
May 04	Vilshofen	AmaSerena	£2,311
May 11	Vilshofen	AmaViola	£2,378
May 18	Vilshofen	AmaSerena	£2,378
May 25	Vilshofen	AmaViola	£2,378
May 27	Vilshofen	AmaLea	£2,378
Jun 01	Vilshofen	AmaSerena	£2,378
Jun 08	Vilshofen	AmaViola	£2,378
Jun 10	Vilshofen	AmaLea	£2,378
Jun 15	Vilshofen	AmaSerena	£2,378
Jun 22	Vilshofen	AmaViola	£2,378
Jun 24	Vilshofen	AmaLea	£2,378
Jun 29	Vilshofen	AmaSerena	£2,378
Jul 06	Vilshofen	AmaViola	£2,311
Jul 08	Vilshofen	AmaLea	£2,311
Jul 13	Vilshofen	AmaSerena	£2,311
Jul 20	Vilshofen	AmaViola	£2,311
Jul 22	Vilshofen	AmaLea	£2,311
Jul 27	Vilshofen	AmaSerena	£2,311
Aug 03	Vilshofen	AmaViola	£2,311
Aug 05	Vilshofen	AmaLea	£2,311
Aug 10	Vilshofen	AmaSerena	£2,311
Aug 17	Vilshofen	AmaViola	£2,378
Aug 19	Vilshofen	AmaLea	£2,378
Aug 24	Vilshofen	AmaSerena	£2,445
Aug 31	Vilshofen	AmaViola	£2,511
Sep 02	Vilshofen	AmaLea	£2,511
Sep 07	Vilshofen	AmaSerena	£2,511
Sep 14	Vilshofen	AmaViola	£2,511
Sep 16	Vilshofen	AmaLea	£2,511
Sep 21	Vilshofen	AmaSerena	£2,511
Sep 28	Vilshofen	AmaViola	£2,511
Sep 30	Vilshofen	AmaLea	£2,511
Oct 05	Vilshofen	AmaSerena	£2,511
Oct 12	Vilshofen	AmaViola	£2,378
Oct 14	Vilshofen	AmaLea	£2,378
Oct 19	Vilshofen	AmaSerena	£2,311
Oct 26	Vilshofen	AmaViola	£2,178
Oct 28	Vilshofen	AmaLea	£2,178
Nov 02	Vilshofen	AmaSerena	£2,111
Nov 09	Vilshofen	AmaViola	£2,045
Nov 11	Vilshofen	AmaLea	£1,978
Dec 23	Vilshofen	AmaLea	£2,045

■ Wine Cruise; visit www.amawaterways.co.uk for detailed itinerary.

Flights: Please call for fares and availability.

Transfers: Munich Airport to Ship (Vilshofen): from £20 per person.

Ship to Budapest Airport: from £20 per person.

OTHER ITINERARY OPTIONS

3 nights in Munich at the luxurious Hotel Bayerischer Hof and 7-night cruise

From an additional **£880** per person (added to the 7-night cruise price). Single Supplement £320 per person.

For more information, visit www.amawaterways.co.uk

Cruise fares are per person based on double occupancy in a Cat. E, deluxe outside stateroom with window. To upgrade to a higher category, add per person:

CAT.	DECK	STATEROOM	ADD'L
D	Piano	Window	£199
CB	Violin	French Balcony	£399
CA/C	Violin & Cello	French Balcony	£599
BB	Cello	French/Outside Balcony	£933
BA	Violin	French/Outside Balcony	£1,066
AB	Cello	French/Outside Balcony	£1,199
AA	Violin	French/Outside Balcony	£1,333
AA+	Violin	French/Outside Balcony	£1,733
Suite	Violin	French/Outside Balcony	£2,199

Port Charges: Fares include port charges of £112 per person

Single Supplement: Categories E – AA: add 50% per person; Categories AA+ and Suite: add 100% per person. Single supplement may be waived on D and E categories subject to availability. Please check at time of booking.

Bedding: Please select bedding configuration at the time of booking.

Option A: Two twin beds

Option B: One large bed (larger than queen size)

Deck Plans: AMALEA & AMAVIOLA – See page 164

AMACERTO & AMASERENA – See pages 166

LAND PROGRAMMES

PRE CRUISE – 3 NIGHTS PRAGUE from £520 per person

Additional Hotel Nights (prices subject to change due to seasonality):

Prices are per person

Prague: Double occupancy – £94, Single occupancy – £187

Budapest: Double occupancy – £100, Single occupancy – £200

Upgrade to the Four Seasons in Prague is available; ask for details.

Additional hotel nights include portage, breakfast, as well as transfers to/from the ship only in cities where the ship is embarking or disembarking.

Single Supplement: 3 Nights Prague £320 per person

For more information on hotels, please see page 42.

LAND PROGRAMME OPTIONS – PRE-CRUISE

PRAGUE – 3 NIGHTS

From your arrival in Prague you will be free to start exploring this beautiful city. With choices between a standard city tour and a hike, excursions will reveal why Prague is considered one of Europe’s most attractive cities. Its historic city centre is recognised as a UNESCO World Heritage Site. Visit the 1,000 year-old Prague Castle and St. Vitus before walking over the romantic Charles Bridge to the Old Market Square, where you will find the capital’s famous Astronomical Clock. Spend time exploring the city yourself, possibly taking in a museum or gallery, wandering along the banks of the Vltava River, or shopping for local handicrafts. Your journey will include a guided walking tour of Regensburg, one of Germany’s best preserved medieval cities and a UNESCO World Heritage Site.

THE DANUBE RIVER



MELODIES OF THE DANUBE

7 NIGHTS • BUDAPEST TO VILSHOFEN

EXPERIENCE THE DANUBE, EUROPE'S MOST ROMANTIC WATERWAY, SAILING NORTH THROUGH 4 COUNTRIES



Journey along the Danube and see first-hand why this storied river has inspired generations of artists, poets and musicians. Indulge your passion for timeless architecture and art in three magnificent capitals: Budapest, Bratislava and Vienna. Let the hills come alive with the sounds of music in Salzburg and the Austrian Lake District. Cruise through the enchanting Strudengau Valley and let the melodies of the Danube carry you from one gem to another on a regal journey through time.



STATUE OF JOHANN STRAUSS, VIENNA



FAVOURITE REGIONAL FLAVORS, GERMANY

DAILY PROGRAMME FEATURES

DAY	DESTINATION	ACTIVITIES
1	Budapest, Hungary	✳️ EMBARKATION Illuminations cruise
2	Budapest	City tour; Free time
3	Bratislava, Slovakia	Walking tour OR Castle hike OR Slovakian specialties tasting
4	Vienna, Austria	City tour OR Alte Donau bike tour Klosterneuburg bike tour OR Free time
5	Weissenkirchen, Austria	Highlights of Dürnstein and Melk Abbey OR Weissenkirchen to Melk bike tour OR Weissenkirchen walking tour and Melk Abbey OR Dürnstein excursion with wine and apricots tastings
	Ybbs, Austria	Scenic cruising of Strudengau Valley
	Grein, Austria	Exclusive castle visit with folklore show and sparkling wine reception
6	Linz, Austria	Walking tour OR Full-day Salzburg OR Castle and "Culture Mile" bike tour Half-day Salzburg OR Český Krumlov OR Austrian Lake District
7	Passau, Germany	Walking tour OR Passau bike tour OR Passau Castle hike
	Vilshofen, Germany	Exclusive Oktoberfest
8	Vilshofen	⚓ DISEMBARKATION

✳️ Embark 7-Night Cruise

⚓ Disembark 7-Night Cruise

Note: Cruises in Nov/Dec will not visit Bratislava.

Bike tours and hikes subject to weather and seasonality.

For full itinerary details, visit www.amawaterways.co.uk

INCLUDED FEATURES

- » 7 nights deluxe cruise accommodation in riverview stateroom or suite - most staterooms offer twin balconies
- » Entertainment-On-Demand in all staterooms featuring free high-speed internet access, movies, a music library and English language TV stations
- » Fine dining, including unlimited complimentary hand-selected wines, beer and soft drinks with lunch and dinner on board
- » Multiple dining venues, including The Chef's Table specialty restaurant featuring our unique tasting menu
- » **NEW FOR 2018 - Sip & Sail daily cocktail hour with complimentary wine, beer, spirits and soft drinks**
- » Welcome Cocktail, Welcome Dinner, La Chaîne des Rôtisseurs Dinner, Captain's Cocktail and Gala Dinner
- » Complimentary Wi-Fi access on board
- » Guided shore excursions in every port, including Special Interest Tours, hiking and biking tours
- » Onboard live entertainment, theme dinners, cooking demonstration and more
- » Complimentary bicycles, helmets and Nordic walking sticks
- » Services of a professionally trained Cruise Manager throughout your cruise and land stay
- » Transfers between hotel and ship are included with the purchase of cruise and land package

YOUR ITINERARY

Day 1, EMBARKATION - BUDAPEST, HUNGARY. Arrive in Budapest and board your luxurious river cruise ship. During the evening, be treated to a special Illuminations cruise past the capital's glittering river front. (D)

Day 2, BUDAPEST. You cannot help but fall in love with Budapest, known as the "Queen of the Danube" with her distinct blend of medieval and modern beauty. Get to know the city with a tour that begins at the vibrant Great Market Hall packed from floor to ceiling with vendors selling all types of items from food to souvenirs. You'll then visit the UNESCO-listed Castle Hill district, where you can admire dramatic vistas from 19th-century Fisherman's Bastion, St. Stephen's Basilica, Heroes Square, Houses of Parliament and the famous Chain Bridge. (B,L,D)

Day 3, BRATISLAVA - VIENNA. Cruise to the "Coronation City of Kings," where you can join a walking tour or choose to taste local Slovakian specialties and learn how to prepare stuffed potato ravioli. Alternatively, hike up to Bratislava Castle. Later in the day, set sail for Vienna. (B,L,D)

Day 4, VIENNA. The "City of Waltzes" offers a treasure trove of gems and you have two ways to discover them. Join a city tour showcasing its regal splendours, including the majestic Opera House and the former Imperial Palace of the Habsburgs before concluding in Vienna's historic city centre and then visiting St. Stephen's Cathedral. For a more active exploration, take a guided bike ride along the Danube. During the afternoon, you can enjoy leisure time or pedal your way to Klosterneuburg Monastery on a guided cycling tour. (B,L,D)

Day 5, WEISSENKIRCHEN - GREIN. After reaching Weissenkirchen in the heart of the Wachau Valley, you'll be treated to several choices of excursions. Discover the best of both Dürnstein and Melk with a walking tour in Dürnstein before visiting the UNESCO-designated Melk Abbey. You can also opt for a walking tour of Weissenkirchen followed by a visit to the abbey. For those who would like a more culinary-focused experience, join a walking tour in Dürnstein and then be treated to a wine tasting hosted by a local vintner as well as a visit to a local boutique where you'll enjoy a tasting of special apricot treats. Prefer more active adventures? Join a guided bike tour to Melk. Later in the day, set sail through the scenic Strudengau Valley to the medieval riverside town of Grein. Be treated to an exclusive visit to the more than 500-year-old Greinburg Castle, looming regally above the village. While here, enjoy a folklore show along with a sparkling wine reception. (B,L,D)

Day 6, LINZ. The ship arrives in Linz where you'll have several choices of excursions. Opt for a full-day excursion to Salzburg where you'll tour the historic centre, Mirabell Gardens, Residenz Square and the Old Market. En route to Salzburg, stop at Mondsee, home of the famed Basilica St. Michael and site of the wedding scene in "The Sound of Music." Alternatively, you can join a morning walking tour through the old city centre and by the Mozart House; or go on a guided bike tour along the city's famed "Culture Mile" and the Danube. During the afternoon, you have three more options of excursions. Choose a half-day in Salzburg or take a scenic drive through the beautiful Austrian Lake District with a stop in St. Wolfgang. You can also

ENHANCED CRUISES AT NO ADDITIONAL COST



WINE CRUISES (see pages 34-39 for more information)
Add a unique, epicurean dimension to your itinerary.

Complimentary Bonus Features:

- ◆ Special tours and tastings at local wineries and private cellars
- ◆ Learn about winemaking in renowned vineyards
- ◆ Onboard wine pairings with award-winning cuisine
- ◆ A wine expert who leads tastings and discussions

Embark dates: 2018 - Mar 23, Mar 30, Jul 20, Aug 3,
Oct 26, Nov 2, Nov 4

MELODIES OF THE DANUBE

choose to visit the charming mountain town, Český Krumlov, located just over the Czech-Austrian border. (B,L,D)

Day 7, PASSAU – VILSHOFEN. Discover the 2,000-year-old city of Passau in one of three ways. Enjoy a walking tour and marvel at Gothic and Italian Baroque architecture and St. Stephen's Cathedral. Guests looking for a more active morning can choose between a guided bike tour along the Danube River, or a guided hike up to the Veste Oberhaus Fortress. Later, the ship cruises to Vilshofen, where you will be treated to a festive Oktoberfest celebration with local beer, Bavarian folk music and dancing—an AmaWaterways exclusive. (B,L,D)

Day 8, DISEMBARKATION – VILSHOFEN. After breakfast, bid farewell to the town of Vilshofen and prepare for your journey home. (B)

LAND PROGRAMME OPTIONS – POST-CRUISE

MUNICH – 3 NIGHTS

En route to Munich, stop at the BMW World and Museum for a tour of the complex. Alternatively, visit the summer residence of the Bavarian monarchs, Nymphenburg Palace, and enjoy its Baroque splendour. Continue on to Munich, with a panoramic tour of the city. A walking tour of Munich and through the Old Town will reveal iconic sights such as the 15th-century “Cathedral of Our Lady” with its typical domes, the famous outdoor market of Munich and the Rathaus-Glockenspiel at Munich's New Town Hall.

OTHER ITINERARY OPTIONS

7-night cruise and 3 nights in Prague at the InterContinental Prague (or similar)

From an additional **£520** per person (added to the 7-night cruise price).
Single Supplement **£320** per person.

For more information, visit www.amawaterways.co.uk

DATES AND FARES (£)

EMBARK DATE	START CITY	SHIP NAME	7-NIGHT CRUISE
Mar 23	Budapest	AmaViola	£1,778
Mar 30	Budapest	AmaSerena	£1,845
Apr 06	Budapest	AmaViola	£1,978
Apr 13	Budapest	AmaSerena	£2,045
Apr 20	Budapest	AmaViola	£2,178
Apr 27	Budapest	AmaSerena	£2,245
May 04	Budapest	AmaViola	£2,311
May 11	Budapest	AmaSerena	£2,378
May 18	Budapest	AmaViola	£2,378
May 20	Budapest	AmaLea	£2,378
May 25	Budapest	AmaSerena	£2,378
Jun 01	Budapest	AmaViola	£2,378
Jun 03	Budapest	AmaLea	£2,378
Jun 08	Budapest	AmaSerena	£2,378
Jun 15	Budapest	AmaViola	£2,378
Jun 17	Budapest	AmaLea	£2,378
Jun 22	Budapest	AmaSerena	£2,378
Jun 29	Budapest	AmaViola	£2,378
Jul 01	Budapest	AmaLea	£2,311
Jul 06	Budapest	AmaSerena	£2,311
Jul 13	Budapest	AmaViola	£2,311
Jul 15	Budapest	AmaLea	£2,311
Jul 20	Budapest	AmaSerena	£2,311
Jul 27	Budapest	AmaViola	£2,311
Jul 29	Budapest	AmaLea	£2,311
Aug 03	Budapest	AmaSerena	£2,311
Aug 10	Budapest	AmaViola	£2,311
Aug 12	Budapest	AmaLea	£2,311
Aug 17	Budapest	AmaSerena	£2,378
Aug 24	Budapest	AmaViola	£2,445
Aug 26	Budapest	AmaLea	£2,445
Aug 31	Budapest	AmaSerena	£2,511
Sep 07	Budapest	AmaViola	£2,511
Sep 09	Budapest	AmaLea	£2,511
Sep 14	Budapest	AmaSerena	£2,511
Sep 21	Budapest	AmaViola	£2,511
Sep 23	Budapest	AmaLea	£2,511
Sep 28	Budapest	AmaSerena	£2,511
Oct 05	Budapest	AmaViola	£2,511
Oct 07	Budapest	AmaLea	£2,445
Oct 12	Budapest	AmaSerena	£2,378
Oct 19	Budapest	AmaViola	£2,311
Oct 21	Budapest	AmaLea	£2,245
Oct 26	Budapest	AmaSerena	£2,178
Nov 02	Budapest	AmaViola	£2,111
Nov 04	Budapest	AmaLea	£2,111
Dec 16	Budapest	AmaLea	£2,045
Dec 28	Budapest	AmaViola	£2,045

- Wine Cruise
- Christmas Cruise
- New Year's Cruise

Visit www.amawaterways.co.uk for detailed itinerary.

Flights: Please call for fares and availability.

Transfers: Budapest Airport to Ship: from £20 per person.
Ship (Vilshofen) to Munich Airport: from £40 per person.

Cruise fares are per person based on double occupancy in a Cat. E, deluxe outside stateroom with window. To upgrade to a higher category, add per person:

CAT.	DECK	STATEROOM	ADD'L
D	Piano	Window	£199
CB	Violin	French Balcony	£399
CA/C	Violin & Cello	French Balcony	£599
BB	Cello	French/Outside Balcony	£933
BA	Violin	French/Outside Balcony	£1,066
AB	Cello	French/Outside Balcony	£1,199
AA	Violin	French/Outside Balcony	£1,333
AA+	Violin	French/Outside Balcony	£1,733
Suite	Violin	French/Outside Balcony	£2,199

Port Charges: Fares include port charges of £112 per person

Single Supplement: Categories E – AA: add 50% per person; Categories AA+ and Suite: add 100% per person. Single supplement may be waived on D and E categories subject to availability. Please check at time of booking.

Bedding: Please select bedding configuration at the time of booking.

Option A: Two twin beds

Option B: One large bed (larger than queen size)

Deck Plans: AMALEA & AMAVIOLA – See page 164.

AMASERENA – See page 166.

LAND PROGRAMMES

POST-CRUISE – 3 NIGHTS MUNICH from £880 per person

Additional Hotel Nights (prices subject to change due to seasonality):

Prices are per person

Munich: Double occupancy – £177, Single occupancy – £354

Budapest: Double occupancy – £100, Single occupancy – £200

Prague: Double occupancy – £94, Single occupancy – £187

Upgrade to the Four Seasons in Prague is available; ask for details.

Additional hotel nights include portage, breakfast, as well as transfers to/from the ship only in cities where the ship is embarking or disembarking.

Single Supplement: 3 Nights Munich £320 per person

For more information on hotels, please see page 42.



GREINBURG CASTLE, GREIN, AUSTRIA

THE DANUBE RIVER



LEGENDARY DANUBE

7 NIGHTS • NUREMBERG TO BUDAPEST

CRUISE ALONG THE ICONIC MAIN-DANUBE CANAL, A CRUCIAL LANDMARK IN THE HISTORY OF RIVER CRUISING, HEADING TOWARDS BUDAPEST



Delve into Europe's history as you cruise through the man-made marvel, the Main-Danube Canal, across the Continental Divide and through the Wachau Valley. Explore perfectly preserved medieval cities, such as Nuremberg and Regensburg, and visit Vienna where imperial dynasties built a harmonious blend of architectural wonders. Throughout your journey, get a feel for the land by biking and hiking, and sampling delicate wines and hearty beers.



MELK ABBEY, AUSTRIA



CHARLES BRIDGE, PRAGUE, CZECH REPUBLIC

DAILY PROGRAMME FEATURES

DAY	DESTINATION	ACTIVITIES
1	Nuremberg, Germany	✳ EMBARKATION
2	Nuremberg	Medieval city tour OR WWII city tour Cruise Main-Danube Canal
3	Regensburg, Germany	Walking tour OR Walhalla bike tour OR Bavarian specialties tasting
4	Passau, Germany	Walking tour OR Passau bike tour OR Passau Castle hike
	Linz, Austria	Scenic cruising
5	Melk, Austria	Benedictine Abbey tour OR Danube bike tour OR Dürnstein walking tour
	Wachau Valley, Austria	Scenic cruising
	Vienna, Austria	Free time
6	Vienna	City tour OR Alte Donau bike tour Klosterneuburg bike tour OR Free time
7	Budapest, Hungary	City tour OR Castle Hill hike Free time Illuminations cruise
8	Budapest	⬇ DISEMBARKATION

✳ Embark 7-Night Cruise

⬇ Disembark 7-Night Cruise

Note: Bike tours and hikes subject to weather and seasonality.

For full itinerary details, visit www.amawaterways.co.uk

INCLUDED FEATURES

- » 7 nights deluxe cruise accommodation in riverview stateroom or suite - most staterooms and suites offer twin balconies
- » Entertainment-On-Demand in all staterooms featuring free high-speed internet access, movies, a music library and English language TV stations
- » Fine dining, including unlimited complimentary hand-selected wines, beer and soft drinks with lunch and dinner on board
- » Multiple dining venues, including The Chef's Table specialty restaurant featuring our unique tasting menu
- » **NEW FOR 2018 - Sip & Sail daily cocktail hour with complimentary wine, beer, spirits and soft drinks**
- » Welcome Cocktail, Welcome Dinner, La Chaîne des Rôtisseurs Dinner, Captain's Cocktail and Gala Dinner
- » Complimentary Wi-Fi access on board
- » Guided shore excursions in every port, including Special Interest Tours, hiking and biking tours
- » Onboard live entertainment, theme dinners, cooking demonstration and more
- » Complimentary bicycles, helmets and Nordic walking sticks
- » Services of a professionally trained Cruise Manager throughout your cruise and land stay
- » Transfers between hotel and ship are included with the purchase of cruise and land package

YOUR ITINERARY

Day 1, EMBARKATION - NUREMBERG, GERMANY. Meet your fellow travellers at a Welcome Dinner. The ship will moor overnight in Nuremberg. (D)

Day 2, NUREMBERG. You have two choices of excursions while in Nuremberg: one focusing on the medieval highlights and another focusing on WWII. Enjoy a guided tour through this beautiful medieval city, showcasing the Imperial Castle, famous town wall and the legendary fountain of the Market Square. Or turn back the pages of a darker history with a guided tour of the city's most important WWII sites, including the enormous Documentation Centre Nazi Party Rally Grounds. You'll also visit the Nuremberg Trials Memorial, and Courtroom 600 if the courtroom is not in session. En route to Regensburg, you'll cruise through the man-made marvel, the Main-Danube Canal. (B,L,D)

Day 3, REGENSBURG. Explore one of Germany's best preserved medieval cities Regensburg on a guided walking tour showcasing the city's architectural highlights, including the Old Town Hall and the Porta Praetoria. Alternatively, sample some Bavarian specialties—beer, sausage and pretzels, and for those who wish to be more

active, join a bike tour to Walhalla where you will see the Neoclassical white marble temple inspired by the Parthenon in Athens. (B,L,D)

Day 4 PASSAU - LINZ. Enjoy a walking tour along Passau's cobblestone streets admiring the Gothic and Italian Baroque architecture and St. Stephen's Cathedral. For guests looking for a more active morning, you can choose between a guided bike tour along the Danube River, or a guided hike up to the Veste Oberhaus Fortress for panoramic views overlooking three rivers. Later in the day, set sail for Linz. (B,L,D)

Day 5, MELK - VIENNA. Cruise to Melk, known for its magnificent Benedictine Abbey, a UNESCO World Heritage Site and one of Europe's largest and most revered monasteries. Alternatively, you can join a guided bike tour that takes you through the UNESCO-designated Wachau Valley; or go on a walking tour along Dürnstein's cobblestone streets to the Baroque Stiftskirche, famed church tower. Later in the day, set sail through the vineyard-rich Wachau Valley. (B,L,D)

Day 6, VIENNA. The "City of Waltzes" offers a treasure trove of gems and you have two ways to discover them.



LEGENDARY DANUBE

Join a city tour showcasing its regal splendours, including the majestic Opera House and the former Imperial Palace of the Habsburgs before concluding in Vienna's historic city centre, a UNESCO World Heritage Site, and then visiting St. Stephen's Cathedral. For a more active exploration of the area, take a guided bike ride along the Danube. During the afternoon, you can enjoy leisure time or pedal your way to Klosterneuburg Monastery on a guided cycling tour. (B,L,D)

Day 7, BUDAPEST. You cannot help but fall in love with Budapest, known as the "Queen of the Danube." Your city tour begins with visit to the vibrant Great Market Hall brimming with vendors selling everything from food to souvenirs. The remainder of this tour takes you to both the Buda (hilly) and the Pest (flat) sides of the river. As an alternative choice, hike up to Castle Hill for breathtaking views of the city below. Spend your last evening on board cruising around the famed Parliament Building as the city turns on all her dazzling lights. (B,L,D)

Day 8, DISEMBARKATION – BUDAPEST. Bid farewell to Budapest as you prepare for your flight home. (B)



ADMIRE GRAND MASTERPIECES

LAND PROGRAMME OPTIONS – PRE-CRUISE

PRAGUE – 3 NIGHTS

Experience the wonders of Prague and its historic city centre that is a recognised UNESCO World Heritage Site. See Rudolfinum, the National Museum, Wenceslas Square and the Hundertwasser Dancing House. Visit the 1,000 year-old Prague Castle and St. Vitus before walking over the romantic Charles Bridge to the Old Market Square, where you will find the capital's famous Astronomical Clock. Wander through the city admiring its diversity of architectural styles: Gothic, Renaissance, Baroque, Rococo and Art Nouveau. On route to Nuremberg, enjoy a stop in Pilzen for a local highlights tour, then continue on to join your ship.

DATES AND FARES (£)

EMBARK DATE	START CITY	SHIP NAME	7-NIGHT CRUISE
Apr 07	Nuremberg	AmaCerto	£1,978
May 05	Nuremberg	AmaCerto	£2,311
Jun 02	Nuremberg	AmaCerto	£2,378
Jun 30	Nuremberg	AmaCerto	£2,311
Jul 01	Nuremberg	AmaSonata	£2,311
Jul 14	Nuremberg	AmaCerto	£2,311
Jul 29	Nuremberg	AmaSonata	£2,311
Aug 11	Nuremberg	AmaCerto	£2,311
Aug 25	Nuremberg	AmaCerto	£2,445
Aug 26	Nuremberg	AmaSonata	£2,445
Sep 08	Nuremberg	AmaCerto	£2,511
Sep 23	Nuremberg	AmaSonata	£2,511
Oct 06	Nuremberg	AmaCerto	£2,445
Oct 21	Nuremberg	AmaSonata	£2,245
Nov 03	Nuremberg	AmaCerto	£2,111

Flights: Please call for fares and availability.

Transfers: Nuremberg Airport to Ship: from £24 per person.
Ship to Budapest Airport: from £20 per person.

Cruise fares are per person based on double occupancy in a Cat. E, deluxe outside stateroom with window. To upgrade to a higher category, add per person:

CAT.	DECK	STATEROOM	ADD'L
D	Piano	Window	£199
C	Violin & Cello	French Balcony	£599
BB	Cello	French/Outside Balcony	£933
BA	Violin	French/Outside Balcony	£1,066
AB	Cello	French/Outside Balcony	£1,199
AA	Violin	French/Outside Balcony	£1,333
AA+	Violin	French/Outside Balcony	£1,733
Suite	Violin	French/Outside Balcony	£2,199

Port Charges: Fares include port charges of £112 per person

Single Supplement: Categories E – AA: add 50% per person; Categories AA+ and Suite: add 100% per person. Single supplement may be waived on D and E categories subject to availability. Please check at time of booking.

Bedding: Please select bedding configuration at the time of booking.

Option A: Two twin beds

Option B: One large bed (larger than queen size)

Deck Plans: AMACERTO & AMASONATA – See page 166.

LAND PROGRAMMES

PRE-CRUISE – 3 NIGHTS PRAGUE from £520 per person

Additional Hotel Nights (prices subject to change due to seasonality):

Prices are per person

Prague: Double occupancy – £94, Single occupancy – £187

Budapest: Double occupancy – £100, Single occupancy – £200

Nuremberg: Double occupancy – £124, Single occupancy – £247

Upgrade to the Four Seasons in Prague is available; ask for details.

Additional hotel nights include portage, breakfast, as well as transfers to/from the ship only in cities where the ship is embarking or disembarking.

Single Supplement: 3 Nights Prague £320 per person

For more information on hotels, please see page 42.

THE DANUBE RIVER



BLUE DANUBE DISCOVERY

7 NIGHTS • BUDAPEST TO NUREMBERG

ENJOY THE MYSTICAL DANUBE, TRAVELLING WEST FROM HUNGARY TO GERMANY, CONCLUDING YOUR TRIP IN HISTORIC NUREMBERG



Discover a wealth of art, history and cultural treasures as you cruise to some of Europe's most famous destinations. From Budapest, journey to Bratislava, Vienna, Passau and the 2,000-year-old town of Regensburg, a UNESCO World Heritage Site. Along the way, visit magnificent cathedrals and Baroque abbeys, sample Vienna's sinfully rich sachertorte cake, experience the breathtaking scenery of the Wachau Valley winemaking region and traverse Europe's Continental Divide.



ASTRONOMICAL CLOCK, PRAGUE



HEROES' SQUARE, BUDAPEST, HUNGARY

DAILY PROGRAMME FEATURES

DAY	DESTINATION	ACTIVITIES
1	Budapest, Hungary	✳ EMBARKATION Illuminations cruise
2	Bratislava, Slovakia	Walking tour OR Castle hike
3	Vienna, Austria	City tour OR Alta Donau bike tour Klosterneuburg Abbey bike ride OR Free time
4	Dürnstein, Austria	Walking tour and wine tasting Dürnstein Fortress hike OR Apricots and Sweets tasting Cruising the Wachau Valley OR Danube bike tour
	Melk, Austria	Benedictine Abbey tour
5	Passau, Germany	Walking tour OR Passau bike tour OR Passau Castle hike
6	Regensburg, Germany	Walking tour Walhalla bike tour OR Bavarian specialties tasting
7	Nuremberg, Germany	Medieval city tour OR WWII city tour OR Franconian specialties tasting
8	Nuremberg	⚓ DISEMBARKATION

✳ Embark 7-Night Cruise

⚓ Disembark 7-Night Cruise

Note: Bike tours and hikes subject to weather and seasonality.

For full itinerary details, visit www.amawaterways.co.uk

INCLUDED FEATURES

- » 7 nights deluxe cruise accommodation in riverview stateroom or suite - most staterooms and suites offer twin balconies
- » Entertainment-On-Demand in all staterooms featuring free high-speed internet access, movies, a music library and English language TV stations
- » Fine dining, including unlimited complimentary hand-selected wines, beer and soft drinks with lunch and dinner on board
- » Multiple dining venues, including The Chef's Table specialty restaurant featuring our unique tasting menu
- » **NEW FOR 2018 - Sip & Sail daily cocktail hour with complimentary wine, beer, spirits and soft drinks**
- » Welcome Cocktail, Welcome Dinner, La Chaîne des Rôtisseurs Dinner, Captain's Cocktail and Gala Dinner
- » Complimentary Wi-Fi access on board
- » Guided shore excursions in every port, including Special Interest Tours, hiking and biking tours
- » Onboard live entertainment, theme dinners, cooking demonstration and more
- » Complimentary bicycles, helmets and Nordic walking sticks
- » Services of a professionally trained Cruise Manager throughout your cruise and land stay
- » Transfers between hotel and ship are included with the purchase of cruise and land package

YOUR ITINERARY

Day 1, EMBARKATION - BUDAPEST, HUNGARY. Arrive in Budapest and embark your ship. Tonight, meet your fellow travellers at the Welcome Dinner as the ship cruises to Bratislava. (D)

Day 2, BRATISLAVA. Bratislava certainly has earned the title "Coronation City of Kings" as you'll discover during your walking tour that includes the Old Town Hall, Mirbach Palace and St. Martin's Cathedral. Or for more adventure, go high above the city by hiking up to Bratislava Castle. (B,L,D)

Day 3, VIENNA. The "City of Waltzes" offers a treasure trove of gems and you have two ways to discover them. Join a city tour showcasing its regal splendours, including the majestic Opera House and the former Imperial Palace of the Habsburgs before concluding in Vienna's historic city centre, a UNESCO World Heritage Site, and then visiting St. Stephen's Cathedral. For a more active exploration of the area, take a guided bike ride along the Danube. During the afternoon, you can enjoy leisure time or pedal your way to Klosterneuburg Monastery on a guided cycling tour. (B,L,D)

Day 4, DÜRNSTEIN - MELK. After reaching the Wachau Valley in the morning, you'll have a choice of three

excursions in Dürnstein. Partake in a walking tour along cobblestone streets to the luminous blue facade of the Baroque Stiftskirche, its famed church tower, before enjoying a wine tasting in a local cellar. For a beautiful view of the Wachau Valley, hike up to the fortress where Richard the Lionheart was once held. Alternatively, visit a local boutique, where you'll be treated to the region's finest apricot products. After your morning excursions, you have a choice to cruise through the Wachau Valley to Melk or join a bike tour along the Danube. Upon reaching Melk, take a tour of the UNESCO-designated Melk Abbey. (B,L,D)

Day 5, PASSAU. Enjoy a scenic morning sailing to the medieval city of Passau. Join a walking tour through this 2,000-year-old city, noted for its Gothic and Italian Baroque architecture and St. Stephen's Cathedral. Guests looking for a more active morning can choose between a guided bike tour along the Danube, or a guided hike up to the Veste Oberhaus Fortress overlooking Passau. (B,L,D)

Day 6, REGENSBURG. Explore Regensburg, one of Germany's best preserved medieval cities, on a guided walking tour showcasing the city's architectural highlights, including the Old Town Hall and the Porta Praetoria, gates to an ancient Roman fort built in 179 A.D. As an



ILLUMINATIONS CRUISE, BUDAPEST

BLUE DANUBE DISCOVERY

alternative, sample some of Bavaria's specialties—beer, sausage and pretzels; or bike to Walhalla where you'll see the neo-Classical white marble temple inspired by the Parthenon in Athens. (B,L,D)

Day 7, NUREMBERG. Enjoy a scenic morning cruise as the ship crosses the Continental Divide via the Main-Danube Canal to Nuremberg. Explore the medieval city centre with a tour that showcases the Imperial Castle and the famous town wall, as well as Albrecht Dürer's home and Market Square with its legendary fountain. Or you can take a guided tour of the city's WWII history, including a visit to the infamous Zeppelin Field, a museum built on the site of former Nazi rallies and the site of the Nuremberg Trials when not in session. Alternatively, savour traditional Franconian specialties by sampling famously delicious Nuremberger Bratwurst, Rot beer (red beer) and Lebkuchen (gingerbread). (B,L,D)

Day 8, DISEMBARKATION – NUREMBERG. Depart the ship after breakfast and prepare for your onward journey. (B)



REGENSBURG, GERMANY

LAND PROGRAMME OPTIONS – PRE-CRUISE

BUDAPEST – 2 NIGHTS

Arrive in Budapest and transfer to your hotel in the historic city. The remainder of the day is free to relax or to begin exploring the beautiful sights. Morning excursions will take in the delights of both cities, Buda and Pest, spread over both banks of the river. You will see the famed Heroes' Square and Castle Hill, home to Fisherman's Bastion, Matthias Church and of course some spectacular views of the Danube, making this the perfect introduction to your journey.

LAND PROGRAMME OPTIONS – POST-CRUISE

PRAGUE – 3 NIGHTS

A scenic drive through pastoral countryside will bring you to Pilsen. In the city perhaps best known for producing Pilsner beer, you will have free time to explore the lovely town and have lunch before continuing to Prague. Choose between a standard city tour or a hike, to reveal why Prague is considered one of Europe's most attractive cities. You will discover the historic city centre that's recognised as a UNESCO World Heritage Site. Visit the 1,000 year-old Prague Castle and St. Vitus before walking over the romantic Charles Bridge to the Old Market Square, where you will find the capital's famous Astronomical Clock. Free to explore, perhaps stroll through a museum or gallery, wander along the banks of the Vltava River or shop for local handicrafts.

DATES AND FARES (£)

EMBARK DATE	START CITY	SHIP NAME	7-NIGHT CRUISE
Mar 31	Budapest	AmaCerto	£1,845
Apr 28	Budapest	AmaCerto	£2,245
May 26	Budapest	AmaCerto	£2,378
Jun 10	Budapest	AmaSonata	£2,378
Jun 23	Budapest	AmaCerto	£2,378
Jul 07	Budapest	AmaCerto	£2,311
Jul 08	Budapest	AmaSonata	£2,311
Aug 04	Budapest	AmaCerto	£2,311
Aug 05	Budapest	AmaSonata	£2,311
Aug 18	Budapest	AmaCerto	£2,378
Sep 01	Budapest	AmaCerto	£2,511
Sep 02	Budapest	AmaSonata	£2,511
Sep 29	Budapest	AmaCerto	£2,511
Sep 30	Budapest	AmaSonata	£2,511
Oct 27	Budapest	AmaCerto	£2,178
Oct 28	Budapest	AmaSonata	£2,178
Nov 09	Budapest	AmaSerena	£2,045
Nov 10	Budapest	AmaCerto	£1,978
Nov 16	Budapest	AmaViola	£1,978
Nov 18	Budapest	AmaLea	£1,978

Flights: Please call for fares and availability.

Transfers: Budapest Airport to Ship: from £20 per person.

Ship to Nuremberg Airport: from £24 per person.

Cruise fares are per person based on double occupancy in a Cat. E, deluxe outside stateroom with window. To upgrade to a higher category, add per person:

CAT.	DECK	STATEROOM	ADD'L
D	Piano	Window	£199
CB	Violin	French Balcony	£399
CA/C	Violin & Cello	French Balcony	£599
BB	Cello	French/Outside Balcony	£933
BA	Violin	French/Outside Balcony	£1,066
AB	Cello	French/Outside Balcony	£1,199
AA	Violin	French/Outside Balcony	£1,333
AA+	Violin	French/Outside Balcony	£1,733
Suite	Violin	French/Outside Balcony	£2,199

Port Charges: Additional £112 per person

Single Supplement: Categories E – AA: add 50% per person; Categories AA+ and Suite: add 100% per person. Single supplement may be waived on D and E categories subject to availability. Please check at time of booking.

Bedding: Please select bedding configuration at the time of booking. Option A: Two twin beds. Option B: One large bed (larger than queen size)

Deck Plans: AMALEA & AMAVIOLA – See page 164.

AMACERTO, AMASERENA & AMASONATA – See page 166.

LAND PROGRAMMES

PRE-CRUISE – 2 NIGHTS BUDAPEST from £347 per person

POST-CRUISE – 3 NIGHTS PRAGUE from £520 per person

Additional Hotel Nights (prices subject to change due to seasonality):

Prices are per person

Prague: Double occupancy – £94, Single occupancy – £187

Budapest: Double occupancy – £100, Single occupancy – £200

Nuremberg: Double occupancy – £124, Single occupancy – £247

Upgrade to the Four Seasons in Prague and Budapest is available; ask for details.

Additional hotel nights include portage, breakfast, as well as transfers to/from the ship only in cities where the ship is embarking or disembarking.

Single Supplement:

2 Nights Budapest £213 per person **3 Nights Prague** £320 per person

For more information on hotels, please see page 42.

THE DANUBE RIVER

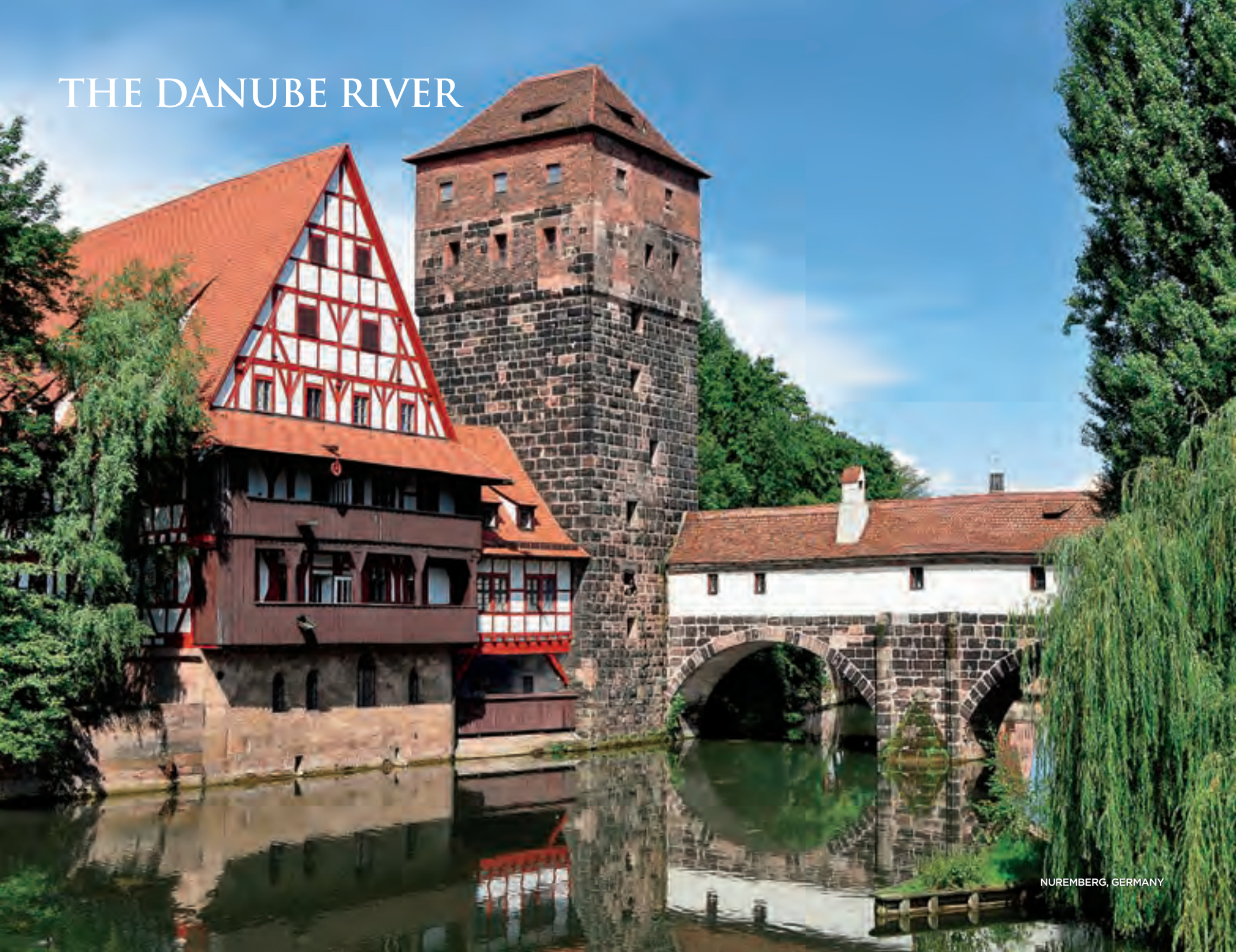

DANUBE SERENADE

7 NIGHTS • NUREMBERG TO VIENNA (OR REVERSE)

DISCOVER THE CLASSICAL BEAUTY OF VIENNA AND THE MODERN HISTORY OF NUREMBERG AS YOU CRUISE THE DANUBE



Discover the undeniable fairytale beauty of the Danube as you explore the towns that line its banks. Glimpse into the bygone grandeur of Vienna and explore places such as Nuremberg where history is not only portrayed but an essential part of daily life. Fall in love with Old World Europe as you let the melodious Danube serenade you.



SAMPLE LOCAL WINES



SALZBURG, AUSTRIA

DAILY PROGRAMME FEATURES

DAY	DESTINATION	ACTIVITIES
1	Nuremberg, Germany	✳️ EMBARKATION
2	Nuremberg	Medieval city tour OR WWII city tour Cruise Main-Danube Canal
3	Regensburg, Germany	Walking tour OR Walhalla bike tour OR Bavarian specialties tasting
4	Passau, Germany	Walking tour OR Passau bike tour OR Passau Castle Hike
5	Linz, Austria	Walking tour OR Full-day Salzburg OR Castle and "Culture Mile" bike tour Half-day Salzburg OR Český Krumlov OR Austrian Lake District
6	Melk, Austria	Benedictine Abbey tour OR Danube bike tour
	Wachau Valley	Scenic cruising
	Dürnstein, Austria	Walking tour and wine tasting OR Dürnstein Fortress hike OR Apricots and Sweets tasting
	Krems, Austria	Wine tasting OR Walking tour
7	Vienna, Austria	City tour OR Sacher & Sekt OR Alte Donau bike tour Klosterneuburg Abbey bike tour OR Free time
8	Vienna	⚓ DISEMBARKATION

✳️ Embark 7-Night Cruise

⚓ Disembark 7-Night Cruise

Note: Bike tours and hikes subject to weather and seasonality.

For full itinerary details, visit www.amawaterways.co.uk

INCLUDED FEATURES

- » 7 nights deluxe cruise accommodation in riverview stateroom or suite – most staterooms and suites offer twin balconies
- » Entertainment-On-Demand in all staterooms featuring free high-speed internet access, movies, a music library and English language TV stations
- » Fine dining, including unlimited complimentary hand-selected wines, beer and soft drinks with lunch and dinner on board
- » Multiple dining venues, including The Chef's Table specialty restaurant featuring our unique tasting menu
- » **NEW FOR 2018 – Sip & Sail daily cocktail hour with complimentary wine, beer, spirits and soft drinks**
- » Welcome Cocktail, Welcome Dinner, La Chaîne des Rôtisseurs Dinner, Captain's Cocktail and Gala Dinner
- » Complimentary Wi-Fi access on board
- » Guided shore excursions in every port, including Special Interest Tours, hiking and biking tours
- » Onboard live entertainment, theme dinners, cooking demonstration and more
- » Complimentary bicycles, helmets and Nordic walking sticks
- » Services of a professionally trained Cruise Manager throughout your cruise and land stay
- » Transfers between hotel and ship are included with the purchase of cruise and land package

YOUR ITINERARY

Day 1, EMBARKATION – NUREMBERG, GERMANY. Meet your fellow travellers at a Welcome Dinner. The ship will moor overnight in Nuremberg. (D)

Day 2, NUREMBERG. Famous for its ancient castle, gingerbread and toy manufacturing, Nuremberg was also home to the infamous WWII-era Zeppelin Field and subsequent War Crimes Trials. You have two choices of excursions: one focusing on the medieval highlights and the second focusing on WWII. Enjoy a guided tour through this well-preserved medieval city, showcasing the Imperial Castle, famous town wall and the legendary fountain of the Market Square. Or turn back the pages of a darker history with a guided tour of the city's most important WWII sites, including the coliseum. You'll also visit the Nuremberg Trials Memoriam, and Courtroom 600 if the courtroom is not in session. Later in the afternoon, cruise through the man-made marvel, the Main-Danube Canal. (B,L,D)

Day 3, REGENSBURG. Regensburg is one of Germany's best preserved medieval cities, and you'll discover why on a guided walking tour showcasing the city's architectural highlights, including the Old Town Hall and the Porta

Praetoria. As an alternative option, sample some Bavarian specialties—beer, sausage and pretzels. If you prefer a more active adventure, join a bike tour to Walhalla where you will see the Neoclassical white marble temple built to honour the memory of famous Germans. (B,L,D)

Day 4, PASSAU. Discover the 2,000-year-old city of Passau in one of three ways. Enjoy a walking tour and marvel at Gothic and Italian Baroque architecture and St. Stephen's Cathedral. Guests looking for a more active morning can choose between a guided bike tour along the Danube River, or a guided hike up to the Veste Oberhaus Fortress for panoramic views overlooking three rivers. (B,L,D)

Day 5, LINZ. Opt for a full-day excursion to Salzburg, Mozart's birthplace, where you'll tour such places as the historic centre and Mirabell Gardens. En route to Salzburg, stop at Mondsee, home of the famed Basilica St. Michael and site of the wedding scene in "The Sound of Music." Alternatively, you can choose two morning excursions in Linz. Join a walking tour through the old city centre and by the Mozart House, where he composed the Linz Symphony in only three days. Or go on a guided bike tour



DANUBE SERENADE

along the city's famed "Culture Mile" and the Danube. During the afternoon, you have three more options of excursions. Choose a half-day tour in Salzburg or take a scenic drive through the beautiful Austrian Lake District with a stop in St. Wolfgang. You can also choose to visit the charming mountain town, Český Krumlov, located just over the Czech-Austrian border. (B,L,D)

Day 6, MELK - DÜRNSTEIN - KREMS. Cruise to Melk, where you can visit its magnificent Benedictine Abbey, a UNESCO World Heritage Site and one of Europe's most revered monasteries. You can also join a guided bike tour through the UNESCO-designated Wachau Valley that will take you to Dürnstein where you'll meet the ship. For those not biking, you'll cruise through the Wachau Valley to Dürnstein. Once here, you have a choice of excursions. Join a walking tour along Dürnstein's cobblestone streets to the luminous blue facade of the Baroque Stiftskirche, before enjoying a local wine tasting. For a more active adventure, hike up to the fortress where Richard the Lionheart was once held. You may also choose to visit a local apricot grower, where you'll enjoy the finest apricot treats in the region. Later set sail to Krems, where you can choose between wine tasting or a walking tour. (B,L,D)

Day 7, VIENNA. Experience the regal elegance of Vienna with one of three different excursions. Join a city tour that takes you by the majestic Opera House and the former Imperial Palace of the Habsburg Emperors. Afterwards, visit Vienna's historic city centre, a UNESCO World Heritage Site, and see St. Stephen's Cathedral and the world famous Spanish Riding School. Alternatively, join an exclusive tour to a famous Viennese café for a taste of sacherorte, a sinfully rich chocolate cake, and sekt, an Austrian sparkling wine. For those who prefer to get more active, you can cycle along the Danube and through the Donaupark. During the afternoon, enjoy free time or bike to the majestic twelfth-century Klosterneuburg Monastery. (B,L,D)

Day 8, DISEMBARKATION - VIENNA. Disembark your ship after breakfast and prepare for your onward journey. (B)

LAND PROGRAMME OPTIONS – PRE-CRUISE

PRAGUE - 3 NIGHTS

Discover Prague with a choice of a city tour or a castle hike. Both will reveal why Prague is considered one of Europe's most attractive cities, with a historic city centre that's recognized as a UNESCO World Heritage Site. See all the key highlights, including the National Museum, Wenceslas Square, the 1,000 year-old Prague Castle and Old Market Square. Enjoy a stop in Pilsen, known for producing Pilsner beer and after a walking tour of local highlights, drive to Nuremberg where you will board your ship.

LAND PROGRAMME OPTIONS – POST-CRUISE

VIENNA - 2 NIGHTS

Uncover "Vienna's Royal Treasures" at the Hofburg Palace, the former residence of the Habsburgs. You'll visit the lavishly decorated Imperial Apartments and Imperial Treasury, home to many of the Habsburg's treasures, including the Crown of the Holy Roman Empire and the Austrian Imperial Crown.



BIKE TOUR IN VIENNA, AUSTRIA

DATES AND FARES (£)

EMBARK DATE	START CITY	SHIP NAME	7-NIGHT CRUISE
Jun 17	Nuremberg	AmaSonata	£2,378
Jun 24	Vienna	AmaSonata	£2,378
Jul 15	Nuremberg	AmaSonata	£2,311
Jul 22	Vienna	AmaSonata	£2,311
Aug 12	Nuremberg	AmaSonata	£2,311
Aug 19	Vienna	AmaSonata	£2,378
Sep 09	Nuremberg	AmaSonata	£2,511
Sep 16	Vienna	AmaSonata	£2,511
Oct 07	Nuremberg	AmaSonata	£2,445
Oct 14	Vienna	AmaSonata	£2,378
Nov 04	Nuremberg	AmaSonata	£2,045
Nov 11	Vienna	AmaSonata	£1,978
Nov 16	Nuremberg	AmaSerena	£1,978
Nov 17	Nuremberg	AmaCerto	£1,978
Nov 18	Nuremberg	AmaSonata	£1,978

Flights: Please call for fares and availability.

Transfers: Vienna Airport to Ship (or reverse): from £20 per person.

Ship to Nuremberg Airport (or reverse): from £24 per person

Cruise fares are per person based on double occupancy in a Cat. E, deluxe outside stateroom with window. To upgrade to a higher category, add per person:

CAT.	DECK	STATEROOM	ADD'L
D	Piano	Window	£199
C	Violin & Cello	French Balcony	£599
BB	Cello	French/Outside Balcony	£933
BA	Violin	French/Outside Balcony	£1,066
AB	Cello	French/Outside Balcony	£1,199
AA	Violin	French/Outside Balcony	£1,333
AA+	Violin	French/Outside Balcony	£1,733
Suite	Violin	French/Outside Balcony	£2,199

Port Charges: Fares include port charges of £112 per person

Single Supplement: Categories E-AA: add 50% per person; Categories AA+ and Suite: add 100% per person. Single supplement may be waived on D and E categories subject to availability. Please check at time of booking.

Bedding: Please select bedding configuration at the time of booking.

Option A: Two twin beds

Option B: One large bed (larger than queen size)

Deck Plans: AMACERTO, AMASERENA & AMASONATA - See page 166.

LAND PROGRAMMES

PRE-CRUISE - 3 NIGHTS PRAGUE from £520 per person

POST-CRUISE - 2 NIGHTS VIENNA from £347 per person

Additional Hotel Nights (prices subject to change due to seasonality):

Prices are per person

Prague: Double occupancy - £94, Single occupancy - £187

Vienna: Double occupancy - £90, Single occupancy - £180

Nuremberg: Double occupancy - £124, Single occupancy - £247

Upgrade to the Four Seasons in Prague is available; ask for details.

Additional hotel nights include portage, breakfast, as well as transfers to/from the ship only in cities where the ship is embarking or disembarking.

Single Supplement:

3 Nights Prague £320 per person **2 Nights Vienna** £213 per person

For more information on hotels, please see page 42.

THE DANUBE RIVER



CRUISING THROUGH THE IRON GATES

GEMS OF SOUTHEAST EUROPE

7 NIGHTS - BUDAPEST TO GIURGIU (OR REVERSE)

CRUISE SOUTH FROM HUNGARY, SAILING THROUGH THE ICONIC IRON GATES INTO EASTERN EUROPE



Traverse the dramatic narrow gorge known as the Iron Gates as you cruise along the Romanian/Bulgarian border. Visit Vidin with its stunning landscapes of unusual rock formations, then onto Belogradchik, one of Bulgaria's natural wonders. Discover spectacular rock formations and Neo-Baroque and Neo-Rococo architecture as you sail towards Giurgiu.



UNIQUE LOCALLY-MADE HANDICRAFTS



BELGRADCHIK, BULGARIA

DAILY PROGRAMME FEATURES

DAY	DESTINATION	ACTIVITIES
1	Budapest, Hungary	EMBARKATION Illuminations cruise
2	Mohács, Hungary	Scenic cruising Pécs excursion
3	Vukovar, Croatia Ilok, Croatia Novi Sad, Serbia	City tour OR Croatian wine tasting Walking tour OR Bike tour OR Hike tour Evening Petrovaradin Fortress visit
4	Belgrade, Serbia	City tour Royal Palace and Tito's Memorial tour OR Quburich Brandy tasting OR Belgrade bike tour
5	Iron Gates, Serbia	Full-day scenic cruising
6	Vidin, Bulgaria	Baba Vida Fortress and Belogradchik hike OR Banitsa pastry and yoghurt tasting OR Vidin bike tour
7	Rousse, Bulgaria Giurgiu, Romania	Veliko Tarnovo excursion OR Rousse walking tour and Rock-hewn Churches tour Free evening
8	Giurgiu	DISEMBARKATION

Embark 7-Night Cruise

Disembark 7-Night Cruise

Note: Bike tours and hikes subject to weather and seasonality.

For full itinerary details, visit www.amawaterways.co.uk

INCLUDED FEATURES

- » 7 nights deluxe cruise accommodation in riverview stateroom or suite – most staterooms and suites offer twin balconies
- » Entertainment-On-Demand in all staterooms featuring free high-speed internet access, movies, a music library and English language TV stations
- » Fine dining, including unlimited complimentary hand-selected wines, beer and soft drinks with lunch and dinner on board
- » Multiple dining venues, including The Chef's Table specialty restaurant featuring our unique tasting menu
- » **NEW FOR 2018 – Sip & Sail daily cocktail hour with complimentary wine, beer, spirits and soft drinks**
- » Welcome Cocktail, Welcome Dinner, La Chaîne des Rôtisseurs Dinner, Captain's Cocktail and Gala Dinner
- » Complimentary Wi-Fi access on board
- » Guided shore excursions in every port, including Special Interest Tours, hiking and biking tours
- » Onboard live entertainment, theme dinners, cooking demonstration and more
- » Complimentary bicycles, helmets and Nordic walking sticks
- » Services of a professionally trained Cruise Manager throughout your cruise and land stay
- » Transfers between hotel and ship are included with the purchase of cruise and land package

YOUR ITINERARY

Day 1, EMBARKATION – BUDAPEST, HUNGARY. After a Welcome Dinner, the ship will sail a special Illuminations Cruise past the glittering riverfront of Budapest. (D)

Day 2, MOHÁCS – PÉCS. Enjoy a scenic morning cruise to Pécs, founded more than 2,000 years ago by the Romans. Visit the UNESCO-designated Christian Necropolis; St. Peter's Basilica, the city's main Catholic cathedral along with its catacombs; and Széchenyi Square, the heart of Old Town Pécs. You will also see the Mosque of Pasha Qasim the Victorious, one of the symbols of the city. (B,L,D)

Day 3, VUKOVAR, CROATIA – NOVI SAD. Vukovar is a Croatian symbol of resistance, which you'll better understand on your city tour showcasing the Ovčara Memorial and Eltz Palace. Alternatively, choose a wine tasting in Ilok, a centre of wine production since Roman times, where you'll sample its famous Grasevina, Traminac and Frankovka wines. Back on board, cruise to Novi Sad, sometimes called the "Serbian Athens." Discover Novi Sad on a walking tour to Dunavski Park and through Stari Grad, the Old Town centre. If you prefer a more active exploration, join a guided biking or hiking tour. During the evening, visit Petrovaradin Fortress, a mighty stronghold no enemy has ever breached. (B,L,D)

Day 4, BELGRADE. Explore Serbia's capital, Belgrade, on a city tour, which includes the Kalemegdan Fortress and the Serbian Orthodox Temple of St. Sava. Later, choose from three intriguing excursions. Visit the Royal Palace, the official residence of the Serbian Royal Family; and then tour the House of Flowers, the mausoleum of Marshal Tito, who became the first President of Yugoslavia. Or enjoy a taste of the region by sampling Serbian plum brandy, Šljivovitz, and delicious local delights at the Quburich Distillery. For those wishing a more active adventure, join a guided bike tour. (B,L,D)

Day 5, SCENIC CRUISING THROUGH THE IRON GATES. The Iron Gates is one of Europe's most awe-inspiring natural wonders. The Danube narrows as it winds through a series of magnificent gorges between the Carpathian and Balkan mountains. The banks of the river dazzle with sheer-faced rocks that stretch high overhead along this natural border between Serbia and Romania. (B,L,D)

Day 6, VIDIN, . Explore Vidin, one of Bulgaria's oldest cities, and surrounding areas with a choice of excursions. Discover Baba Vida Fortress, the largest preserved medieval castle in Bulgaria overlooking the Danube. Continue on to Belogradchik, one of Bulgaria's natural



PELEȘ CASTLE, ROMANIA

GEMS OF SOUTHEAST EUROPE

wonders, where you can hike around its most spectacular rock formations. Alternatively, visit a local home for a demonstration of traditional Bulgarian yoghurt and Banitsa, a pastry you will also get to make. You also have the choice to bike through Vidin and to the castle. (B,L,D)

Day 7, ROUSSE – GIURGIU. Visit Bulgaria's ancient capital, Veliko Tarnovo, with its medieval fortress and multiple orthodox temples. You can opt instead to go to Rousse, known for its 19th- and 20th-century Neo-Baroque and Neo-Rococo architecture, and then afterwards visit the UNESCO-designated Rock-hewn Churches of Ivanovo with frescos revealing exceptional artistry of 14th-century paintings and Bulgarian medieval art. (B,L,D)

Day 8, DISEMBARKATION – GIURGIU. Disembark the ship in Giurgiu and prepare for your onward journey. (B)

OTHER ITINERARY OPTIONS

7-night cruise and 2 nights in Budapest at the Sofitel Chain Bridge Hotel

From an additional **£387** per person (added to the 7-night cruise price).
Single Supplement £213 per person

For more information, visit www.amawaterways.co.uk



EXPLORE LOCAL MARKETS

LAND PROGRAMME OPTIONS – PRE-CRUISE

VIENNA – 2 NIGHTS

Discover the culturally rich city of Vienna, savouring the Baroque elegance of this romantic city. A panoramic tour will guide you past the majestic Opera House, the former Imperial Palace of the Habsburg Emperors, Parliament, Town Hall and Vienna University. Afterwards, you will visit Vienna's historic city centre, a UNESCO World Heritage Site, and see St. Stephen's Cathedral, Graben and the world famous Spanish Riding School. Continue your journey with a sightseeing tour of Budapest where you will see the highlights of this beautiful city, set along the river banks. The tour will take in the famed Heroes' Square and Castle Hill, home to Fisherman's Bastion, Matthias Church and spectacular views of the Danube.

LAND PROGRAMME OPTIONS – POST-CRUISE

BRASOV & BUCHAREST – 3 NIGHTS

Journey through the Romanian countryside to Bran, where you'll visit Transylvania's legendary Bran Castle, which is forever linked with the legend of Dracula. Afterwards, travel to the lovely village of Braşov and enjoy a tour of the town, before staying overnight. En route to Bucharest, stop in Sinaia to visit Peleş Castle, Transylvania's other enchanting castle, considered by many to be one of the most stunning in Europe. Tour the castle, which was once the residence of the royal family. In Bucharest, Romania's capital, explore the "Little Paris of the East," with its wide boulevards and Arc de Triomphe. Enjoy a visit to the city's most impressive sites—including the historic city centre and the Palace of the Parliament, second only to the Pentagon as the largest administrative building in the world.

DATES AND FARES (£)

EMBARK DATE	START CITY	SHIP NAME	7-NIGHT CRUISE
Apr 14	Budapest	AmaCerto	£2,045
Apr 21	Giurgiu	AmaCerto	£2,178
May 12	Budapest	AmaCerto	£2,378
May 19	Giurgiu	AmaCerto	£2,378
Jun 09	Budapest	AmaCerto	£2,378
Jun 16	Giurgiu	AmaCerto	£2,378
Jul 21	Budapest	AmaCerto	£2,311
Jul 28	Giurgiu	AmaCerto	£2,311
Sep 15	Budapest	AmaCerto	£2,511
Sep 22	Giurgiu	AmaCerto	£2,511
Oct 13	Budapest	AmaCerto	£2,378
Oct 20	Giurgiu	AmaCerto	£2,245

Flights: Please call for fares and availability.

Transfers: Budapest Airport to Ship (or reverse): from £20 per person.

Ship to Bucharest Airport (or reverse): from £66 per person.

Cruise fares are per person based on double occupancy in a Cat. E, deluxe outside stateroom with window. To upgrade to a higher category, add per person:

CAT.	DECK	STATEROOM	ADD'L
D	Piano	Window	£199
C	Violin & Cello	French Balcony	£599
BB	Cello	French/Outside Balcony	£933
BA	Violin	French/Outside Balcony	£1,066
AB	Cello	French/Outside Balcony	£1,199
AA	Violin	French/Outside Balcony	£1,333
AA+	Violin	French/Outside Balcony	£1,733
Suite	Violin	French/Outside Balcony	£2,199

Port Charges: Fares include port charges of £112 per person

Single Supplement: Categories E – AA: add 50% per person; Categories AA+ and Suite: add 100% per person. Single supplement may be waived on D and E categories subject to availability. Please check at time of booking.

Bedding: Please select bedding configuration at the time of booking.

Option A: Two twin beds

Option B: One large bed (larger than queen size)

Deck Plans: AMACERTO – See page 166.

LAND PROGRAMMES

PRE-CRUISE – 2 NIGHTS VIENNA from £347 per person

POST-CRUISE – 3 NIGHTS ROMANIA (1 NIGHT BRASOV, 2 NIGHTS BUCHAREST) from £347 per person

Additional Hotel Nights (prices subject to change due to seasonality):

Prices are per person

Vienna: Double occupancy – £90, Single occupancy – £180

Budapest: Double occupancy – £87, Single occupancy – £174

Bucharest Double occupancy – £67, Single occupancy – £134

Upgrade to the Four Seasons in Budapest is available; ask for details.

Additional hotel nights include portage, breakfast, as well as transfers to/from the ship only in cities where the ship is embarking or disembarking.

Single Supplement: 2 Nights Vienna £213 per person

3 Nights Romania (1 Night Brasov, 2 Nights Bucharest) £320 per person

For more information on hotels, please see page 42.

THE MAIN, RHINE & MOSELLE RIVERS



EUROPE'S RIVERS & CASTLES

7 NIGHTS • NUREMBERG TO LUXEMBOURG CITY

TRAVEL FROM NUREMBERG, ALONG THE MAIN-DANUBE CANAL AND THROUGH THE RHINE GORGE TOWARDS LUXEMBOURG, ONE OF EUROPE'S LAST DUCHIES



Discover the three beautiful rivers, the Rhine, Main and Moselle, in one grand adventure. Cruise past historic vineyards and imposing hilltop castles. Discover how everything in Zell centres on the “Black Cat” and how it relates to wine, and learn the secrets of Trier’s Porta Nigra. Let the storybook villages of Rudesheim, Bernkastel and Cochem captivate you. All along the way, enjoy Europe at its most picturesque.



SHOP FOR LOCAL HANDICRAFTS



ZELL, GERMANY

DAILY PROGRAMME FEATURES

DAY	DESTINATION	ACTIVITIES
1	Nuremberg, Germany	✳ EMBARKATION
2	Bamberg, Schweinfurt, Germany	Walking tour and smoked beer tasting Free evening
3	Kitzingen, Würzburg, Germany	Walking tour and wine tasting City tour and Residenz Palace visit OR Kitzingen to Würzburg bike tour
4	Wertheim, Germany	Walking tour OR Main River bike tour OR Pretzel bakery visit and tasting OR Castle hike
5	Mainz, Germany	City tour with Chagall windows OR Full-day Heidelberg excursion OR Mainz to Rudesheim bike tour
	Rudesheim, Germany	Siegfried’s Mechanical Music Museum OR Vineyard hike OR Gondola ride
	Rhine Gorge, Koblenz, Germany	Scenic cruising Evening walking tour
6	Cochem, Germany	Reichsburg Castle and walking tour OR Cochem Mustard Mill tour OR Bike tour
	Zell, Germany	Exclusive wine festival
7	Trier, Germany	City tour OR Secrets of Porta Nigra tour OR Amphitheater Hill hike
8	Luxembourg City, Luxembourg	⚓ DISEMBARKATION

✳ Embark 7-Night Cruise

⚓ Disembark 7-Night Cruise

Note: Bike tours and hikes subject to weather and seasonality.

For full itinerary details, visit www.amawaterways.co.uk

INCLUDED FEATURES

- » 7 nights deluxe cruise accommodation in riverview stateroom or suite – most staterooms and suites offer French balconies
- » Entertainment-On-Demand in all staterooms featuring free high-speed internet access, movies, a music library and English language TV stations
- » Fine dining, including unlimited complimentary hand-selected wines, beer and soft drinks with lunch and dinner on board
- » Multiple dining venues, including The Chef's Table specialty restaurant featuring our unique tasting menu
- » **NEW FOR 2018 – Sip & Sail daily cocktail hour with complimentary wine, beer, spirits and soft drinks**
- » Welcome Cocktail, Welcome Dinner, La Chaîne des Rôtisseurs Dinner, Captain's Cocktail and Gala Dinner
- » Complimentary Wi-Fi access on board
- » Guided shore excursions in every port, including Special Interest Tours, hiking and biking tours
- » Onboard live entertainment, theme dinners, cooking demonstration and more
- » Complimentary bicycles, helmets and Nordic walking sticks
- » Services of a professionally trained Cruise Manager throughout your cruise and land stay
- » Transfers between hotel and ship are included with the purchase of cruise and land package

YOUR ITINERARY

Day 1, EMBARKATION – NUREMBERG, GERMANY.

Join your fellow travellers as you gather on board for a Welcome Dinner. The ship departs tonight for Bamberg. (D)

Day 2, BAMBERG – SCHWEINFURT. Discover enchanting Bamberg, a UNESCO World Heritage Site. Your guided walking tour includes the Imperial Cathedral and the charming fishermen's village known as "Little Venice" as well as taste the city's famous smoked beer, Rauchbier. (B,L,D)

Day 3, KITZINGEN – WÜRZBURG. Explore Kitzingen, Franconia's wine trade centre, with a city tour. Later, the Aulic (wine) Council and Wine Queen will welcome you with a special five-wine tasting in one of Germany's oldest wine cellars. During the afternoon, you have a choice of two excursions. Join a guided bike ride from Kitzingen to Würzburg along the Main River and "Romantic Road," or take a walking tour through Würzburg and then visit its Residenz Palace. The 300-room palace took nearly 60 years to complete and contains the world's largest ceiling fresco, created by Venetian painter Tiepolo, as well as one of the most beautiful staircases in the world (B,L,D)

Day 4, WERTHEIM. Wertheim's old town centre still features half-timbered houses and the Gothic architecture of the Stiftskirche, its oldest Protestant church. You may

either join a guided walking tour through the historic city centre or learn the art of pretzel making with a visit to a local bakery. For those seeking a more active adventure, take a scenic bike ride through the Main River Valley or hike high above the town for a visit to the castle, one of the most picturesque ruins in Germany. (B,L,D)

Day 5, MAINZ – RHINE GORGE – RÜDESHEIM – KOBLENZ. Arrive in Mainz, located at the confluence of the Main and Rhine rivers, where you have a choice of three excursions. Join a walking tour of Mainz, home to many historic treasures, including one of Germany's most important churches, the Romanesque cathedral and the Chagall stained-glass windows depicting scriptural scenes in stunning blue, which you will get to see. Alternatively, visit Heidelberg, Germany's oldest university town, where you will tour the Old Town and visit the red-walled castle with its Great Vat. For a more active adventure, cycle along the Rhine River to Rudesheim. During the afternoon, you can participate in one of three excursions while in Rudesheim. Visit Siegfried's Mechanical Music Museum, home to one of the greatest collections of self-playing musical instruments; take a ride over the vineyards of Rudesheim in a gondola to the Niederwald Monument; or go on a hike through the vineyards. Later in the day, set sail towards Koblenz through the Rhine



TOWN HALL, BAMBERG

EUROPE'S RIVERS & CASTLES

River Gorge, famous for its beautiful and imposing castles and legendary Lorelei Rock. After dinner, join a tour of Koblenz to explore its romantic narrow streets, historic squares and 12th-century churches. (B,L,D)

Day 6, COCHEM – ZELL. Wake up in fairytale Cochem and visit the Reichsburg Castle followed by a walking tour. As an alternative, visit one of Europe's oldest working mustard mills where you will sample Cochem's famous mustard. You may also opt to take a guided bike tour along the captivating Moselle River. Later cruise to Zell, famous for their Riesling and the well-known arched black cat icon, often seen on the labels of local German wines. Experience the hospitality of the citizens of Zell, including the local Wine Queen and Mayor, at an exclusive wine festival where you'll sample local wines, sausages and more. (B,L,D)

Day 7, ZELL – TRIER. Enjoy a scenic cruise along the Moselle to Trier, Germany's oldest city and a UNESCO World Heritage Site, renowned for its rich ancient Roman past. Join a guided tour of the city, including the old Roman amphitheatre, Roman Baths, Basilica of Constantine and the Porta Nigra Gate that dates back to 180 A.D. Alternatively, you can join a tour to discover the Secrets of the Porta Nigra; or go on a hike to Trier's amphitheatre where gladiators once held contests. (B,L,D)

Day 8, LUXEMBOURG – DISEMBARKATION. Disembark after breakfast and prepare for your journey home. (B)

LAND PROGRAMME OPTIONS – PRE-CRUISE

PRAGUE – 2 NIGHTS

Experience the wonders of Prague and its historic city centre that is a recognised UNESCO World Heritage Site. On your tour, you'll see Rudolfinum, the National Museum, Wenceslas Square and the Dancing House. Visit the 1,000 year-old Prague Castle and St. Vitus before walking over the romantic Charles Bridge to the Old Market Square. Depart Prague and drive through the pastoral German countryside for a city tour of Nuremberg's fabulous Gothic churches and impressive city walls before boarding your luxurious ship.

ENHANCED CRUISES AT NO ADDITIONAL COST



WINE CRUISES (see pages 34-39 for more information)
Add a unique, epicurean dimension to your itinerary.

Complimentary Bonus Features:

- ◆ Special tours and tastings at local wineries and private cellars
- ◆ Learn about winemaking in renowned vineyards
- ◆ Onboard wine pairings with award-winning cuisine
- ◆ A wine expert who leads tastings and discussions

Embark dates: 2018 - Apr 5, Jul 19

LAND PROGRAMME OPTIONS – POST-CRUISE

PARIS – 3 NIGHTS

Disembark in Luxembourg and stop at the American Cemetery and Memorial, the final resting place of General George Patton. You will enjoy a walking tour through Luxembourg before boarding a TGV high-speed train to Paris, where you will check into your hotel. Get acquainted with some of the many iconic sites in the "City of Light," including Notre Dame and the Eiffel Tower on a city tour. Visit famed landmarks; wander through one of Paris' priceless museums; linger in one of the city's many cafés; or shop on the Boulevard Haussmann.

DATES AND FARES (£)

EMBARK DATE	START CITY	SHIP NAME	7-NIGHT CRUISE
Apr 05	Nuremberg	AmaDante	£1,911
May 24	Nuremberg	AmaDante	£2,378
Jun 14	Nuremberg	AmaDante	£2,378
Jul 19	Nuremberg	AmaDante	£2,311
Aug 09	Nuremberg	AmaDante	£2,311
Aug 30	Nuremberg	AmaDante	£2,511
Sep 20	Nuremberg	AmaDante	£2,511
Oct 11	Nuremberg	AmaDante	£2,378
Nov 01	Nuremberg	AmaDante	£2,111

■ Wine Cruise; visit www.amawaterways.co.uk for detailed itinerary.

Flights: Please call for fares and availability.

Transfers: Nuremberg Airport to Ship: from £24 per person.

Ship (Wasserbillig) to Luxembourg Airport: from £30 per person.

Cruise fares are per person based on double occupancy in a Cat. E, deluxe outside stateroom with window. To upgrade to a higher category, add per person:

CAT.	DECK	STATEROOM	ADD'L
D	Piano	Window	£199
C	Violin & Cello	French Balcony	£599
B	Violin & Cello	French Balcony	£733
A	Violin	French Balcony	£799
A+	Violin	French Balcony	£1,466
Suite	Violin	French Balcony	£1,599

Port Charges: Fares include port charges of £112 per person

Single Supplement: Categories E – A: add 50% per person; Categories A+ and Suite: add 100% per person. Single supplement may be waived on D and E categories subject to availability. Please check at time of booking.

Bedding: Please select bedding configuration at the time of booking.

Option A: Two twin beds

Option B: One large bed (larger than queen size)

Deck Plans: AMADANTE – See pages 168.

LAND PROGRAMMES

PRE-CRUISE – 2 NIGHTS PRAGUE from £347 per person

POST-CRUISE – 3 NIGHTS PARIS from £880 per person

Additional Hotel Nights (prices subject to change due to seasonality):

Prices are per person

Prague: Double occupancy – £93, Single occupancy – £187

Paris: Double occupancy – £190, Single occupancy – £380

Nuremberg: Double occupancy – £123, Single occupancy – £247

Upgrade to the Four Seasons in Prague is available; ask for details.

Additional hotel nights include portage, breakfast, as well as transfers to/from the ship only in cities where the ship is embarking or disembarking.

Single Supplement:

2 Nights Prague £213 per person **3 Nights Paris** £320 per person

For more information on hotels, please see page 42.

THE RHINE & MAIN RIVERS



"LE PETIT FRANCE" DISTRICT, STRASBOURG

MEDIEVAL TREASURES

7-NIGHTS BASEL TO NUREMBERG

DISCOVER THE MANY MEDIEVAL TREASURES OF THE ROMANTIC RHINE ON THIS UNFORGETTABLE JOURNEY



Experience the romantic Rhine and peaceful Main rivers with their Ancient castles, grand palaces and medieval towns. Revel in the architectural gems on display—the Würzburg Residenz and Mannheim Baroque Palace. Visit the Alsatian capital of France, Strasbourg and discover many medieval treasures on this unforgettable journey.



CELEBRATE FRANCONIAN DELIGHTS



MILTENBERG, GERMANY

DAILY PROGRAMME FEATURES

DAY	DESTINATION	ACTIVITIES
1	Basel, Switzerland	✳️ EMBARKATION
2	Strasbourg, France	City tour OR Old Town bike tour
3	Ludwigshafen, Germany	Mannheim Baroque Palace OR Medieval Speyer OR Speyer Technical Museum
	Rüdesheim, Germany	Wine tasting
4	Rüdesheim	Gondola ride OR Siegfried's Mechanical Music Museum OR Rheingau bike ride OR Full-day Heidelberg excursion
	Frankfurt, Germany	Panoramic city tour and Römerberg beer tasting
5	Miltenberg, Germany	Walking tour OR Flavours of Miltenberg OR Bike tour
6	Würzburg, Germany	Walking tour OR Residenz Palace OR Marienberg Fortress hike Wine tasting
7	Bamberg, Germany	Walking tour and smoked beer tasting OR Bamberg bike tour OR Bamberg specialties tasting
8	Nuremberg, Germany	⚓ DISEMBARKATION

✳️ Embark 7-Night Cruise

⚓ Disembark 7-Night Cruise

Note: Bike tours and hikes subject to weather and seasonality.

For full itinerary details, visit www.amawaterways.co.uk

INCLUDED FEATURES

- » 7 nights deluxe cruise accommodation in riverview stateroom or suite – most staterooms and suites offer French balconies
- » Entertainment-On-Demand in all staterooms featuring free high-speed internet access, movies, a music library and English language TV stations
- » Fine dining, including unlimited complimentary hand-selected wines, beer and soft drinks with lunch and dinner on board
- » Multiple dining venues, including The Chef's Table specialty restaurant featuring our unique tasting menu
- » **NEW FOR 2018 – Sip & Sail daily cocktail hour with complimentary wine, beer, spirits and soft drinks**
- » Welcome Cocktail, Welcome Dinner, La Chaîne des Rôtisseurs Dinner, Captain's Cocktail and Gala Dinner
- » Complimentary Wi-Fi access on board
- » Guided shore excursions in every port, including Special Interest Tours, hiking and biking tours
- » Onboard live entertainment, theme dinners, cooking demonstration and more
- » Complimentary bicycles, helmets and Nordic walking sticks
- » Services of a professionally trained Cruise Manager throughout your cruise and land stay
- » Transfers between hotel and ship are included with the purchase of cruise and land package

YOUR ITINERARY

Day 1, EMBARKATION – BASEL, SWITZERLAND. Arrive in Basel and board your luxurious river cruise ship. Meet your fellow travellers tonight at the Welcome Dinner. (D)

Day 2, STRASBOURG. Join a tour of the city that takes you past the stunning Parc de l'Orangerie, the European Parliament and the Place de la République and then walk through the iconic “La Petite France” district, which appears to have been lifted straight from the pages of a fairytale. Wander through these charming streets and past the Cathédrale de Notre Dame with its famous astronomical clock. Alternatively, the active adventurer can go on a guided bike tour. (B,L,D)

Day 3, LUDWIGSHAFEN. Ludwigshafen is your gateway to a choice of three excursions. Visit the Mannheim Baroque Palace—one of the largest palaces in Europe. Alternatively, join a walking tour of one of Germany's oldest cities, Speyer, known for the largest Romanesque cathedral in Europe—a UNESCO World Heritage Site—and the medieval Altpörtel, Old Gate;

or visit the intriguing Speyer Technical Museum. Later in the day, sail to Rüdesheim, where you'll be treated to a Riesling wine tasting. (B,L,D)

Day 4, RÜDESHEIM – FRANKFURT. Continue your exploration of Rüdesheim with a choice of excursions. Those who fancy a more whimsical adventure will want to visit Siegfried's Mechanical Musical Instrument Museum, home to one of the greatest collections of self-playing musical instruments. For an adventure of a different kind, soar over the vineyards of Rüdesheim on a gondola to the Niederwald Monument; or opt to take a bike ride along the Rhine. You can also join a full-day excursion to Heidelberg, a perfectly preserved medieval city nestled in the Neckar River Valley along Germany's Castle Road. Later in the day, cruise to the metropolitan capital of Germany, Frankfurt, where you'll take in the sights on a panoramic city tour and then immerse yourself in the local flavours with an authentic Römerberg beer tasting. (B,L,D)



HEIDELBERG, GERMANY

MEDIEVAL TREASURES

Day 5, MILTENBERG. Enjoy a scenic cruise to Miltenberg, the “Pearl of the Main River.” While on your walking tour, you’ll discover why this medieval town seems to leap from the pages of a fairytale with its 14th- and 15th-century half-timbered, gabled houses; the famed Crooked House; and the venerable Royal Inn, which has been a working hotel since the 17th century. Alternatively, indulge in regional specialties of Franconia; or go on a guided bike ride along the Main River. (B,L,D)

Day 6, WÜRZBURG. Nestled along the “Romantic Road” in the middle of Germany’s largest wine producing region lies Würzburg. Join a walking tour of this beautiful city bursting with Baroque splendour. Or you can visit its crown jewel, the Baroque Residenz Palace, a UNESCO World Heritage Site that features an opulent interior, including a grand fresco by Tiepolo. Get more active with a hike up to the Marienberg Fortress, the most prominent landmark on the left bank of the Main River. During the afternoon, participate in a special Franconian wine tasting at the famous wine cellars located underneath Würzburg. (B,L,D)

Day 7, BAMBERG. Explore enchanting Bamberg, a UNESCO World Heritage Site, in one of three ways. Join a guided walking tour of this medieval gem to see its cathedral, Old Town Hall and elegant old mansions. Or taste your way through the city sampling smoked beer, licorice root and Hornla pastry, a local favourite whose recipe dates back to 1427. And for those wishing to explore the town more actively, hop on a bike for a guided bike tour along the Main River and to its quirky quarters beyond the town centre. (B,L,D)

Day 8, DISEMBARKATION – NUREMBERG. Disembark after breakfast and prepare for your journey home. (B)

LAND PROGRAMME OPTIONS – PRE-CRUISE

SWITZERLAND – 3 NIGHTS

Set alongside a glistening lake and framed by the Alps, Switzerland’s largest city, Zurich, seamlessly blends its historic past with its progressive future—all of which will be on full display during your city tour. See such places as Grossmünster Abbey, St. Peter and Old Town. Enjoy a scenic drive past Alpine lakes before reaching Vitznau. Upon arrival, enjoy a cruise across the tranquil waters of Lake Lucerne, surrounded by spectacular mountain scenery. Join a walking tour before visiting the Lion Monument and transferring to Basel to join your ship.

LAND PROGRAMME OPTIONS – POST-CRUISE

PRAGUE – 3 NIGHTS

Discover fairytale Prague via a city tour or a hike. Both will reveal why Prague is considered one of Europe’s most attractive and vibrant cities, with a historic city centre that’s recognised as a UNESCO World Heritage Site. See all the key highlights, including the National Museum, Wenceslas Square, the 1,000 year-old Prague Castle and Old Market Square, home to the Astronomical Clock. Wander through the city admiring its diversity of architectural styles: Gothic, Renaissance, Baroque, Rococo and Art Nouveau.



DATES AND FARES (£)

EMBARK DATE	START CITY	SHIP NAME	7-NIGHT CRUISE
May 17	Basel	AmaDante	£2,378
Jun 07	Basel	AmaDante	£2,378
Jul 12	Basel	AmaDante	£2,311
Aug 02	Basel	AmaDante	£2,311
Aug 23	Basel	AmaDante	£2,445
Sep 13	Basel	AmaDante	£2,511
Oct 04	Basel	AmaDante	£2,511
Oct 25	Basel	AmaDante	£2,178
Nov 15	Basel	AmaDante	£1,978

Flights: Please call for fares and availability.

Transfers: Basel Airport to Ship: from £40 per person.
Ship to Nuremberg Airport: from £24 per person.

Cruise fares are per person based on double occupancy in a Cat. E, deluxe outside stateroom with window. To upgrade to a higher category, add per person:

CAT.	DECK	STATEROOM	ADD'L
D	Piano	Window	£199
C	Violin & Cello	French Balcony	£599
B	Violin & Cello	French Balcony	£733
A	Violin	French Balcony	£799
A+	Violin	French Balcony	£1,466
S	Violin	French Balcony	£1,599

Port Charges: Fares include port charges of £112 per person

Single Supplement: Categories E – A: add 50% per person; Categories A+ and Suite: add 100% per person. Single supplement may be waived on D and E categories subject to availability. Please check at time of booking.

Bedding: Please select bedding configuration at the time of booking.
Option A: Two twin beds
Option B: One large bed (larger than queen size)

Deck Plans: AMADANTE – See pages 168.

LAND PROGRAMMES

PRE-CRUISE – 3 NIGHTS SWITZERLAND from £840 per person

POST-CRUISE – 3 NIGHTS PRAGUE from £520 per person

Additional Hotel Nights (prices subject to change due to seasonality):

Prices are per person

Zurich: Double occupancy – £154, Single occupancy – £307

Basel: Double occupancy – £223, Single occupancy – £467

Nuremberg: Double occupancy – £124, Single occupancy – £247

Prague: Double occupancy – £94, Single occupancy – £187

Upgrade to the Four Seasons in Prague is available; ask for details.

Additional hotel nights include portorage, breakfast, as well as transfers to/from the ship only in cities where the ship is embarking or disembarking.

Single Supplement:

3 Nights Switzerland £320 per person **3 Nights Prague** £320 per person

For more information on hotels, please see page 42.

THE RHINE RIVER



CAPTIVATING RHINE

7 NIGHTS • AMSTERDAM TO BASEL

TRAVEL FROM AMSTERDAM THROUGH THE PICTURESQUE RHINE VALLEY ENDING IN BASEL



The grand city of Amsterdam blends in perfect harmony its historic past and progressive future. Inspirational towns have given way to great stories, such as Heidelberg, where Mark Twain wrote “A Tramp Abroad.” Timeless traditions still remain intact—from the making of Cologne’s Kölsch beer to the making of Rudesheimer Coffee. Take a front-row seat on this enchanting journey along the Rhine to magnificent cities and charming villages alike.



HEIDELBERG CASTLE, GERMANY



AMSTERDAM, THE NETHERLANDS

DAILY PROGRAMME FEATURES

DAY	DESTINATION	ACTIVITIES
1	Amsterdam, The Netherlands	⚓ EMBARKATION
2	Amsterdam	Canal cruise and city tour Scenic cruising
3	Cologne, Germany	Walking tour and cathedral visit OR Cologne bike tour OR Kölsch beer tasting
4	Rhine Gorge Rudesheim, Germany	Scenic cruising Wine tasting OR Gondola ride OR Rheingau bike tour Siegfried’s Mechanical Music Museum OR Rudesheimer coffee
5	Mannheim, Germany	Heidelberg excursion OR Heidelberg Philosopher’s hike OR Medieval Speyer tour
6	Strasbourg, France	City tour OR Old Town bike tour
7	Breisach, Germany	Riquewih walking tour OR Freiburg excursion OR Breisach bike tour
8	Basel, Switzerland	⚓ DISEMBARKATION

⚓ Embark 7-Night Cruise

⚓ Disembark 7-Night Cruise

Note: Bike tours and hikes subject to weather and seasonality.

For full itinerary details, visit www.amawaterways.co.uk

INCLUDED FEATURES

- » 7 nights deluxe cruise accommodation in riverview stateroom or suite - most staterooms and suites offer twin balconies or French balconies
- » Entertainment-On-Demand in all staterooms featuring free high-speed internet access, movies, a music library and English language TV stations
- » Fine dining, including unlimited complimentary hand-selected wines, beer and soft drinks with lunch and dinner on board
- » Multiple dining venues, including The Chef's Table specialty restaurant featuring our unique tasting menu
- » **NEW FOR 2018 - Sip & Sail daily cocktail hour with complimentary wine, beer, spirits and soft drinks**
- » Welcome Cocktail, Welcome Dinner, La Chaîne des Rôtisseurs Dinner, Captain's Cocktail and Gala Dinner
- » Complimentary Wi-Fi access on board
- » Guided shore excursions in every port, including Special Interest Tours, hiking and biking tours
- » Onboard live entertainment, theme dinners, cooking demonstration and more
- » Complimentary bicycles, helmets and Nordic walking sticks
- » Services of a professionally trained Cruise Manager throughout your cruise and land stay
- » Transfers between hotel and ship are included with the purchase of cruise and land package

YOUR ITINERARY

Day 1, EMBARKATION - AMSTERDAM, THE NETHERLANDS. Arrive in Amsterdam and board your luxurious river cruise ship. (D)

Day 2, AMSTERDAM. Get acquainted with Amsterdam on a scenic canal cruise, where you will see the beautiful wooden Skinny Bridge and Anne Frank's House. Continue on with a walk to the Begijnhof and be charmed by its Middle Age buildings followed by a city tour that includes the Royal Palace and Westerkerk. Later in the day, enjoy scenic cruising. (B,L,D)

Day 3, COLOGNE - KOBLENZ. Enjoy cruising to Cologne, home to one of Germany's most revered Gothic masterpieces, the Cologne Cathedral. Join a guided tour through the enchanting Old Town and explore the UNESCO-designated cathedral, where the remains of the fabled Three Kings—the Magi—are believed to rest. Continue on and discover the Cologne Rathaus, Germany's oldest town hall, the Overstolzenhaus and the Festival Hall. Alternatively, ride a bike along the Rhine and through the historic Stadtpark. Or visit a local tavern to taste Cologne's traditional Kölsch beer and Reibekuchen—potato pancakes served with apple sauce. (B,L,D)

Day 4, RHINE GORGE - RÜDESHEIM. Cruise through the captivating UNESCO-designated Rhine Gorge, the most stunningly beautiful stretch of the river before reaching the winemaking town of Rüdesheim. Wine connoisseurs will want to go on a walking tour through the vineyards where you'll stop to sample wines at three different tasting stations. Or choose to drink up the stunning views by soaring high above the vineyards with a gondola ride to the Niederwalddenkmal Statue. For a more active adventure, join a guided bike tour along the scenic Rhine River. Later in the day, let Siegfried's Mechanical Music Museum charm you with its remarkable collection of self-playing musical instruments; or taste one of the town's special delights, Rüdesheimer Coffee, ceremoniously made with brandy, coffee and whipped cream. (B,L,D)

Day 5, MANNHEIM. You'll have a choice of three excursions. Visit Heidelberg, the perfectly preserved medieval city nestled in the Neckar River Valley along Germany's Castle Road. Discover the iconic red sandstone Heidelberg Castle and Great Vat, an 18th-century 49,000-gallon wine cask. For a more active adventure while in Heidelberg, join a guided hike up the Philosopher's Path, aptly named during the Romantic Period, and be rewarded

with panoramic views of the city. Alternatively, you can visit one of Germany's oldest cities, Speyer, known for the largest Romanesque cathedral in Europe—a UNESCO World Heritage Site—and the medieval Altpörtel, Old Gate. (B,L,D)

Day 6, STRASBOURG. Strasbourg, the capital city of Alsace, has flavours of both France and Germany because of its borderline location, which you'll get to discover. Enjoy a panoramic bus tour past the stunning Parc de l'Orangerie, the European Parliament and the Place de la République followed by a walking tour through its iconic "La Petite France" district, which appears to have been lifted straight from the pages of a fairytale. You'll also see the Cathédrale de Nôtre Dame with its famous astronomical clock. The active adventurer can join a guided bike tour, which also takes you through the Parc de l'Orangerie. (B,L,D)

Day 7, BREISACH. Step back in time with a visit to the enchanting Alsatian town of Riquewihr. Having survived WWII without being badly damaged, this charming medieval hamlet looks much like it did in the 16th century. On your walking tour, admire historic architecture and surrounding vineyards as well as famous sights, such as the Dolder Gate. Alternatively, you may wish to visit Freiburg, founded in 1120 and home to the Freiburg Münster, a Gothic cathedral said to have "the most beautiful spire on earth." Those wishing for a more active excursion can cycle through the countryside. (B,L,D)

Day 8, DISEMBARKATION - BASEL. Disembark after breakfast and prepare for your journey home. (B)



LAND PROGRAMME OPTIONS – PRE-CRUISE

AMSTERDAM – 2 NIGHTS

One of the world's most scenic cities and the country's capital, Amsterdam is the largest town in the Netherlands. From your arrival you will head to your hotel located in the heart of the city for two nights. This will act as the perfect base to discover the rich culture of one of Europe's most important port cities and marvel at its beautiful streets and canals as you explore at your own leisure before embarking your ship for your onward journey.

LAND PROGRAMME OPTIONS – POST-CRUISE

SWITZERLAND – 4 NIGHTS

Depart for Lucerne, where you will see the Lion Monument, followed by a walking tour. Discover this breathtaking city adorned with covered bridges, candy-coloured houses and a well-preserved medieval Old Town. A leisurely cruise will take you across the tranquil waters of Lake Lucerne to Vitznau, then a scenic drive through the countryside, passing Alpine lakes and small villages en route to Switzerland's largest city, Zurich. Seamlessly blending its historic past with its progressive future a city tour of the city will reveal Grossmünster Abbey; St. Peter, which boasts the world's largest church clock face; Old Town; Town Hall; and Fraumünster Abbey.

ENHANCED CRUISES AT NO ADDITIONAL COST

WINE CRUISES (see pages 34-39 for more information)
Add a unique, epicurean dimension to your itinerary.

Complimentary Bonus Features:

- ◆ Special tours and tastings at local wineries and private cellars
- ◆ Learn about winemaking in renowned vineyards
- ◆ Onboard wine pairings with award-winning cuisine
- ◆ A wine expert who leads tastings and discussions

Embark dates: 2018 - Mar 24, Mar 26, Apr 1, Aug 13, Nov 5, Nov 17

DATES AND FARES (£)

EMBARK DATE	START CITY	SHIP NAME	7-NIGHT CRUISE
Mar 24	Amsterdam	AmaPrima	£1,778
Mar 26	Amsterdam	AmaStella	£1,778
Apr 01	Amsterdam	AmaSonata	£1,911
Apr 09	Amsterdam	AmaStella	£1,978
Apr 15	Amsterdam	AmaSonata	£2,111
Apr 23	Amsterdam	AmaStella	£2,245
Apr 26	Amsterdam	AmaDante	£2,245
Apr 29	Amsterdam	AmaSonata	£2,245
Apr 30	Amsterdam	AmaKristina	£2,245
May 05	Amsterdam	AmaPrima	£2,311
May 07	Amsterdam	AmaStella	£2,311
May 13	Amsterdam	AmaSonata	£2,378
May 14	Amsterdam	AmaKristina	£2,378
May 21	Amsterdam	AmaStella	£2,378
May 28	Amsterdam	AmaKristina	£2,378
Jun 04	Amsterdam	AmaStella	£2,378
Jun 11	Amsterdam	AmaKristina	£2,378
Jun 18	Amsterdam	AmaStella	£2,378
Jun 25	Amsterdam	AmaKristina	£2,378
Jul 02	Amsterdam	AmaStella	£2,311
Jul 09	Amsterdam	AmaKristina	£2,311
Jul 16	Amsterdam	AmaStella	£2,311
Jul 23	Amsterdam	AmaKristina	£2,311
Jul 30	Amsterdam	AmaStella	£2,311
Aug 06	Amsterdam	AmaKristina	£2,311
Aug 13	Amsterdam	AmaStella	£2,311
Aug 20	Amsterdam	AmaKristina	£2,445
Aug 27	Amsterdam	AmaStella	£2,445
Sep 03	Amsterdam	AmaKristina	£2,511
Sep 10	Amsterdam	AmaStella	£2,511
Sep 15	Amsterdam	AmaPrima	£2,511
Sep 17	Amsterdam	AmaKristina	£2,511
Sep 24	Amsterdam	AmaStella	£2,511
Sep 29	Amsterdam	AmaPrima	£2,511
Oct 01	Amsterdam	AmaKristina	£2,511
Oct 08	Amsterdam	AmaStella	£2,445
Oct 15	Amsterdam	AmaKristina	£2,311
Oct 22	Amsterdam	AmaStella	£2,245
Oct 29	Amsterdam	AmaKristina	£2,178
Nov 03	Amsterdam	AmaPrima	£2,111
Nov 05	Amsterdam	AmaStella	£2,045
Nov 12	Amsterdam	AmaKristina	£1,978
Nov 17	Amsterdam	AmaPrima	£1,978
Nov 19	Amsterdam	AmaStella	£1,978

■ Wine Cruise; visit www.amawaterways.co.uk for detailed itinerary.

Note: Excursions to the Keukenhof Gardens may be available on sailings from late March through early May.

Flights: Please call for fares and availability.
Transfers: Amsterdam Airport to Ship: from £20 per person.
Ship to Basel Airport: from £40 per person.

Cruise fares are per person based on double occupancy in a Cat. E, deluxe outside stateroom with window. To upgrade to a higher category, add per person:

AMAKRISTINA, AMAPRIMA, AMASONATA & AMASTELLA

CAT.	DECK	STATEROOM	ADD'L
D	Piano	Window	£199
CB	Violin	French Balcony	£399
CA/C	Violin & Cello	French Balcony	£599
BB	Cello	French/Outside Balcony	£933
BA	Violin	French/Outside Balcony	£1,066
AB	Cello	French/Outside Balcony	£1,199
AA	Violin	French/Outside Balcony	£1,333
AA+	Violin	French/Outside Balcony	£1,733
Suite	Violin	French/Outside Balcony	£2,199

AMADANTE

CAT.	DECK	STATEROOM	ADD'L
D	Piano	Window	£199
C	Violin & Cello	French Balcony	£599
B	Violin & Cello	French Balcony	£733
A	Violin	French Balcony	£799
A+	Violin	French Balcony	£1,466
Suite	Violin	French Balcony	£1,599

Port Charges: Fares include port charges of £112 per person

Single Supplement: Categories E – A, AA: add 50% per person; Categories A+, AA+ and Suite: add 100% per person. Single supplement may be waived on D and E categories subject to availability. Please check at time of booking.

Bedding: Please select bedding configuration at the time of booking.
Option A: Two twin beds
Option B: One large bed (larger than queen size)

Deck Plans: AMAKRISTINA & AMASTELLA – See page 164.

AMAPRIMA & AMASONATA – See page 166.

AMADANTE – See page 168.

LAND PROGRAMMES

PRE CRUISE – 2 NIGHTS AMSTERDAM from £327 per person

POST CRUISE – 4 NIGHTS SWITZERLAND from £1,120 per person

Additional Hotel Nights (prices subject to change due to seasonality):

Prices are per person
Amsterdam: Double occupancy – £180, Single occupancy – £360
Zurich: Double occupancy – £154, Single occupancy – £307
Basel: Double occupancy – £234, Single occupancy – £467

Additional hotel nights include portage, breakfast, as well as transfers to/from the ship only in cities where the ship is embarking or disembarking.

Single Supplement:
2 Nights Amsterdam £327 per person **4 Nights Switzerland** £427 per person

For more information on hotels, please see page 42.

THE RHINE RIVER



ENCHANTING RHINE

7 NIGHTS • BASEL TO AMSTERDAM

TRAVEL FROM BASEL THROUGH THE PICTURESQUE RHINE VALLEY ENDING IN AMSTERDAM



Contoured by vineyard-clad hills and castles from yesteryear, the legendary Rhine captivates. Experience the allure of France's Alsace region in its welcoming capital, Strasbourg, and its priceless gem, Riquewihr. Fabled towns lost in time present you with the chance to taste local flavours—Rudesheimer coffee and Kölsch beer—and to touch history up close with guided hikes and bike rides. From Amsterdam's colourful canals to the majestic Swiss Alps, journey into the heart of the destinations you visit.



AMAZING SIGHTS AWAIT



HEIDELBERG, GERMANY

DAILY PROGRAMME FEATURES

DAY	DESTINATION	ACTIVITIES
1	Basel, Switzerland	✳️ EMBARKATION
2	Breisach, Germany	Riquewihr excursion OR Freiburg excursion OR Breisach bike tour
3	Strasbourg, France	City tour OR Old Town bike tour
4	Mannheim, Germany	Heidelberg excursion OR Heidelberg Philosopher's hike OR Medieval Speyer excursion
	Rudesheim, Germany	Siegfried's Mechanical Music Museum OR Rudesheimer coffee
5	Rudesheim	Gondola ride and wine tasting OR Rheingau bike tour OR Ehrenfel's Castle hike
	Rhine Gorge, Koblenz, Germany	Scenic cruise Evening walk
6	Cologne, Germany	Walking tour and cathedral visit OR Kölsch Beer tasting OR Cologne bike tour
7	Amsterdam, The Netherlands	Canal cruise and city tour OR Jordaan District walking tour OR Jewish Heritage tour
8	Amsterdam	⤴️ DISEMBARKATION

✳️ Embark 7-Night Cruise

⤴️ Disembark 7-Night Cruise

Note: After October, there are no stops in Koblenz. Bike tours and hikes subject to weather and seasonality.

For full itinerary details, visit www.amawaterways.co.uk

INCLUDED FEATURES

- » 7 nights deluxe cruise accommodation in riverview stateroom or suite – most staterooms and suites offer twin balconies or French balconies
- » Entertainment-On-Demand in all staterooms featuring free high-speed internet access, movies, a music library and English language TV stations
- » Fine dining, including unlimited complimentary hand-selected wines, beer and soft drinks with lunch and dinner on board
- » Multiple dining venues, including The Chef's Table specialty restaurant featuring our unique tasting menu
- » **NEW FOR 2018 – Sip & Sail daily cocktail hour with complimentary wine, beer, spirits and soft drinks**
- » Welcome Cocktail, Welcome Dinner, La Chaîne des Rôtisseurs Dinner, Captain's Cocktail and Gala Dinner
- » Complimentary Wi-Fi access on board
- » Guided shore excursions in every port, including Special Interest Tours, hiking and biking tours
- » Onboard live entertainment, theme dinners, cooking demonstration and more
- » Complimentary bicycles, helmets and Nordic walking sticks
- » Services of a professionally trained Cruise Manager throughout your cruise and land stay
- » Transfers between hotel and ship are included with the purchase of cruise and land package

YOUR ITINERARY

Day 1, EMBARKATION – BASEL, SWITZERLAND. Arrive in Basel and board your luxurious river cruise ship. Meet your fellow travellers tonight at the Welcome Dinner. (D)

Day 2, BREISACH. Step back in time with a visit to the enchanting Alsatian town of Riquewihr, which looks almost the same as it did in the 16th century. On your walking tour, admire historic architecture as well as famous sights, such as the Dolder Gate. Alternatively, you may wish to go to Freiburg, founded in 1120 and home to the Freiburg's Münster, a Gothic cathedral said to have "the most beautiful spire on earth." Those wishing a more active excursion can cycle through the countryside. (B,L,D)

Day 3, STRASBOURG. One of the most enchanting cities in Europe and home to the UNESCO World Heritage Site, The Grand Ile, Strasbourg will captivate you. Discover its many treasures with a panoramic tour past the stunning Parc de l'Orangerie, the European Parliament and the Place de la République. You'll then walk through its iconic "La Petite France" district, which appears to have been lifted straight from the pages of a fairytale. Prefer to enjoy the city more actively, then join a guided bike tour, which also takes you through the Parc de l'Orangerie. (B,L,D)

Day 4, MANNHEIM – RÜDESHEIM. You'll have a choice of three excursions. Visit Heidelberg, the perfectly preserved medieval city nestled in the Neckar River Valley along Germany's Castle Road. Discover the iconic red sandstone Heidelberg Castle and Great Vat, an 18th-century 49,000-gallon wine cask. For a more active adventure while in Heidelberg, join a guided hike up the Philosopher's Path and be rewarded with panoramic views of the city. Alternatively, you can visit one of Germany's oldest cities, Speyer, known for the largest Romanesque cathedral in Europe—a UNESCO World Heritage Site—and the medieval Altpörtel, Old Gate. Later in the day, set sail to Rudesheim, where you'll have the opportunity to visit Siegfried's Mechanical Musical Instrument Museum or enjoy a tasting of Rudesheimer coffee, ceremoniously made with brandy. (B,L,D)

Day 5, RÜDESHEIM – RHINE GORGE – KOBLENZ. Spend the morning in Rudesheim and enjoy a tasting of Riesling wines after a lovely gondola ride soaring high above the vineyards en route to the Niederwalddenkmal Statue. Alternatively, opt for a hike that takes you through the vineyards to Ehrenfels Castle, where you can enjoy stunning views of the Rhine. A third choice is cycling

along the Rhine and through this scenic town. Later in the day, the ship sails through the enchanting UNESCO-designated Rhine Gorge, the most stunningly beautiful stretch of the river before reaching Koblenz, where you will enjoy a guided walk through the lovely Old Town. (B,L,D)

Day 6, KOBLENZ – COLOGNE. Home to one of Germany's most revered Gothic masterpieces, the Cologne Cathedral, this 2,000 year-old city is also a bustling cosmopolitan hotspot. Join a guided tour through the enchanting Old Town and explore the UNESCO-designated cathedral, where the remains of the fabled Three Kings—the Magi—are believed to rest. Alternatively, ride a bike along the Rhine and through the historic Stadtgarten. Or visit a local tavern to taste Kölsch beer and Reibekuchen—potato pancakes served with apple sauce. (B,L,D)

Day 7, AMSTERDAM. Eclectic Amsterdam boasts amazing history, art, architecture, and museums, and you have three choices as to how you wish to explore it. The famous canals of Amsterdam await discovery on your city tour beginning with a scenic canal cruise followed by a walk to Begijnhof, known for its Middle Age buildings. For a different view of the city, you can join the Jordaan



LUCERNE, SWITZERLAND

ENCHANTING RHINE

District walking tour or the Jewish Heritage tour. The Jordaan District tour begins at the Westerchurch and takes you past the Noordermarkt, the Karthuizerhof and the "9 streets"; afterwards, you'll stop in a local café for a hot beverage and Dutch apple pie. The Jewish Heritage tour begins with a visit to the 17th-century Portuguese Synagogue and the Jewish Historical Museum chronicling the history of the Jews in Amsterdam. (B,L,D)

Day 8, DISEMBARKATION - AMSTERDAM. Bid Farewell to Amsterdam as you prepare for your flight home. (B)

LAND PROGRAMME OPTIONS – PRE-CRUISE

SWITZERLAND - 4 NIGHTS

Switzerland's largest city, Zurich, seamlessly blends its historic past with its progressive future, which comes to life on your city tour. See Grossmünster Abbey; St. Peter, which boasts the world's largest church clock face; Old Town and Town Hall. Depart Zurich for a scenic drive to Vitznau on Lake Lucerne. Admire the spectacular scenery during a lake cruise that takes you to Lucerne. Explore the city's well-preserved Old Town with its candy-coloured houses, architectural treasures and ancient covered wooden bridge and discover the iconic Lion Monument before transferring to Basel where you will embark your ship.

LAND PROGRAMME OPTIONS – POST-CRUISE

AMSTERDAM - 2 NIGHTS

One of the world's most scenic cities and the country's capital, Amsterdam is the largest town in the Netherlands. From disembarkation you will head to your hotel located in the heart of the city for two nights. This will act as the perfect base to discover the rich culture of one of Europe's most important port cities and marvel at its beautiful streets and canals as you explore at your own leisure before preparing for your onward journey.

DATES AND FARES (£)

EMBARK DATE	START CITY	SHIP NAME	7-NIGHT CRUISE
Mar 31	Basel	AmaPrima	£1,845
Apr 02	Basel	AmaStella	£1,911
Apr 08	Basel	AmaSonata	£1,978
Apr 16	Basel	AmaStella	£2,111
Apr 19	Basel	AmaDante	£2,111
Apr 22	Basel	AmaSonata	£2,178
Apr 30	Basel	AmaStella	£2,245
May 06	Basel	AmaSonata	£2,311
May 07	Basel	AmaKristina	£2,311
May 12	Basel	AmaPrima	£2,378
May 14	Basel	AmaStella	£2,378
May 20	Basel	AmaSonata	£2,378
May 21	Basel	AmaKristina	£2,378
May 28	Basel	AmaStella	£2,378
Jun 04	Basel	AmaKristina	£2,378
Jul 30	Basel	AmaKristina	£2,311
Aug 06	Basel	AmaStella	£2,311
Aug 13	Basel	AmaKristina	£2,311
Aug 20	Basel	AmaStella	£2,445
Aug 27	Basel	AmaKristina	£2,445
Sep 03	Basel	AmaStella	£2,511
Sep 10	Basel	AmaKristina	£2,511
Sep 17	Basel	AmaStella	£2,511
Sep 22	Basel	AmaPrima	£2,511
Sep 24	Basel	AmaKristina	£2,511
Oct 01	Basel	AmaStella	£2,511
Oct 06	Basel	AmaPrima	£2,445
Oct 08	Basel	AmaKristina	£2,445
Oct 15	Basel	AmaStella	£2,311
Oct 22	Basel	AmaKristina	£2,245
Oct 29	Basel	AmaStella	£2,178
Nov 05	Basel	AmaKristina	£2,045
Nov 10	Basel	AmaPrima	£1,978
Nov 12	Basel	AmaStella	£1,978
Nov 19	Basel	AmaKristina	£1,978

■ Wine Cruise; visit www.amawaterways.co.uk for detailed itinerary.

Note: Excursions to the Keukenof Gardens may be available on sailings from late March through early May.

Flights: Please call for fares and availability.

Transfers: Basel Airport to Ship: from £40 per person.
Ship to Amsterdam Airport: from £20 per person

Cruise fares are per person based on double occupancy in a Cat. E, deluxe outside stateroom with window. To upgrade to a higher category, add per person:

AMAKRISTINA, AMAPRIMA, AMASONATA & AMASTELLA

CAT.	DECK	STATEROOM	ADD'L
D	Piano	Window	£199
CB	Violin	French Balcony	£599
CA/C	Violin & Cello	French Balcony	£599
BB	Cello	French/Outside Balcony	£933
BA	Violin	French/Outside Balcony	£1,066
AB	Cello	French/Outside Balcony	£1,199
AA	Violin	French/Outside Balcony	£1,333
AA+	Violin	French/Outside Balcony	£1,733
Suite	Violin	French/Outside Balcony	£2,199

AMADANTE

CAT.	DECK	STATEROOM	ADD'L
D	Piano	Window	£199
C	Violin & Cello	French Balcony	£599
B	Violin & Cello	French Balcony	£733
A	Violin	French Balcony	£799
A+	Violin	French Balcony	£1,466
Suite	Violin	French Balcony	£1,599

Port Charges: Fares include port charges of £112 per person

Single Supplement: Categories E - A, AA: add 50% per person; Categories A+, AA+ and Suite: add 100% per person. Single supplement may be waived on D and E categories subject to availability. Please check at time of booking.

Bedding: Please select bedding configuration at the time of booking.

Option A: Two twin beds

Option B: One large bed (larger than queen size)

Deck Plans: AMAKRISTINA & AMASTELLA - See page 164

AMASONATA & AMAPRIMA - See page 166

AMADANTE - See page 168

LAND PROGRAMMES

PRE-CRUISE - 4 NIGHTS SWITZERLAND from £1,120 per person

POST-CRUISE - 2 NIGHTS AMSTERDAM from £327 per person

Additional Hotel Nights (prices subject to change due to seasonality):

Prices are per person

Zurich: Double occupancy - £154, Single occupancy - £307

Basel: Double occupancy - £234, Single occupancy - £467

Amsterdam: Double occupancy - £180, Single occupancy - £360

Additional hotel nights include portage, breakfast, as well as transfers to/from the ship only in cities where the ship is embarking or disembarking.

Single Supplement:

4 Nights Switzerland £427 per person **2 Nights Amsterdam** £327 per person

For more information on hotels, please see page 42.

ENHANCED CRUISES AT NO ADDITIONAL COST



WINE CRUISES (see pages 34-39 for more information)

Add a unique, epicurean dimension to your itinerary.

Complimentary Bonus Features:

- ◆ Special tours and tastings at local wineries and private cellars
- ◆ Learn about winemaking in renowned vineyards
- ◆ Onboard wine pairings with award-winning cuisine
- ◆ A wine expert who leads tastings and discussions

Embark dates: 2018 - Mar 31, Apr 2, Apr 8, Nov 5, Nov 12, Nov 19

THE RHINE & MOSELLE RIVERS



RHINE & MOSELLE SPLENDOURS

7 NIGHTS • LUXEMBOURG TO BASEL

EXPAND YOUR IMAGINATION IN FAIRYTALE VILLAGES ALONG TWO OF EUROPE'S MOST CAPTIVATING RIVERS



Journey along the Rhine and Moselle rivers, expanding your imagination in fairytale villages, such as Cochem, Bernkastel and Riquewihr. Where folklore and history come alive in every street, whimsical fantasies also come to life at Siegfried's Mechanical Museum and at Schwetzingen Gardens. Encounter fascinating Roman ruins, medieval towns with colourful half-timbered houses and enchanting castles as you cruise along two of Europe's most captivating rivers.



EHRENFELS CASTLE



CAPTURE MEMORABLE MOMENTS

DAILY PROGRAMME FEATURES

DAY	DESTINATION	ACTIVITIES
1	Luxembourg City, Luxembourg	✦ EMBARKATION
2	Trier, Germany Bernkastel, Germany	City tour Walking tour and wine tasting
3	Cochem, Germany	Reichsburg Castle and walking tour OR Reichsburg Castle hike OR Bundesbank Bunker tour
	Moselle Koblenz, Germany	Scenic cruising Walking tour
4	Rhine Gorge Rudesheim, Germany	Scenic cruising Gondola ride and wine tasting OR Ehrenfels Castle hike OR Rheingau bike tour Siegfried's Mechanical Music Museum OR Rudesheimer Coffee
5	Ludwigshafen, Germany	Heidelberg excursion OR Mannheim Baroque Palace OR Schwetzingen Gardens
6	Strasbourg, France	City tour OR Old Town bike tour
7	Breisach, Germany	Riquewihr walking tour OR Freiburg excursion OR Breisach bike tour
	Basel, Switzerland	Free evening
8	Basel	⚓ DISEMBARKATION

✦ Embark 7-Night Cruise

⚓ Disembark 7-Night Cruise

Note: Bike tours and hikes subject to weather and seasonality.

For full itinerary details, visit www.amawaterways.co.uk

INCLUDED FEATURES

- » 7 nights deluxe cruise accommodation in riverview stateroom or suite – most staterooms and suites offer French balconies
- » Entertainment-On-Demand in all staterooms featuring free high-speed internet access, movies, a music library and English language TV stations
- » Fine dining, including unlimited complimentary hand-selected wines, beer and soft drinks with lunch and dinner on board
- » Multiple dining venues, including The Chef's Table specialty restaurant featuring our unique tasting menu
- » **NEW FOR 2018 – Sip & Sail daily cocktail hour with complimentary wine, beer, spirits and soft drinks**
- » Welcome Cocktail, Welcome Dinner, La Chaîne des Rôtisseurs Dinner, Captain's Cocktail and Gala Dinner
- » Complimentary Wi-Fi access on board
- » Guided shore excursions in every port, including Special Interest Tours, hiking and biking tours
- » Onboard live entertainment, theme dinners, cooking demonstration and more
- » Complimentary bicycles, helmets and Nordic walking sticks
- » Services of a professionally trained Cruise Manager throughout your cruise and land stay
- » Transfers between hotel and ship are included with the purchase of cruise and land package

YOUR ITINERARY

Day 1, EMBARKATION – LUXEMBOURG CITY, LUXEMBOURG. Arrive in Luxembourg City, capital of one of Europe's last duchies, and board your luxurious ship. Meet your fellow travellers at the Welcome Dinner. (D)

Day 2, TRIER – BERNKASTEL. Trier, Germany's oldest city, has often been referred to as the second Rome. Be guided to the Roman Imperial Baths, the Porta Nigra and Emperor Constantine's Throne Room. During the afternoon, sail the Moselle River to Bernkastel, strategically located in the middle of the Moselle Valley's wine-producing region. Walk through the colourful Old Town centre and past many medieval buildings before enjoying a wine tasting at a local winery. (B,L,D)

Day 3, COCHEM – KOBLENZ. History comes to life in Cochem with its half-timbered houses and Reichsburg Castle. Join a guided tour through the castle, situated high above the town, and then walk through its Old Town. For those wishing to have a more active exploration of the area, you can go on a guided hike to the castle. Or for a different adventure, explore the Bundesbank Bunker to get a closer look at this mysterious Cold War era bank vault. Later in the day, sail along the Moselle taking in the fascinating scenery of Europe's steepest vineyards before

arriving in Koblenz where you can enjoy an evening walk through its picturesque Old Town. (B,L,D)

Day 4, KOBLENZ – RHINE GORGE – RÜDESHEIM. Cruise along the scenic Rhine River Gorge with its fabled legends and many castles dotting high above its riverbank. Once in Rudesheim, you will have three choices of excursions. Take a gondola ride to the Niederwalddenkmal Statue, where you can enjoy panoramic views of the river. Afterwards, indulge your taste buds with a sampling of Riesling wines in the vineyards. Alternatively, you can join a guided bike tour through the town and along the Rhine River; or hike to Ehrenfels Castle, idyllically situated in the midst of the vineyards. Later in the day, you have two more excursions. Visit Siegfried's Mechanical Music Museum or taste one of the town's special delights, Rudesheimer coffee, ceremoniously made with brandy. (B,L,D)

Day 5, LUDWIGSHAFEN. Discover a grand Baroque palace, one of Mark Twain's favourite European towns or one of the most whimsical gardens in the Europe on choice of excursions. Relive a bygone era on an excursion to the glorious Mannheim Baroque Palace. Tour this splendid palace furnished with over 800 exhibits,



HEIDELBERG, GERMANY

RHINE & MOSELLE SPLENDOURS

including 21 large tapestries, ornate furniture, priceless paintings, valuable porcelain and costly silverware. Prefer to visit the town Mark Twain fell in love with, then join on a tour to Heidelberg, a perfectly preserved medieval city nestled in the Neckar River Valley along Germany's Castle Road. You'll see the red-walled castle with its Great Vat, an 18th-century 49,000-gallon wine cask and the old city. Alternatively, visit Schwetzingen Palace Gardens, a cultural heritage site of European significance. Wander through the gardens with more than 100 sculptures and admire an assortment of whimsical buildings. The Apollotempel, houses a statue of the ancient Greek god of light and the arts, playing the lyre; the Badehaus, a summerhouse modelled on an Italian villa; and the most spectacular, the Türkischer Garten with a mosque designed by Nicolas de Pigage, the largest structure of its kind in a German garden—are a few of the many highlights you will see. (B,L,D)

Day 6, STRASBOURG. Strasbourg, the capital city of Alsace, has flavours of both France and Germany because of its borderline location, which you'll get to discover. Enjoy a panoramic bus tour past the stunning Parc de l'Orangerie, the European Parliament and the Place de la République followed by a walking tour through its iconic "La Petite France" district, which appears to have been lifted straight from the pages of a fairytale. You'll also see the Cathédrale de Notre Dame with its famous astronomical clock. The active adventurer can join a guided Old Town bike tour, which also takes you through the Parc de l'Orangerie. (B,L,D)

LAND PROGRAMME OPTIONS – PRE-CRUISE

PARIS – 3 NIGHTS

From morning to night, the "City of Light" dazzles. Get acquainted with Paris and some of its many iconic sites, including Notre Dame and the Eiffel Tower on a city tour. Bid au revoir as you board your TGV high-speed train that will whisk you away to Luxembourg, one of Europe's last independent duchies. Enjoy a guided walking tour as well as a stop at the American Cemetery and Memorial, the final resting place of General George Patton, before boarding your luxury ship.

Day 7, BREISACH – BASE. Step back in time with a visit to Riquewihr, a charming medieval hamlet that looks almost the same as it did in the 16th century. On your walking tour, admire historic architecture and surrounding vineyards as well as famous sights, such as the Dolder Gate. Alternatively, you may wish to go to Freiburg, founded in 1120 and home to the Freiburg's Münster, a Gothic cathedral said to have "the most beautiful spire on earth." Those wishing a more active excursion can cycle through the scenic countryside. Later in the day, sail to Basel where you will have leisure time to explore the city. (B,L,D)

Day 8, DISEMBARKATION – BASEL. Disembark after breakfast and prepare for your journey home. (B)

LAND PROGRAMME OPTIONS – POST-CRUISE

SWITZERLAND – 3 NIGHTS

Disembark the ship and depart for Zurich. En route, stop in Lucerne where you will visit the Lion Monument and take a walking tour before enjoying a leisurely cruise across the tranquil waters of Lake Lucerne to Vitznau. Here you will enjoy a scenic drive through the countryside, before arriving in Zurich. Set alongside a gleaming lake and framed by the Alps, Switzerland's largest city, Zurich, seamlessly blends its historic past with its progressive future—all of which will be on full display during your city tour. See Grossmünster Abbey; St. Peter, which boasts the world's largest church clock face; Old Town; Town Hall; and Fraumünster Abbey.

ENHANCED CRUISES AT NO ADDITIONAL COST

WINE CRUISES (see pages 34-39 for more information)

Add a unique, epicurean dimension to your itinerary.

Complimentary Bonus Features:

- ◆ Special tours and tastings at local wineries and private cellars

DATES AND FARES (£)

EMBARK DATE	START CITY	SHIP NAME	7-NIGHT CRUISE
Apr 12	Luxembourg	AmaDante	£2,045
May 31	Luxembourg	AmaDante	£2,378
Jun 21	Luxembourg	AmaDante	£2,378
Jul 26	Luxembourg	AmaDante	£2,311
Aug 16	Luxembourg	AmaDante	£2,378
Sep 06	Luxembourg	AmaDante	£2,511
Sep 27	Luxembourg	AmaDante	£2,511
Oct 18	Luxembourg	AmaDante	£2,311
Nov 08	Luxembourg	AmaDante	£2,045

◆ Wine Cruise; visit www.amawaterways.co.uk for detailed itinerary.

Flights: Please call for fares and availability.

Transfers: Luxembourg Airport to Ship (Wasserbilig): from £30 per person. Basel Airport to Ship: from £40 per person.

Cruise fares are per person based on double occupancy in a Cat. E, deluxe outside stateroom with window. To upgrade to a higher category, add per person:

CAT.	DECK	STATEROOM	ADD'L
D	Piano	Window	£199
C	Violin & Cello	French Balcony	£599
B	Violin & Cello	French Balcony	£733
A	Violin	French Balcony	£799
A+	Violin	French Balcony	£1,466
Suite	Violin	French Balcony	£1,599

Port Charges: Fares include port charges of £112 per person

Single Supplement: Categories E – A add 50% per person; Categories A+ and Suite: add 100% per person. Single supplement may be waived on D and E categories subject to availability. Please check at time of booking.

Bedding: Please select bedding configuration at the time of booking. Option A: Two twin beds. Option B: One large bed (larger than queen size)

Deck Plans: AMADANTE – See page 168

LAND PROGRAMMES

PRE-CRUISE – 3 NIGHTS PARIS from £880 per person

POST-CRUISE – 3 NIGHTS SWITZERLAND from £840 per person

Additional Hotel Nights (prices subject to change due to seasonality):

Prices are per person

Paris: Double occupancy – £190, Single occupancy – £380

Basel: Double occupancy – £234, Single occupancy – £467

Zurich: Double occupancy – £154, Single occupancy – £307

Additional hotel nights include portage, breakfast, as well as transfers to/from the ship only in cities where the ship is embarking or disembarking.

Single Supplement:

3 Nights Paris £320 per person **3 Nights Switzerland** £320 per person

For more information on hotels, please see page 42.

- ◆ Learn about winemaking in renowned vineyards
- ◆ Onboard wine pairings with award-winning cuisine
- ◆ A wine expert who leads tastings and discussions

Embark dates: 2018 - Apr 12, Nov 8

THE RHINE & MOSELLE RIVERS



RHINE & MOSELLE DELIGHTS

10 NIGHTS • BASEL TO AMSTERDAM

DRAMATIC RIVERS YIELD TO FAIRYTALE TOWNS AND ICONIC CITIES ALL COME ALIVE AS YOU DISCOVER THE STORIED RHINE AND MOSELLE



Dramatic rivers yielding to fairytale towns and iconic cities all come alive as you discover four countries along the storied Rhine and Moselle. From the colourful canals of Amsterdam to the quaint beauty of Rudesheim, delve into history, legends and culture. Throughout your journey, wander through postcard-perfect towns, let your inner adventurer out as you hike through vineyards and bike along rivers, and be enchanted by fairytale castles and a plethora of UNESCO World Heritage Sites.



CHARMING FRENCH CAFÉ



STRASBOURG'S ENCHANTING LA PETITE FRANCE

DAILY PROGRAMME FEATURES

DAY	DESTINATION	ACTIVITIES
1	Basel, Switzerland	⚓ EMBARKATION
2	Breisach, Germany	Riquewihr walking tour OR Freiburg excursion OR Breisach tour
3	Strasbourg, France	City tour OR Old Town bike tour
4	Ludwigshafen, Germany	Mannheim Baroque Palace OR Heidelberg excursion OR Schwetzingen Gardens
	Rüdesheim, Germany	Siegfried's Mechanical Music Museum OR Rüdesheimer coffee
5	Rüdesheim, Germany	Gondola and wine tasting OR Rheingau bike tour OR Ehrenfels Castle hike
	Rhine Gorge	Scenic cruising
6	Trier, Germany	City tour OR Secrets of the Porta Nigra OR Trier bike tour
	Moselle River	Scenic cruising
	Bernkastel, Germany	Wine tasting
7	Bernkastel	Walking tour OR Moselle bike tour OR Bernkastel hike
		Scenic cruising
8	Cochem, Germany	Reichsburg Castle and walking tour OR Cochem Mustard Mill OR Cochem bike tour
	Koblenz, Germany	Evening walking tour
9	Cologne, Germany	Walking tour and Cologne Cathedral OR Kölsch beer tasting OR Bike tour
10	Amsterdam, The Netherlands	Canal cruise and city tour OR Jewish heritage tour OR Jordaan District walking tour
11	Amsterdam	⚓ DISEMBARKATION

⚓ Embark 10-Night Cruise

⚓ Disembark 10-Night Cruise

Note: Bike tours and hikes subject to weather and seasonality.

For full itinerary details, visit www.amawaterways.co.uk

INCLUDED FEATURES

- » 10 nights deluxe cruise accommodation in riverview stateroom or suite – most staterooms and suites offer twin balconies
- » Entertainment-On-Demand in all staterooms featuring free high-speed internet access, movies, a music library and English language TV stations
- » Fine dining, including unlimited complimentary hand-selected wines, beer and soft drinks with lunch and dinner on board
- » Multiple dining venues, including The Chef's Table specialty restaurant featuring our unique tasting menu
- » **NEW FOR 2018 – Sip & Sail daily cocktail hour with complimentary wine, beer, spirits and soft drinks**
- » Welcome Cocktail, Welcome Dinner, La Chaîne des Rôtisseurs Dinner, Captain's Cocktail and Gala Dinner
- » Complimentary Wi-Fi access on board
- » Guided shore excursions in every port, including Special Interest Tours, hiking and biking tours
- » Onboard live entertainment, theme dinners, cooking demonstration and more
- » Complimentary bicycles, helmets and Nordic walking sticks
- » Services of a professionally trained Cruise Manager throughout your cruise and land stay
- » Transfers between hotel and ship are included with the purchase of cruise and land package

YOUR ITINERARY

Day 1, EMBARKATION – BASEL, SWITZERLAND. Arrive in Basel and board your luxurious river cruise ship. Meet your fellow travellers tonight at the Welcome Dinner. (D)

Day 2, BREISACH. Step back in time with a visit to the enchanting Alsatian town of Riquewihr, which looks almost the same as it did in the 16th century. On your walking tour, admire historic architecture as well as famous sights, such as the Dolder Gate. Alternatively, you may wish to go to Freiburg, founded in 1120 and home to the Freiburg's Münster, a Gothic cathedral said to have "the most beautiful spire on earth." Those wishing a more active excursion can cycle through the scenic countryside. (B,L,D)

Day 3, STRASBOURG. Strasbourg, the capital city of Alsace, offers flavours of both France and Germany because of its borderline location. Enjoy a panoramic tour past the stunning Parc de l'Orangerie, the European Parliament and the Place de la République. Then walk through its iconic "La Petite France" district, which appears to have been lifted straight from the pages of a fairytale. Wander through these charming streets and past the Cathédrale de Notre Dame with its famous

astronomical clock. Alternatively, the active adventurer can take a guided bike ride through this captivating city and Parc de l'Orangerie. (B,L,D)

Day 4, LUDWIGSHAFEN – RÜDESHEIM. You have several choices of morning excursions. Explore the glorious Mannheim Baroque Palace, one of Europe's largest. Prefer to visit the town Mark Twain wrote about in "A Tramp Abroad," then join a tour to perfectly preserved Heidelberg. Alternatively, visit Schwetzingen Palace Gardens, a cultural heritage site of European significance. Wander through the gardens with more than 100 sculptures and admire an assortment of whimsical buildings. Later in the day, sail to Rüdesheim where you can visit Siegfried's Mechanical Music Museum; or taste one of the town's special delights, Rudesheimer Coffee, ceremoniously made with brandy. (B,L,D)

Day 5, RÜDESHEIM – RHINE GORGE. Your exploration of Rüdesheim continues with your choice of three excursions. Take a gondola ride to the Niederwalddenkmal Statue, where you can enjoy panoramic views of the river. Afterwards, indulge your taste buds with a sampling of Riesling wines in the vineyards. Alternatively, you can



BURG PFALZGRAFENSTEIN RHINE RIVER

RHINE & MOSELLE DELIGHTS

join a guided bike ride through the town and along the Rhine River; or hike to Ehrenfels Castle, idyllically situated in the midst of the vineyards. During the afternoon, set sail along the scenic Rhine River Gorge with its fabled legends and many castles. (B,L,D)

Day 6, TRIER – BERNKASTEL. In Trier, Germany's oldest city, discover such sights as the old Roman amphitheatre, Roman Baths and Basilica of Constantine on a city tour. Alternatively, go in search of the secrets of the Porta Nigra Gate on a tour that takes you back to a time when Rome ruled the world from the Emperor's seat in Trier. You also have the choice of a bike tour through the historic city centre and along the Moselle River. Later in the day, set sail along the scenic Moselle en route to Bernkastel, where you'll visit a local winery for a special tasting. (B,L,D)

Day 7, BERNKASTEL. Located in the middle of the Moselle Valley's wine-producing region, an area that's been cultivating wine for over 500 years, Bernkastel will enchant you. Walk through its colourful Old Town centre and past many medieval and Renaissance buildings on a guided tour. Cycling enthusiasts can choose to join a bike tour along the shores of the Moselle River; and hikers can opt to trek up to the ruins of Landshut Castle, which dates all the way back to the 9th century. During the afternoon, enjoy scenic sailing along the Moselle. (B,L,D)

Day 8, COCHEM – KOBLENZ Visit the Reichsburg Castle, an integral part of the town's history followed by a walking tour along Cochem's narrow cobblestone streets lined with medieval houses. For a more active excursion, go on a biking tour along the Moselle River. As an alternative excursion, you can visit one of Europe's oldest working mustard mills where you will sample Cochem's famous mustard. Later in the day, sail to Koblenz, and join a walking tour through the picturesque Old Town. (B,L,D)

Day 9, COLOGNE. Join a guided tour through the Old Town and explore the UNESCO-designated cathedral. Continue on to the Cologne Rathaus, Germany's oldest town hall, the Overstolzenhaus and the Festival Hall. For a different view of the city, visit a local tavern to taste its famous Kölsch beer, only made in Cologne, and Reibekuchen, potato pancakes typically served with apple sauce. Active adventurers will want to join a guided bike ride along the Rhine and through the historic Stadtgarten. (B,L,D)

Day 10, AMSTERDAM. View Amsterdam on a scenic canal cruise followed by a walk to Begijnhof, known for its Middle Age buildings. For a different view of the city, join the Jordaan District tour or the Jewish Heritage tour. The Jordaan District tour begins at the Westerchurch and takes you past the Noordermarkt, the Karthuizerhof and the "9 streets"; afterwards, you'll stop in a local café for a hot beverage and Dutch apple pie. The Jewish Heritage tour begins with a visit to the 17th-century Portuguese Synagogue and the Jewish Historical Museum chronicling the history of the Jewish community in Amsterdam. (B,L,D)

Day 11, DISEMBARKATION – AMSTERDAM. Bid Farewell to Amsterdam and prepare for your flight home. (B)

LAND PROGRAMME OPTIONS – PRE-CRUISE

SWITZERLAND – 3 NIGHTS

Switzerland's largest city, Zurich, seamlessly blends its historic past with its progressive future, which comes to life on your city tour. See Grossmünster Abbey; St. Peter, which boasts the world's largest church clock face; Old Town and Town Hall. Depart Zurich for a scenic drive to Vitznau on Lake Lucerne. Admire the spectacular scenery during a lake cruise that takes you to Lucerne. Explore the city's well-preserved Old Town with its candy-coloured houses, architectural treasures and ancient covered wooden bridge and discover the iconic Lion Monument before transferring to Basel where you will embark your ship.



SOARING OVER RÜDESHEIM

DATES AND FARES (£)

EMBARK DATE	START CITY	SHIP NAME	10-NIGHT CRUISE
May 30	Basel	AmaPrima	£3,359
Jul 18	Basel	AmaPrima	£3,293
Sep 05	Basel	AmaPrima	£3,559
Oct 24	Basel	AmaPrima	£3,159
Dec 22	Basel	AmaPrima	£2,826

■ Christmas Cruise; visit www.amawaterways.co.uk for detailed itinerary.

Flights: Please call for fares and availability.

Transfers: Basel Airport to Ship: from £40 per person.
Ship to Amsterdam Airport: from £20 per person.

Cruise fares are per person based on double occupancy in a Cat. E, deluxe outside stateroom with window. To upgrade to a higher category, add per person:

CAT.	DECK	STATEROOM	ADD'L
D	Piano	Window	£286
C	Violin & Cello	French Balcony	£866
BB	Cello	French/Outside Balcony	£1,333
BA	Violin	French/Outside Balcony	£1,533
AB	Cello	French/Outside Balcony	£1,733
AA	Violin	French/Outside Balcony	£1,933
AA+	Violin	French/Outside Balcony	£2,466
Suite	Violin	French/Outside Balcony	£3,133

Port Charges: Fares include port charges of £160 per person

Single Supplement: Categories E – AA: add 50% per person; Categories AA+ and Suite: add 100% per person. Single supplement may be waived on D and E categories subject to availability. Please check at time of booking.

Bedding: Please select bedding configuration at the time of booking.

Option A: Two twin beds

Option B: One large bed (larger than queen size)

Deck Plans: AMAPRIMA – See page 166

LAND PROGRAMMES

PRE-CRUISE – 3 NIGHTS SWITZERLAND from £840 per person

Additional Hotel Nights (prices subject to change due to seasonality):

Prices are per person

Basel: Double occupancy – £234, Single occupancy – £467

Zurich: Double occupancy – £154, Single occupancy – £307

Amsterdam: Double occupancy – £180, Single occupancy – £360

Additional hotel nights include portage, breakfast, as well as transfers to/from the ship only in cities where the ship is embarking or disembarking.

Single Supplement: 3 Nights Switzerland £320 per person

For more information on hotels, please see page 42.

THE RHINE & MOSELLE RIVERS



BURG LANDSHUT CASTLE, MOSELLE RIVER

RHINE & MOSELLE FAIRYTALES

11 NIGHTS • AMSTERDAM TO BASEL

DRAMATIC RIVERS YIELD TO FAIRYTALE TOWNS AND ICONIC CITIES ALL COME ALIVE AS YOU DISCOVER THE STORIED RHINE AND MOSELLE



Pages from fairytales come to life as you find inspiration along the fabled castle-laden Rhine and its breathtaking tributary, the Moselle. Encounter some of the prettiest towns along the way: Strasbourg, Riquewihr, Cochem and Bernkastel. Colourful canals and glistening lakes, hilltop towns and the majestic Alps, mighty fortresses and storied castles, and hearty beer and delicate wines—can all be experienced on this fairytale journey through time.



WINE TASTING ALONG THE RHINE



SCHWETZINGEN GARDENS, GERMANY

DAILY PROGRAMME FEATURES

DAY	DESTINATION	ACTIVITIES
1	Amsterdam, The Netherlands	EMBARKATION
2	Amsterdam	Canal cruise and city tour Scenic cruising
3	Cologne, Germany	Walking tour and Cologne Cathedral OR Kölsch beer tasting OR Cologne bike tour
4	Koblenz, Germany	Walking tour OR Cable car and Ehrenbreitstein Fortress OR Two rivers bike tour
	Moselle	Scenic cruising
5	Cochem, Germany	Reichsburg Castle and walking tour OR Bundesbank Bunker tour OR Cochem hike
6	Trier, Germany	Scenic cruising; City tour OR Secrets of the Porta Nigra OR Trier bike tour
7	Bernkastel, Germany	Walking tour and wine tasting OR Moselle bike tour OR Bernkastel hike
8	Rhine Gorge Rudesheim, Germany	Scenic cruising Gondola ride OR Wine tasting OR Rheingau bike tour Siegfried's Mechanical Music Museum OR Rudesheimer coffee
9	Ludwigshafen, Germany	Mannheim Baroque Palace OR Heidelberg OR Schwetzingen Gardens
10	Strasbourg, France	City tour OR Old Town bike tour
11	Breisach, Germany	Riquewihr walking tour OR Freiburg excursion OR Breisach bike tour
12	Basel, Switzerland	DISSEMBARKATION

⚓ Embark 11-Night Cruise

⚓ Disembark 11-Night Cruise

Note: Bike tours and hikes subject to weather and seasonality.

For full itinerary details, visit www.amawaterways.co.uk

INCLUDED FEATURES

- » 11 nights deluxe cruise accommodation in riverview stateroom or suite – most staterooms and suites offer twin balconies
- » Entertainment-On-Demand in all staterooms featuring free high-speed internet access, movies, a music library and English language TV stations
- » Fine dining, including unlimited complimentary hand-selected wines, beer and soft drinks with lunch and dinner on board
- » Multiple dining venues, including The Chef's Table specialty restaurant featuring our unique tasting menu
- » **NEW FOR 2018 – Sip & Sail daily cocktail hour with complimentary wine, beer, spirits and soft drinks**
- » Welcome Cocktail, Welcome Dinner, La Chaîne des Rôtisseurs Dinner, Captain's Cocktail and Gala Dinner
- » Complimentary Wi-Fi access on board
- » Guided shore excursions in every port, including Special Interest Tours, hiking and biking tours
- » Onboard live entertainment, theme dinners, cooking demonstration and more
- » Complimentary bicycles, helmets and Nordic walking sticks
- » Services of a professionally trained Cruise Manager throughout your cruise and land stay
- » Transfers between hotel and ship are included with the purchase of cruise and land package

YOUR ITINERARY

Day 1, EMBARKATION – AMSTERDAM, THE NETHERLANDS. Arrive in Amsterdam and board your luxurious river cruise ship. (D)

Day 2, AMSTERDAM. The famous canals of Amsterdam await discovery on your city tour beginning with a scenic canal cruise. Tall narrow homes along the water, the beautiful wooden Skinny Bridge and the Anne Frank House are a few of the highlights you will see. You'll then walk to Begijnhof, known for its Middle Age buildings and followed by panoramic city tour. Later in the day, set sail out of Amsterdam (B,L,D)

Day 3, COLOGNE. Enjoy cruising to Cologne, home to one of Germany's most revered Gothic masterpieces, the Cologne Cathedral. Join a guided tour through the Old Town and explore the UNESCO-designated cathedral. Continue on to the Cologne Rathaus, Germany's oldest town hall, the Overstolzenhaus and the Festival Hall. For a different view of the city, visit a local tavern to taste its famous Kölsch beer, only made in Cologne, and Reibekuchen, potato pancakes typically served with apple sauce. Active adventurers will want to join a guided bike ride along the Rhine and through the historic Stadtgarten. (B,L,D)

Day 4, KOBLENZ. Learn about Koblenz's history and strategic importance due to its location at the confluence of the Rhine and Moselle rivers on a guided tour taking you past cultural monuments and historic buildings, including the Monument of Emperor Wilhelm I and the Clock Tower, where you will see the Augenroller (eye roller). Or take a cable car across the Rhine where you can discover Ehrenbreitstein Fortress. And for a more active adventure, explore the town and surrounding area on the "Two rivers bike tour," which takes you along both the Rhine and Moselle rivers. (B,L,D)

Day 5, COCHEM. Spend the morning taking in the beauty of the Moselle on this scenic stretch of the river before reaching Cochem with its half-timbered houses and Reichsburg Castle. Join a guided tour through the castle, situated high above the town, and then walk through its Old Town. For those wishing to have a more active exploration of the area, you can go on a guided hike to the castle. Or for a different adventure, explore the Bundesbank Bunker to get a closer look at this mysterious Cold War era bank vault. (B,L,D)

Day 6, TRIER. In Trier, Germany's oldest city, you will discover such sights as the old Roman amphitheatre,



KOBLENZ, GERMANY

RHINE & MOSELLE FAIRYTALES

Roman Baths and Basilica of Constantine. Alternatively, go in search of the secrets of the Porta Nigra Gate on a tour that takes you back to a time when Rome ruled the world from the Emperor's seat in Trier. Hear the history, secrets and stories of the bishops and barbarians who have crossed through this famed gate that dates back to 180 A.D. You also have the choice to go on a bike tour through the historic city centre and along the Moselle River. (B,L,D)

Day 7, BERNKASTEL. Bernkastel, located in the middle of the Moselle Valley's wine-producing region, an area which has been cultivating wine for over 500 years, will enchant you. Walk through its colourful Old Town centre and past many medieval and Renaissance buildings on a guided tour that also includes a winery visit. Cycling enthusiasts can choose to join a bike tour along the shores of the Moselle River; and hikers can opt to trek up to the ruins of Landshut Castle, which dates all the way back to the 9th century. (B,L,D)

Day 8, RHINE GORGE – RÜDESHEIM. Cruise through the captivating UNESCO-designated Rhine Gorge, the most stunningly beautiful stretch of the river before reaching the winemaking town of Rüdesheim. Wine connoisseurs will want to go on a walking tour through the vineyards where you'll stop to sample wines at three different tasting stations. Or choose to drink up the stunning views by soaring high above the vineyards with a gondola ride to the Niederwalddenkmal Statue. For a more active adventure, join a guided bike tour along the scenic Rhine River. Later in the day, let Siegfried's Mechanical Music Museum charm you with its remarkable collection of self-playing musical instruments; or taste one of the town's special delights, Rüdesheimer Coffee, ceremoniously made with brandy, coffee and whipped cream. (B,L,D)

Day 9, LUDWIGSHAFEN. Discover a grand Baroque palace, one of Mark Twain's favourite European towns or one of the most whimsical gardens in the Europe on choice of excursions. Relieve a bygone era on an excursion to the Mannheim Baroque Palace, one of Europe's largest. Prefer to fall in love with one of Mark Twain's favourite towns, then join a tour to perfectly preserved Heidelberg. For those who love a bit of whimsy, visit Schwetzingen Palace Gardens, a cultural heritage site of European significance. (B,L,D)

Day 10, STRASBOURG. Strasbourg, the capital city of Alsace, enchants offering flavours of both France and

Germany because of its borderline location. Enjoy a panoramic tour past the stunning Parc de l'Orangerie, the European Parliament and the Place de la République before walking through its iconic "La Petite France" district, which appears to have been lifted straight from the pages of a fairytale. Wander through these charming streets and past the Cathédrale de Nôtre Dame with its famous astronomical clock. Alternatively, the active adventurer can take a guided bike ride through the city and Parc de l'Orangerie. (B,L,D)

Day 11, BREISACH. Step back in time with a visit to the enchanting Alsatian town of Riquewihir. Having survived WWII without being damaged, this charming medieval hamlet looks almost the same as it did in the 16th century. On your walking tour, admire historic architecture and surrounding vineyards as well as famous sights, such as the Dolder Gate. Alternatively, you may wish to go to Freiburg, founded in 1120 and home to the Freiburg's Münster, a Gothic cathedral said to have "the most beautiful spire on earth." Those wishing a more active excursion can cycle through the scenic countryside. (B,L,D)

Day 12, DISEMBARKATION – BASEL. Disembark after breakfast and prepare for your journey home. (B)

LAND PROGRAMME OPTIONS – POST-CRUISE

SWITZERLAND – 3 NIGHTS

Disembark the ship and depart for Zurich. En route, stop in Lucerne where you will visit the Lion Monument and take a walking tour before enjoying a leisurely cruise across the tranquil waters of Lake Lucerne to Vitznau. Here you will enjoy a scenic drive through the countryside, before arriving in Zurich. Set alongside a gleaming lake and framed by the Alps, Switzerland's largest city, Zurich, seamlessly blends its historic past with its progressive future—all of which will be on full display during your city tour. See Grossmünster Abbey; St. Peter, which boasts the world's largest church clock face; Old Town; Town Hall; and Fraumünster Abbey.

DATES AND FARES (£)

EMBARK DATE	START CITY	SHIP NAME	11-NIGHT CRUISE
May 19	Amsterdam	AmaPrima	£3,709
Jul 07	Amsterdam	AmaPrima	£3,509
Aug 25	Amsterdam	AmaPrima	£3,775
Oct 13	Amsterdam	AmaPrima	£3,709

Flights: Please call for fares and availability.

Transfers: Amsterdam Airport to Ship: from £20 per person. Ship to Basel Airport: from £40 per person.

Cruise fares are per person based on double occupancy in a Cat. E, deluxe outside stateroom with window. To upgrade to a higher category, add per person:

CAT.	DECK	STATEROOM	ADD'L
D	Piano	Window	£313
C	Violin & Cello	French Balcony	£933
BB	Cello	French/Outside Balcony	£1,466
BA	Violin	French/Outside Balcony	£1,666
AB	Cello	French/Outside Balcony	£1,866
AA	Violin	French/Outside Balcony	£2,133
AA+	Violin	French/Outside Balcony	£2,733
Suite	Violin	French/Outside Balcony	£3,466

Port Charges: Fares include port charges of £176 per person

Single Supplement: Categories E – AA: add 50% per person; Categories AA+ and Suite: add 100% per person. Single supplement may be waived on D and E categories subject to availability. Please check at time of booking.

Bedding: Please select bedding configuration at the time of booking. Option A: Two twin beds
Option B: One large bed (larger than queen size)

Deck Plans: AMAPRIMA – See page 166

LAND PROGRAMMES

POST-CRUISE – 3 NIGHTS SWITZERLAND from £840 per person

Additional Hotel Nights (prices subject to change due to seasonality):

Prices are per person

Amsterdam: Double occupancy – £180, Single occupancy – £360

Zurich: Double occupancy – £154, Single occupancy – £307

Basel: Double occupancy – £234, Single occupancy – £467

Extra hotel nights include portage, breakfast, as well as transfers to/from the ship only in cities where the ship is embarking or disembarking.

Single Supplement: 3 Nights Switzerland £320 per person

For more information on hotels, please see page 42.



THE RHINE & DANUBE RIVERS



MAGNIFICENT EUROPE

14 NIGHTS · AMSTERDAM TO BUDAPEST (OR REVERSE)

EXPERIENCE EUROPE'S LARGEST RIVERS AS YOU TRAVEL ACROSS THE RHINE, MAIN AND DANUBE



Delve into Europe's past and present along three rivers and through five countries. The Rhine, Main and Danube yield way to countless UNESCO World Heritage Sites from Cologne's cathedral to the Melk Abbey. Visit four capital cities—Amsterdam, Vienna, Bratislava and Budapest—along with towns seemingly lifted from the pages of fairytales such as Miltenberg, Bamberg, Nuremberg and Dürnstein. Discover the romance, intrigue, history and culture on this magnificent journey through time.



VIENNA, AUSTRIA



BAMBERG, GERMANY - A UNESCO WORLD HERITAGE SITE

DAILY PROGRAMME FEATURES

DAY	DESTINATION	ACTIVITIES
1	Amsterdam, The Netherlands	EMBARKATION
2	Amsterdam	Canal cruise and city tour
3	Cologne, Germany	Walking tour and cathedral visit OR Kölsch beer tasting OR Cologne bike tour
4	Rhine Gorge Rudesheim, Germany	Scenic cruising Siegfried's Mechanical Music Museum OR Gondola ride OR Rudesheimer Coffee
5	Miltenberg, Germany Wertheim, Germany	Walking tour OR Hike tour Walking tour OR Pretzel bakery visit and tasting OR Bike tour
6	Würzburg, Germany	Walking tour OR Residenz Palace tour OR Marienberg Fortress hike
7	Bamberg, Germany	Walking tour and smoked beer tasting OR Bamberg bike tour OR Bamberg specialties tasting
8	Nuremberg, Germany	WWII city tour OR Medieval city tour OR Franconian specialties tasting Cruise Main-Danube Canal
9	Regensburg, Germany	Walking tour OR Bavarian specialties tasting OR Walhalla bike tour
10	Passau, Germany	Walking tour OR Passau bike tour OR Passau Castle hike
11	Melk, Austria Wachau Valley	Benedictine Abbey tour OR Danube bike tour Scenic cruising OR Melk to Dürnstein bike tour
	Dürnstein, Austria	Walking tour and wine tasting OR Dürnstein Fortress hike OR Apricots and Sweets tasting
12	Vienna, Austria	City tour OR Alte Donau bike tour Free time OR Klosterneuburg bike tour
13	Bratislava, Slovakia	Walking tour OR Bratislava hike OR Slovakian specialties tasting
14	Budapest, Hungary	City tour OR Castle Hill hike Illuminations cruise
15	Budapest	DISEMBARKATION

⚓ Embark 14-Night Cruise

⚓ Disembark 14-Night Cruise

Note: Bike tours and hikes subject to weather and seasonality.

For full itinerary details, visit www.amawaterways.co.uk

INCLUDED FEATURES

- » 14 nights deluxe cruise accommodation in riverview stateroom or suite – most staterooms and suites offer twin balconies
- » Entertainment-On-Demand in all staterooms featuring free high-speed internet access, movies, a music library and English language TV stations
- » Fine dining, including unlimited complimentary hand-selected wines, beer and soft drinks with lunch and dinner on board
- » Multiple dining venues, including The Chef's Table specialty restaurant featuring our unique tasting menu
- » **NEW FOR 2018 – Sip & Sail daily cocktail hour with complimentary wine, beer, spirits and soft drinks**
- » Welcome Cocktail, Welcome Dinner, La Chaîne des Rôtisseurs Dinner, Captain's Cocktail and Gala Dinner
- » Complimentary Wi-Fi access on board
- » Guided shore excursions in every port, including Special Interest Tours, hiking and biking tours
- » Onboard live entertainment, theme dinners, cooking demonstration and more
- » Complimentary bicycles, helmets and Nordic walking sticks
- » Services of a professionally trained Cruise Manager throughout your cruise and land stay

YOUR ITINERARY

Day 1, EMBARKATION – AMSTERDAM, THE NETHERLANDS. Arrive in Amsterdam and board your luxurious river cruise ship. (D)

Day 2, AMSTERDAM. Discover Amsterdam's iconic canals and leaning houses with a scenic canal cruise. Continue with a walk to the Begijnhof and be charmed by its historic buildings dating back to the Middle Ages. Later in the day, set sail. (B,L,D)

Day 3, COLOGNE. Join a guided tour through the Old Town and explore the Gothic cathedral. For a different view of the city, visit a local tavern to taste its famous Kölsch beer and Reibekuchen, potato pancakes typically served with apple sauce. Active adventurers can join a guided bike ride along the Rhine and through the historic Stadtgarten. (B,L,D)

Day 4, RHINE GORGE – RÜDESHEIM. Cruise through the captivating UNESCO-designated Rhine Gorge, the most stunningly beautiful stretch of the river before reaching the winemaking town of Rüdesheim. Wine connoisseurs will want to go on a walking tour through the vineyards

where you'll stop to sample wines at three different tasting stations. Or choose to drink up the stunning views by soaring high above the vineyards with a gondola ride to the Niederwalddenkmal Statue. For a more active adventure, join a guided bike tour along the scenic Rhine River. Later in the day, let Siegfried's Mechanical Music Museum charm you with its remarkable collection of self-playing musical instruments; or taste one of the town's special delights, Rüdeshheimer Coffee. (B,L,D)

Day 5, MILTENBERG – WERTHEIM. While on your walking tour of Miltenberg, discover why this medieval town seems to leap from the pages of a fairytale. Prefer to explore Miltenberg more actively, go on a hike. Later in the day, enjoy a walking tour of Wertheim, which has one of the most beautiful city centres in Germany. Those wishing to learn more about the art of pretzel making can join a demonstration and tasting, and for the more actively inclined, go on a guided bike tour. (B,L,D)

Day 6, WÜRZBURG. Nestled along the "Romantic Road" lies Würzburg. Join a walking tour of this beautiful city,



MAGNIFICENT EUROPE

or visit its crown jewel, the Baroque Residenz, a UNESCO World Heritage Site. Get more active with a hike up to the Marienberg Fortress, the most prominent landmark on the left bank of the Main River in Würzburg. (B,L,D)

Day 7, BAMBERG. Explore enchanting Bamberg, a UNESCO World Heritage Site, in one of three ways. Join a guided walking tour of this medieval gem to see its cathedral, Old Town Hall and elegant old mansions. Or taste your way through the city with tastings of smoked beer, licorice root and Hornla, a pastry. And for a more active adventure, join a guided bike tour. (B,L,D)

Day 8, NUREMBERG. You have three choices of excursions while in Nuremberg. Enjoy a guided tour through this well-preserved medieval city, showcasing the Imperial Castle, famous town wall and the legendary fountain of the Market Square. Or turn back the pages of a darker history with a guided tour of the city's most important WWII sites, including the coliseum. You'll also visit the Nuremberg Trials Memorial and Courtroom 600, if the courtroom is not in session. Alternatively, partake in a traditional Franconian specialties tasting of famous Nuremberger Bratwurst, Rotbier (red beer) and Lebkuchen (gingerbread). Later in the day, cruise through the man-made marvel, the Main-Danube Canal, en route to Regensburg. (B,L,D)

Day 9, REGENSBURG. Explore one of Germany's best preserved medieval cities, Regensburg on a guided walking tour showcasing the city's architectural highlights, including the Old Town Hall and the Porta Praetoria. As an alternative sample some of Bavaria's specialties—beer, sausage and pretzels. And for a more active adventure, bike to Walhalla where you will see the neo-Classical white marble temple. (B,L,D)

Day 10, PASSAU. Discover Passau in one of three ways. Enjoy a walking tour and marvel at Gothic and Italian Baroque architecture and St. Stephen's Cathedral. Guests looking for a more active morning can choose between a guided bike tour along the Danube, or a guided hike up to the Veste Oberhaus Fortress. (B,L,D)

Day 11, MELK - DÜRNSTEIN. Cruise to Melk, known for its magnificent Benedictine Abbey, a UNESCO World Heritage Site. You can also join a guided bike tour along the Danube, and if you would like, you can bike later in the day further along the Danube through the UNESCO-designated Wachau Valley that will take you to Dürnstein. For those not biking, you'll cruise through the Wachau

Valley to Dürnstein. Once here, you have a choice of excursions. Partake in a walking tour along cobblestone streets to the Baroque Stiftskirche, before enjoying a local wine tasting. For a more active adventure, hike up to the fortress where Richard the Lionheart was once held. You may also choose to visit a local apricot grower, where you'll be treated to the finest apricot products in the region. (B,L,D)

Day 12, VIENNA. Discover the "City of Waltzes" on a city tour showcasing its many regal splendours, such as the majestic Opera House and St. Stephen's Cathedral before concluding in Vienna's historic city centre, a UNESCO World Heritage Site. Prefer a more active adventure, then join a guided bike ride along the Danube. Later in the day, enjoy leisure time in Vienna or cycle to Klosterneuburg Monastery on a bike tour (B,L,D)

Day 13, VIENNA - BRATISLAVA. Sail to the "Coronation City of Kings," where you can join a walking tour or choose instead to taste local Slovakian specialties and learn how to prepare stuffed potato ravioli. For those who wish a more active exploration, hike up to Bratislava Castle for magnificent views of the city. (B,L,D)

Day 14, BUDAPEST. Discover the "Queen of the Danube" on your city tour beginning with a visit to the Great Market Hall followed by a panoramic tour of both the Buda and the Pest sides of the river. As an alternative choice, hike up to Castle Hill. Spend your last evening on board cruising around the famed Parliament Building as the city turns on all her dazzling lights. (B,L,D)

Day 15, DISEMBARKATION - BUDAPEST. Bid adieu to Budapest and prepare for your flight home. (B)

Note: Budapest's Great Market Hall is closed on Sundays.



DATES AND FARES (£)

EMBARK DATE	START CITY	SHIP NAME	14-NIGHT CRUISE
May 06	Amsterdam	AmaLea	£4,357
May 27	Amsterdam	AmaSonata	£4,490
Jun 09	Amsterdam	AmaPrima	£4,490
Jun 23	Budapest	AmaPrima	£4,490
Jul 28	Amsterdam	AmaPrima	£4,357
Aug 11	Budapest	AmaPrima	£4,357
Dec 21	Budapest	AmaSerena	£3,823

■ Christmas & New Year's Cruise
Visit www.amawaterways.co.uk for detailed itinerary.

Flights: Please call for fares and availability.
Transfers: Amsterdam Airport to Ship (or reverse): from £20 per person.
Ship to Budapest Airport (or reverse): from £20 per person.

Cruise fares are per person based on double occupancy in a Cat. E, deluxe outside stateroom with window. To upgrade to a higher category, add per person:

CAT.	DECK	STATEROOM	ADD'L
D	Piano	Window	£399
CB	Violin	French Balcony	£799
CA/C	Violin & Cello	French Balcony	£1,199
BB	Cello	French/Outside Balcony	£1,865
BA	Violin	French/Outside Balcony	£2,132
AB	Cello	French/Outside Balcony	£2,399
AA	Violin	French/Outside Balcony	£2,665
AA+	Violin	French/Outside Balcony	£3,465
Suite	Violin	French/Outside Balcony	£4,399

Single Supplement: Categories E - AA: add 50% per person; Categories AA+ and Suite: add 100% per person. Single supplement may be waived on D and E categories subject to availability. Please check at time of booking.

Port Charges: Fares include port charges of £224 per person

Bedding: Please select bedding configuration at the time of booking.
Option A: Two twin beds
Option B: One large bed (larger than queen size)

Deck Plans: AMALEA - See page 164

AMAPRIMA, AMASERENA & AMASONATA - See page 166

Hotel Nights (prices subject to change due to seasonality):

Prices are per person
Amsterdam: Double occupancy - £180, Single occupancy - £360
Budapest: Double occupancy - £100, Single occupancy - £200

Additional hotel nights include portorage, breakfast, as well as transfers to/from the ship only in cities where the ship is embarking or disembarking. For more information on hotels, please see page 42.

THE DANUBE RIVER

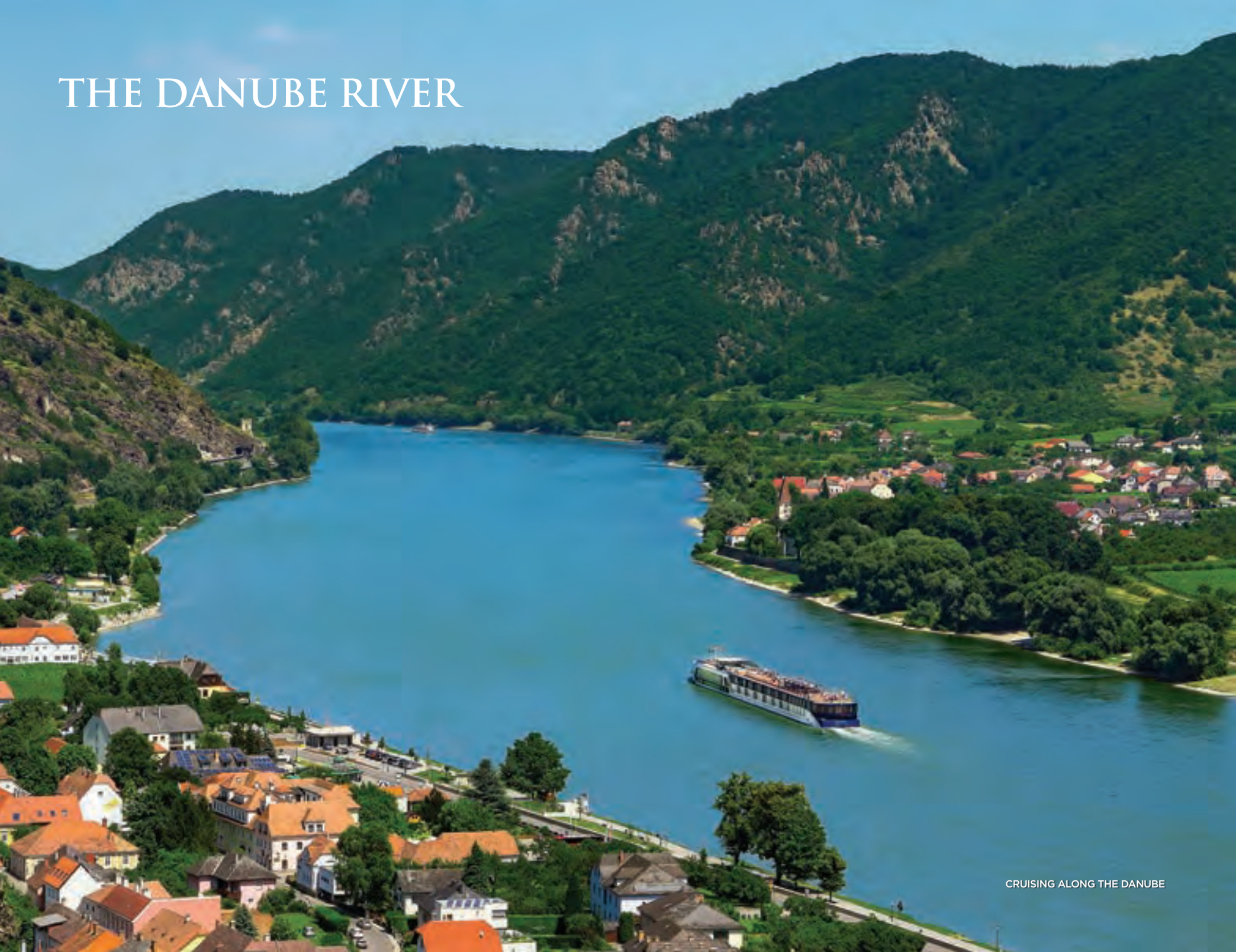

GRAND DANUBE CRUISE

14 NIGHTS · NUREMBERG TO GIURGIU (OR REVERSE)

ENJOY THE FULL MAGNIFICENCE OF THE DANUBE TRAVELLING THROUGH 7 COUNTRIES TOWARDS THE BLACK SEA



Journey along paths forged by conquerors, crusaders and kings through Germany, Austria, Slovakia, Hungary, Croatia, Serbia, Bulgaria and Romania. Step back in time to explore the history and mystery living in the hillsides while cruising the Danube and through the Iron Gates. Legends of all kinds are waiting to be uncovered from the Great Hungarian Plain to Bulgaria's Belogradchik on an extraordinary voyage through the ages.



CRUISE THROUGH THE IRON GATES



GREAT MARKET HALL, BUDAPEST, HUNGARY

DAILY PROGRAMME FEATURES

DAY	DESTINATION	ACTIVITIES
1	Nuremberg, Germany	⚓ EMBARKATION
2	Nuremberg	Medieval city tour OR WWII city tour Cruise Main-Danube Canal
3	Regensburg, Germany	Walking tour OR Walhalla bike tour OR Bavarian specialties tasting
4	Passau, Germany Linz, Austria	Walking tour OR Passau bike tour OR Passau Castle hike Scenic cruising
5	Melk, Austria	Benedictine Abbey tour OR Danube bike tour
	Wachau Valley Vienna, Austria	Scenic cruising Free time
6	Vienna	City tour OR Alte Donau bike tour Klosterneuburg bike tour
7	Budapest, Hungary	City tour OR Castle Hill hike Free time; Illuminations cruise
8	Budapest	Puszta excursion
9	Mohács, Hungary	Scenic cruising; Pécs excursion
10	Vukovar, Croatia Ilok, Croatia Novi Sad, Serbia	City tour OR Croatian wine tasting Walking tour OR Bike tour OR Hike tour Evening Petrovaradin Fortress visit
11	Belgrade, Serbia	City tour, Royal Palace and Tito's Memorial tour OR Quburich Brandy tasting OR Belgrade bike tour
12	Iron Gates, Serbia	Full-day scenic cruising
13	Vidin, Bulgaria	Baba Vida Fortress and Belogradchik hike OR Banitsa pastry and yoghurt tasting OR Vidin bike tour
14	Rousse, Bulgaria	Veliko Tarnovo excursion OR Rousse walking tour and Rock-hewn Churches
	Giurgiu, Romania	Free evening
15	Giurgiu	⚓ DISEMBARKATION

⚓ Embark 14-Night Cruise

⚓ Disembark 14-Night Cruise

Note: Bike tours and hikes subject to weather and seasonality.

For full itinerary details, visit www.amawaterways.co.uk

INCLUDED FEATURES

- » 14 nights deluxe cruise accommodation in riverview stateroom or suite – most staterooms and suites offer twin balconies
- » Entertainment-On-Demand in all staterooms featuring free high-speed internet access, movies, a music library and English language TV stations
- » Fine dining, including unlimited complimentary hand-selected wines, beer and soft drinks with lunch and dinner on board
- » Multiple dining venues, including The Chef's Table specialty restaurant featuring our unique tasting menu
- » **NEW FOR 2018 – Sip & Sail daily cocktail hour with complimentary wine, beer, spirits and soft drinks**
- » Welcome Cocktail, Welcome Dinner, La Chaîne des Rôtisseurs Dinner, Captain's Cocktail and Gala Dinner
- » Complimentary Wi-Fi access on board
- » Guided shore excursions in every port, including Special Interest Tours, hiking and biking tours
- » Onboard live entertainment, theme dinners, cooking demonstration and more
- » Complimentary bicycles, helmets and Nordic walking sticks
- » Services of a professionally trained Cruise Manager throughout your cruise and land stay
- » Transfers between hotel and ship are included with the purchase of cruise and land package

YOUR ITINERARY

Day 1, EMBARKATION – NUREMBERG, GERMANY. Meet your fellow travellers at a Welcome Dinner. The ship will moor overnight in Nuremberg. (D).

Day 2, NUREMBERG. You have two choices of excursions while in Nuremberg: one focusing on the medieval highlights and another focusing on WWII. Enjoy a guided tour through this medieval city, showcasing the Imperial Castle, famous town wall and Market Square's legendary fountain. Or turn back the pages of a darker history with a guided tour of the city's most important WWII sites, including the enormous Documentation Centre. You'll also visit the Nuremberg Trials Memorial and Courtroom 600, if it's not in session. En route to Regensburg, cruise through the man-made marvel, the Main-Danube Canal. (B,L,D)

Day 3, REGENSBURG. Explore one of Germany's best preserved medieval cities, Regensburg, on a guided walking tour showcasing the city's architectural highlights, including the Old Town Hall and the Porta Praetoria. Alternatively, sample some Bavarian specialties—beer, sausage and pretzels; and for those who wish to be more active, join a bike tour to Walhalla. (B,L,D)

Day 4, PASSAU – LINZ. Discover Passau in one of three ways. Enjoy a walking tour admiring the Gothic and Italian Baroque architecture and St. Stephen's Cathedral. Guests looking for a more active morning can choose between a guided bike tour or a hike up to the Veste Oberhaus Fortress for panoramic views of the city. Later in the day, enjoy a scenic cruise to Linz. (B,L,D)

Day 5, MELK – VIENNA. Cruise to Melk, known for its magnificent Benedictine Abbey, a UNESCO World Heritage Site and one of Europe's largest and most

revered monasteries. Alternatively, you can join a guided bike tour that takes you through the UNESCO designated Wachau Valley; or go on a walking tour along Dürnstein's cobblestone streets to the Baroque Stiftskirche, one of the finest Baroque towers in Austria. Later in the day, set sail through the vineyard-rich Wachau Valley (B,L,D)

Day 6, VIENNA. The “City of Waltzes” offers a treasure trove of gems, and you'll discover them on a city tour showcasing its many regal splendours, such as the majestic Opera House and the former Imperial Palace of the Habsburgs before concluding in Vienna's historic city centre, a UNESCO World Heritage Site. Prefer a more active adventure? Join a guided bike ride along the Danube. Later in the day, enjoy leisure time in Vienna or cycle to Klosterneuburg Monastery on a bike tour. (B,L,D)

Day 7, BUDAPEST. Get to know Budapest on a city tour that begins at the vibrant Great Market Hall and takes you to such places as the UNESCO-listed Castle Hill district, Fisherman's Bastion and St. Stephen's. Prefer a more active exploration, hike to Castle Hill. During the evening, be treated to a special Illuminations cruise past the capital's glittering river front. (B,L,D)

Day 8, BUDAPEST. Tradition will be on full display in Pusztá, the Great Hungarian Plain. Tour a genuine Hungarian csárda (farm) run by the world champion carriage-drivers, the Lazar brothers. Afterwards, be treated to an unforgettable performance of Hungarian horsemanship and then experience the Hungarians' warm hospitality, along with a traditional lunch complete with typical Goulash. (B,L,D)

Day 9, MOHÁCS. Enjoy a scenic morning cruise to Pécs, founded more than 2,000 years ago by the Romans. Visit the UNESCO-designated Christian Necropolis; St. Peter's



PUSZTA HORSES, BUDAPEST



PELEŞ CASTLE, ROMANIA

GRAND DANUBE CRUISE

Basilica, the city's main Catholic cathedral along with its catacombs; and Széchenyi Square, the heart of Old Town Pécs. You will also see the Mosque of Pasha Qasim the Victorious, one of the symbols of the city. (B,L,D)

Day 10, VUKOVAR – NOVI SAD, SERBIA. Vukovar is a Croatian symbol of resistance, which you'll better understand on your city tour showcasing the Ovčara Memorial and the Baroque Eltz Palace. Alternatively, choose a wine tasting in Ilok, a centre of wine production since Roman times, where you'll sample its famous Grasevina, Traminac and Frankovka wines. Back on board, cruise to Novi Sad, sometimes called the "Serbian Athens." Discover Novi Sad on a walking tour to Dunavski Park and through Stari Grad, the old town centre. If you prefer a more active exploration, join a guided biking or hiking tour. During the evening, visit Petrovaradin Fortress, a mighty stronghold no enemy has ever breached. (B,L,D)

Day 11, BELGRADE. Explore Serbia's capital, Belgrade, on a city tour, which includes the Kalemegdan Fortress and the Serbian Orthodox Temple of St. Sava. Later, choose from three intriguing excursions. Visit the Royal Palace, the official residence of the Serbian Royal Family; and then tour the House of Flowers, the mausoleum of Marshal Tito, who became the first President of Yugoslavia. Or enjoy a taste of the region by sampling Serbian plum brandy, Šljivovitz, and delicious local delights at the Quburich Distillery. For those wishing a more active adventure, join a guided bike tour. (B,L,D)

Day 12, SCENIC CRUISING THROUGH THE IRON GATES. The Iron Gates is one of Europe's most awe-inspiring natural wonders. The banks of the river dazzle with sheer-faced rocks stretching high overhead along this natural border between Serbia and Romania. (B,L,D)

Day 13, VIDIN. Explore Vidin, one of Bulgaria's oldest cities, and surrounding areas with choice of excursions. Discover Baba Vida Castle, the largest preserved medieval castle in Bulgaria overlooking the Danube. Continue on to Belogradchik, one of Bulgaria's natural wonders, where you can hike around its most spectacular rock formations. Alternatively, visit a local home for a demonstration of traditional Bulgarian yoghurt and Banitsa, a pastry you will also get to make. You also have the choice to bike through Vidin and to the castle. (B,L,D)

Day 14, ROUSSE – GIURGIU. Visit Bulgaria's ancient capital, Veliko Tarnovo, with its medieval fortress and multiple orthodox temples. You can opt instead to

go to Rousse, known for its 19th- and 20th-century Neo-Baroque and Neo-Rococo architecture, and then afterwards visit the UNESCO-designated Rock-hewn Churches of Ivanovo with frescoes revealing exceptional artistry of 14th-century paintings and Bulgarian medieval art. (B,L,D)

Day 15, DISEMBARKATION – GIURGIU. Disembark the ship in Giurgiu and prepare for your onward journey. (B)

LAND PROGRAMME OPTIONS – PRE-CRUISE

PRAGUE – 3 NIGHTS

Experience the wonders of Prague, considered one of Europe's most attractive cities, on a city tour. Visit the UNESCO-designated historic city centre with its many gems, including the Old Town Square, Astronomical Clock, Charles Bridge, Wenceslas Square and the 1,000 year-old Prague Castle. Prefer a more active tour? Hike to the castle. Depart from Prague and enjoy a stop in Pilsen, renowned for Pilsner beer. After a highlights tour, drive to Nuremberg where you will board your ship.

LAND PROGRAMME OPTIONS – POST-CRUISE

BRASOV & BUCHAREST – 3 NIGHTS

Journey through the Romanian countryside to Bran, where you'll visit Transylvania's legendary Bran Castle, which is forever linked with the legend of Dracula. Afterwards, travel to the lovely village of Braşov and enjoy a tour of the town, before staying overnight. En route to Bucharest, stop in Sinaia to visit Peleş Castle, Transylvania's other enchanting castle, considered by many to be one of the most stunning in Europe. Tour the castle, which was once the residence of the royal family. In Bucharest, Romania's capital, explore the "Little Paris of the East," with its wide boulevards and Arc de Triomphe. Enjoy a visit to the city's most impressive sites—including the historic city centre and the Palace of the Parliament, second only to the Pentagon as the largest administrative building in the world.

DATES AND FARES (£)

EMBARK DATE	START CITY	SHIP NAME	14-NIGHT CRUISE
Apr 07	Nuremberg	AmaCerto	£3,956
Apr 21	Giurgiu	AmaCerto	£4,356
May 05	Nuremberg	AmaCerto	£4,623
May 19	Giurgiu	AmaCerto	£4,689
Jun 02	Nuremberg	AmaCerto	£4,689
Jun 16	Giurgiu	AmaCerto	£4,689
Jul 14	Nuremberg	AmaCerto	£4,556
Jul 28	Giurgiu	AmaCerto	£4,556
Sep 08	Nuremberg	AmaCerto	£4,956
Sep 22	Giurgiu	AmaCerto	£4,956
Oct 06	Nuremberg	AmaCerto	£4,756
Oct 20	Giurgiu	AmaCerto	£4,356

Flights: Please call for fares and availability.

Transfers: Nuremberg Airport to Ship (or reverse): from £24 per person. Ship to Bucharest Airport (or reverse): from £66 per person.

Cruise fares are per person based on double occupancy in a Cat. E, deluxe outside stateroom with window. To upgrade to a higher category, add per person:

CAT.	DECK	STATEROOM	ADD'L
D	Piano	Window	£399
C	Violin & Cello	French Balcony	£1,199
BB	Cello	French/Outside Balcony	£1,865
BA	Violin	French/Outside Balcony	£2,132
AB	Cello	French/Outside Balcony	£2,399
AA	Violin	French/Outside Balcony	£2,665
AA+	Violin	French/Outside Balcony	£3,465
Suite	Violin	French/Outside Balcony	£4,399

Port Charges: Fares include port charges of £224 per person

Single Supplement: Categories E – AA: add 50% per person; Categories AA+ and Suite: add 100% per person. Single supplement may be waived on D and E categories subject to availability. Please check at time of booking.

Bedding: Please select bedding configuration at the time of booking.

Option A: Two twin beds

Option B: One large bed (larger than queen size)

Deck Plans: AMACERTO – See page 166

LAND PROGRAMMES

PRE-CRUISE – 3 NIGHTS PRAGUE from £520 per person

POST-CRUISE – 3 NIGHTS ROMANIA (1 NIGHT BRASLOV & 2 NIGHTS BUCHAREST) from £640 per person

Additional Hotel Nights (prices subject to change due to seasonality):

Prices are per person

Prague: Double occupancy – £94, Single occupancy – £187

Nuremberg: Double occupancy – £124, Single occupancy – £247

Bucharest: Double occupancy – £67, Single occupancy – £134

Upgrade to the Four Seasons in Prague is available; ask for details.

Additional hotel nights include portage, breakfast, as well as transfers to/from the ship only in cities where the ship is embarking or disembarking.

Single Supplement: 3 Nights Prague £320 per person

3 Nights Romania (1 Night Braslov & 2 Nights Bucharest £320 per person

For more information on hotels, please see page 42.

THE DANUBE RIVER



CHRISTMAS TREE, BUDAPEST, HUNGARY

ICONIC CHRISTMAS MARKETS

7 NIGHTS • BUDAPEST TO NUREMBERG (OR REVERSE)

CELEBRATE CHRISTMAS ON THE STUNNING DANUBE WITH THIS FESTIVE VOYAGE



Three countries—Hungary, Austria and Germany—await your arrival for a festive celebration. Ageless traditions and elegant pageantry come alive from the grandest Christmas Markets of Budapest, Vienna and Nuremberg to the more intimate markets of Passau and Regensburg. Walk through the shadows of magnificent cathedrals and historic town squares, and as you do, warm your hands and your spirit with a mug of glühwein, and embrace the magic.



GERMANY'S FAMOUS NUTCRACKER



REGENSBURG, GERMANY

DAILY PROGRAMME FEATURES

DAY	DESTINATION	ACTIVITIES
1	Budapest, Hungary	✳️ EMBARKATION Illuminations cruise
2	Budapest	City tour and Vörösmarty Square Christmas Market
3	Vienna, Austria	Morning city tour with Town Hall Christmas Market OR Alte Donau bike ride Artisan and Schönbrunn Palace Christmas Markets Vienna by Night Christmas Markets
4	Melk, Austria Strudengau Valley	Benedictine Abbey visit OR Melk bike tour Scenic cruising
5	Passau, Germany	Walking tour and Christmas Market OR Passau bike tour OR Salzburg excursion and Christmas Market
6	Regensburg, Germany	Walking tour and Thurn & Taxis Royal Christmas Market OR Bavarian specialties tasting OR Walhalla bike tour
7	Nuremberg, Germany	Cruise Main-Danube Canal City tour OR Franconian specialties tasting Nuremberg Christmas Market
8	Nuremberg, Germany	⚓ DISEMBARKATION

✳️ Embark 7-Night Cruise

⚓ Disembark 7-Night Cruise

Note: Bike tours and hikes subject to weather and seasonality.

For full itinerary details, visit www.amawaterways.co.uk

INCLUDED FEATURES

- » 7 nights deluxe cruise accommodation in riverview stateroom or suite – most staterooms and suites offer twin balconies
- » Entertainment-On-Demand in all staterooms featuring free high-speed internet access, movies, a music library and English language TV stations
- » Fine dining, including unlimited complimentary hand-selected wines, beer and soft drinks with lunch and dinner on board
- » Multiple dining venues, including The Chef's Table specialty restaurant featuring our unique tasting menu
- » **NEW FOR 2018 – Sip & Sail daily cocktail hour with complimentary wine, beer, spirits and soft drinks**
- » Welcome Cocktail, Welcome Dinner, La Chaîne des Rôtisseurs Dinner, Captain's Cocktail and Gala Dinner
- » Complimentary Wi-Fi access on board
- » Guided shore excursions in every port, including Special Interest Tours, hiking and biking tours
- » Onboard live entertainment, theme dinners, cooking demonstration and more
- » Complimentary bicycles, helmets and Nordic walking sticks
- » Services of a professionally trained Cruise Manager throughout your cruise and land stay
- » Transfers between hotel and ship are included with the purchase of cruise and land package

YOUR ITINERARY

Day 1, EMBARKATION – BUDAPEST, HUNGARY. Arrive in Budapest and embark on your luxurious river cruise ship. During the evening, cruise along Budapest's famed illuminated riverfront. (D).

Day 2, BUDAPEST. Savour the beauty of Buda and Pest on opposite sides of the Danube with a city tour that showcases many highlights, including Heroes' Square and Castle Hill, home to Fisherman's Bastion and Matthias Church. In the centre of it all is the Christmas Market, where you can shop for traditional Hungarian wares and delightful holiday treats. (B,L,D)

Day 3, VIENNA. The "City of Waltzes" offers a treasure trove of gems just waiting to be discovered. Join a tour showcasing its regal splendours, such as the majestic Opera House and the former Imperial Palace of the Habsburgs before concluding in Vienna's historic city centre. Afterwards, you'll visit the Rathaus (Town Hall)

Christmas Market. If you prefer a more active adventure, then join a guided bike ride along the Danube. During the afternoon, visit the Karlsplatz (Artisans) Christmas Market, a local favourite, and the market at Schönbrunn Palace with a giant sparkling Christmas tree. Cap the day off with "Vienna by Night" Christmas Markets at the beautifully decorated Maria Theresaplatz Christmas Market, set amongst the world-renowned sights of Vienna's majestic Ringstrasse, and at the illuminated Rathaus, Vienna's largest Christmas Market. (B,L,D)

Day 4, MELK. High on a rocky outcrop lies the Melk Abbey, one of Europe's most revered Baroque monasteries. Visit this magnificent Benedictine Abbey, which now houses a museum chronicling its history and a famous library with countless medieval manuscripts. Alternatively, go on a guided bike ride along the Danube and through the scenic Strudengau Valley. (B,L,D)



VIENNA, AUSTRIA

ICONIC CHRISTMAS MARKETS

Day 5, PASSAU, GERMANY. Join a walking tour of this 2,000-year-old city, noted for its Gothic and Italian Baroque architecture and St. Stephen's. Go in search of Bavarian-style crafts at the Christmas Market. Alternatively, you can travel through the serene Austrian Alps to Salzburg, birthplace of Mozart. Your full-day excursion in Salzburg includes a walking tour of the UNESCO-designated Old Town, its magnificent cathedral and Christmas Market, which is a feast for the senses. For the active adventurer, join a guided bike tour along the Danube. (B,L,D)

Day 6, REGENSBURG. Regensburg is one of Germany's best preserved medieval cities, as well as a UNESCO World Heritage Site. Join a guided walking tour showcasing the city's architectural highlights, including the Old Town Hall and the Porta Praetoria before visiting the Old Town Christmas Market. As an alternative, sample some of Bavaria's specialties—beer, sausage and pretzels. Or bike to Walhalla where you will see the neo-Classical white marble temple inspired by the Parthenon in Athens. Later in the day, you'll be treated to one of Bavaria's most beautiful and romantic Christmas Markets at Thurn and Taxis Castle, where you can watch artisans make their unique arts and crafts. (B,L,D)

Day 7, NUREMBERG. Enjoy a scenic morning cruise as the ship crosses the Continental Divide via the Main-Danube Canal to Nuremberg. Join a city tour of WWII highlights and then walk through Nuremberg's cobblestone streets to the Imperial castle and 900-year-old city ramparts. Alternatively, you can taste your way through the city with a Franconian specialties tour, which introduces you to

Bratwurst, Rotbier (red beer) and Lebkuchen (gingerbread). Later, you can visit Nuremberg's Christkindlesmarkt (Christmas Market), one of the world's largest and most famous Christmas Markets. Stroll along as the aroma of mulled wine and gingerbread fill the air and browse through over 100 red and white canvas-topped booths offering an assortment of unique treasures, toys and seasonal goodies. (B,L,D)

Day 8, DISEMBARKATION – NUREMBERG. Disembark after breakfast and prepare for your journey home. (B)

LAND PROGRAMME OPTIONS – POST-CRUISE

PRAGUE – 2 NIGHTS

Take a scenic drive through the Bohemian countryside as you transfer to Prague. The fairytale city of Prague always enchants, but it really sparkles even more during the holiday season. Prague offers a collection of Art Nouveau, Baroque, Renaissance and Gothic architecture, which you'll get to see on your tour. You will see Rudolfinum, the National Museum, Wenceslas Square and the Dancing House, as well as visit 1,000 year-old Prague Castle and St. Vitus before walking over the romantic Charles Bridge to the Old Market Square, where you will find the capital's famous Astronomical Clock, Tyn Church and the statue of Jan Husk.



BE TEMPTED BY LOCAL CUISINE



SHOPPING FOR FESTIVE GIFTS

DATES AND FARES (£)

EMBARK DATE	START CITY	SHIP NAME	7-NIGHT CRUISE
Nov 23	Nuremberg	AmaViola	£2,045
Nov 25	Nuremberg	AmaLea	£2,045
Nov 30	Budapest	AmaViola	£2,045
Dec 02	Budapest	AmaLea	£2,045
Dec 07	Nuremberg	AmaViola	£2,045
Dec 09	Nuremberg	AmaLea	£2,045
Dec 14	Budapest	AmaViola	£2,045
Dec 14	Nuremberg	AmaSerena	£2,045
Dec 21	Budapest	AmaSerena	£1,978
Dec 21	Nuremberg	AmaViola	£2,045

■ Itinerary is slightly modified; visit www.amawaterways.co.uk for detailed itinerary.

Most Christmas Markets open during the last week of November until approximately Dec 22. Check with each country's tourist office for more information.

Flights: Please call for fares and availability.

Transfers: Budapest Airport to Ship (or reverse): from £20 per person. Ship to Nuremberg Airport (or reverse): from £24 per person.

Cruise fares are per person based on double occupancy in a Cat. E, deluxe outside stateroom with window. To upgrade to a higher category, add per person:

CAT.	DECK	STATEROOM	ADD'L
D	Piano	Window	£199
CB	Violin	French Balcony	£399
CA/C	Violin & Cello	French Balcony	£599
BB	Cello	French/Outside Balcony	£933
BA	Violin	French/Outside Balcony	£1,066
AB	Cello	French/Outside Balcony	£1,199
AA	Violin	French/Outside Balcony	£1,333
AA+	Violin	French/Outside Balcony	£1,733
Suite	Violin	French/Outside Balcony	£2,199

Port Charges: Fares include port charges of £112 per person

Single Supplement: Categories E – AA: add 50% per person; Categories AA+ and Suite: add 100% per person. Single supplement may be waived on D and E categories subject to availability. Please check at time of booking.

Bedding: Please select bedding configuration at the time of booking.

Option A: Two twin beds

Option B: One large bed (larger than queen size)

Deck Plans: AMALEA & AMAVIOLA – See page 164

AMASERENA – See page 166

LAND PROGRAMMES

POST-CRUISE – 2 NIGHTS PRAGUE from £347 per person

Additional Hotel Nights (prices subject to change due to seasonality):

Prices are per person

Prague: Double occupancy – £94, Single occupancy – £187

Budapest: Double occupancy – £100, Single occupancy – £200

Nuremberg: Double occupancy – £147, Single occupancy – £294

Upgrade to the Four Seasons in Prague is available; ask for details.

Additional hotel nights include portage, breakfast, as well as transfers to/from the ship only in cities where the ship is embarking or disembarking.

Single Supplement: 2 Nights Prague £213 per person

For more information on hotels, please see page 42.

THE DANUBE RIVER



PRAGUE, CZECH REPUBLIC

MAGICAL CHRISTMAS MARKETS

7 NIGHTS • NUREMBERG TO VIENNA (OR REVERSE)

EXPERIENCE COLOURFUL LOCAL TRADITIONS IN PICTURESQUE TOWNS WHERE MANY BELOVED CHRISTMAS TRADITIONS ORIGINATED



Few events are awaited with as much anticipation as Europe's Christmas Markets. Be spellbound by Nuremberg and Regensburg's Christmas Markets. In Linz, marvel at the small clay figurines representing the people of a typical village—the butcher, the baker and the candlestick maker; and while in Vienna, visit four Christmas Markets. Embrace the holiday spirit in Germany and Austria where many Christmas traditions began on this magical journey through time.



SWEET CHRISTMAS TREATS



NUREMBERG, GERMANY

DAILY PROGRAMME FEATURES

DAY	DESTINATION	ACTIVITIES
1	Nuremberg, Germany	✳ EMBARKATION
2	Nuremberg, Germany	City tour Nuremberg Christmas Market Cruise Main-Danube Canal
3	Regensburg, Germany	Scenic cruising Walking tour OR Bavarian specialties tasting OR Walhalla bike tour Thurn and Taxis Royal Christmas Market
4	Passau, Germany	Walking tour and Christmas Market OR Passau bike tour
5	Linz, Austria	Walking tour OR Full-day Salzburg OR Castle and "Culture Mile" bike tour Half-day Salzburg OR Český Krumlov
6	Melk, Austria Wachau Valley Dürnstein, Austria Krems, Austria	Benedictine Abbey tour OR Danube bike tour Scenic cruising OR Melk to Dürnstein bike tour Walking tour and wine tasting OR Apricots and Sweets tasting Wine tasting OR Evening walk
7	Vienna, Austria	Morning city tour with Town Hall Christmas Market OR Alte Donau bike tour Artisans and Schönbrunn Palace Christmas Markets
8	Vienna	⚓ DISEMBARKATION

✳ Embark 7-Night Cruise

⚓ Disembark 7-Night Cruise

Note: Bike tours and hikes subject to weather and seasonality.

For full itinerary details, visit www.amawaterways.co.uk

INCLUDED FEATURES

- » 7 nights deluxe cruise accommodation in an outside stateroom - most staterooms and suites offer revolutionary twin balconies
- » Entertainment-On-Demand in all staterooms featuring free high-speed internet access, movies, a music library and English language TV stations
- » Fine dining, including unlimited complimentary hand-selected wines, beer and soft drinks with lunch and dinner on board
- » Multiple dining venues, including The Chef's Table specialty restaurant featuring our unique tasting menu
- » **NEW FOR 2018 - Sip & Sail daily cocktail hour with complimentary wine, beer, spirits and soft drinks**
- » Welcome Cocktail, Welcome Dinner, La Chaîne des Rôtisseurs Dinner, Captain's Cocktail and Gala Dinner
- » Complimentary Wi-Fi access on board
- » Guided shore excursions in every port, including Special Interest Tours, hiking and biking tours
- » Onboard live entertainment, theme dinners, cooking demonstration and more
- » Complimentary bicycles, helmets and Nordic walking sticks
- » Services of a professionally trained Cruise Manager throughout your cruise and land stay
- » Transfers between hotel and ship are included with the purchase of cruise and land package

YOUR ITINERARY

Day 1, EMBARKATION - NUREMBERG, GERMANY. Meet your fellow travellers at a Welcome Dinner. The ship will moor overnight in Nuremberg. (D)

Day 2, NUREMBERG. Join a city tour of WWII highlights and then walk through Nuremberg's cobblestone streets to the Imperial Castle and 900-year-old city ramparts. Visit Nuremberg's Christkindlesmarkt, one of the world's largest and most famous Christmas Markets. Browse through over 100 red and white canvas-topped booths offering an assortment of unique treasures, toys and seasonal goodies. Later in the day, cruise through the man-made marvel, the Main-Danube Canal. (B,L,D)

Day 3, REGENSBURG. Regensburg is one of Germany's best preserved medieval cities, as well as a UNESCO World Heritage Site. Join a guided walking tour showcasing the city's architectural highlights, including the Old Town Hall and the Porta Praetoria, before visiting the Old Town Christmas Market. As an alternative, sample some of Bavaria's specialties—beer, sausage and pretzels. Or bike to Walhalla where you will see the Neoclassical white marble temple inspired by the Parthenon in Athens. Later in the day, you'll be treated to one of Bavaria's most beautiful and romantic Christmas Markets at Thurn

and Taxis Castle, where you can watch craftsmen make their unique arts and crafts. (B,L,D)

Day 4, PASSAU. Picturesque Passau, a fairytale city founded more than 2,000 years ago is noted for its Gothic and Italian Baroque architecture. During the season of Advent, the city dresses in her Bavarian holiday splendour, which you will discover on your walking tour through the city and at its Christmas Market at St. Stephen's Square— also home to its magnificent cathedral. Go in search of unique crafts, including Bavarian-style houses and glass ornaments. If you prefer a more active adventure, join a guided bike ride along the Danube. (B,L,D)

Day 5, LINZ. Linz is known for being the city of Christmas Nativities and its ever popular Linzer Torte. While here, you have a choice of three excursions. The first is a full-day visit to magnificent Salzburg dressed in her holiday best. Enjoy a walking tour of UNESCO-designated Old Town, its magnificent cathedral, inspired by St. Peter's Cathedral at the Vatican and its Christmas Market, which is a feast for the senses. Alternatively, you can choose a morning walking tour through Linz's old city centre and by the Mozart House, where he composed the



SHOP FOR HANDCRAFTED ORNAMENTS

MAGICAL CHRISTMAS MARKETS

Linz Symphony in only three days, as well as visit Linz's Christmas Markets. Or you can go on a guided bike tour through Linz and along the city's famed "Culture Mile" and the Danube. During the afternoon, you can join a half-day excursion to Salzburg or visit the charming mountain town, Český Krumlov, located just over the Czech-Austrian border. (B,L,D)

Day 6, MELK – DÜRNSTEIN – KREMS. The magnificent Benedictine Abbey, a UNESCO World Heritage Site is on full display for your enjoyment. On your tour, you will see jewel-encrusted crosses containing religious relics, frescoes and richly embroidered vestments, as well as the abbey's priceless collection of medieval manuscripts in its famous library. Later in the day, set sail through the breathtaking Wachau Valley. (B,L,D)

Day 7, VIENNA. The "City of Waltzes" offers a treasure trove of gems just waiting to be discovered. Join a tour showcasing its regal splendours, such as the majestic Opera House and the former Imperial Palace of the Habsburgs before concluding in Vienna's historic city centre. Afterwards, you'll visit the Rathaus (Town Hall) Christmas Market. If you prefer a more active adventure, then join a guided bike ride along the Danube. During the afternoon, visit the Karlsplatz (Artisans) Christmas Market, a local favourite, and the market at Schönbrunn Palace with a giant sparkling Christmas tree. (B,L,D)

Day 8, DISEMBARKATION – VIENNA. Disembark the ship and prepare for your journey home. (B)



TRADITIONAL CHRISTMAS MARKET, VIENNA, AUSTRIA

LAND PROGRAMME OPTIONS – PRE-CRUISE

PRAGUE – 2 NIGHTS

The fairytale city of Prague always enchants, but it really sparkles even more during the holiday season. See all the key highlights on a walking tour, including the National Museum and 1,000 year-old Prague Castle. Or get more active with a hike to the castle. Drive through the pastoral countryside to Nuremberg where you'll visit to one of the town's Christmas Markets.

LAND PROGRAMME OPTIONS – POST-CRUISE

VIENNA – 2 NIGHTS

Uncover "Vienna's Royal Treasures" at the Hofburg Palace, the former residence of the Habsburgs. You'll visit the lavishly decorated Imperial Apartments and Imperial Treasury, home to many of the Habsburg's treasures, including the Crown of the Holy Roman Empire and the Austrian Imperial Crown. Cap the day off with "Vienna by Night" Christmas Markets at the beautifully decorated Maria Theresaplatz Christmas Market, set amongst the world-renowned sights of Vienna's majestic Ringstrasse, and at the illuminated Rathaus, Vienna's largest Christmas Market.



ONE-OF-A-KIND TREASURES

DATES AND FARES (£)

EMBARK DATE	START CITY	SHIP NAME	7-NIGHT CRUISE
Nov 23	Vienna	AmaSerena	£2,045
Nov 24	Vienna	AmaCerto	£2,045
Nov 25	Vienna	AmaSonata	£2,045
Nov 30	Nuremberg	AmaSerena	£2,045
Dec 01	Nuremberg	AmaCerto	£2,045
Dec 02	Nuremberg	AmaSonata	£2,045
Dec 07	Vienna	AmaSerena	£2,045
Dec 08	Vienna	AmaCerto	£2,045
Dec 09	Vienna	AmaSonata	£2,045
Dec 15	Nuremberg	AmaCerto	£2,045
Dec 16	Nuremberg	AmaSonata	£2,045
Dec 22	Vienna	AmaCerto	£2,045
Dec 23	Vienna	AmaSonata	£2,045

Flights: Please call for fares and availability.

Transfers: Ship to Vienna Airport (or reverse): from £20 per person. Nuremberg Airport to ship (or reverse): from £24 per person.

Most Christmas Markets open during the last week of November until approximately Dec 22. Check with each country's tourist office for more information.

Cruise fares are per person based on double occupancy in a Cat. E, deluxe outside stateroom with window. To upgrade to a higher category, add per person:

CAT.	DECK	STATEROOM	ADD'L
D	Piano	Window	£199
C	Violin & Cello	French Balcony	£599
BB	Cello	French/Outside Balcony	£933
BA	Violin	French/Outside Balcony	£1,066
AB	Cello	French/Outside Balcony	£1,199
AA	Violin	French/Outside Balcony	£1,333
AA+	Violin	French/Outside Balcony	£1,733
Suite	Violin	French/Outside Balcony	£2,199

Port Charges: Fares include port charges of £112 per person

Single Supplement: Categories E – AA: add 50% per person; Categories AA+ and Suite: add 100% per person. Single supplement may be waived on D and E categories subject to availability. Please check at time of booking.

Bedding: Please select bedding configuration at the time of booking.

Option A: Two twin beds

Option B: One large bed (larger than queen size)

Deck Plans: AMACERTO, AMASERENA & AMASONATA – See page 166.

LAND PROGRAMMES

PRE-CRUISE – 2 NIGHTS PRAGUE from £347 per person

POST-CRUISE – 2 NIGHTS VIENNA from £347 per person

Additional Hotel Nights (prices subject to change due to seasonality):

Prices are per person

Prague: Double occupancy – £94, Single occupancy – £187

Vienna: Double occupancy – £90, Single occupancy – £180

Nuremberg: Double occupancy – £147, Single occupancy – £294

Upgrade to the Four Seasons in Prague is available; ask for details.

Additional hotel nights include portage, breakfast, as well as transfers to/from the ship only in cities where the ship is embarking or disembarking.

Single Supplement:

2 Nights Prague £213 per person **2 Nights Vienna** £213 per person

For more information on hotels, please see page 42.

THE RHINE RIVER



CHRISTMAS MARKET, STRASBOURG

CHRISTMAS MARKETS ON THE RHINE

7 NIGHTS • AMSTERDAM TO BASEL (OR REVERSE)

NORTHERN EUROPE'S GLITTERING FESTIVE MARKETS AWAIT ON THIS CRUISE DOWN THE RHINE



Experience the deep-rooted holiday traditions of Europe at its most festive time of year. Cologne's Christmas Market with its impressive Gothic cathedral backdrop; the "Capital of Noël," Strasbourg, with its magnificent great Christmas tree; and Heidelberg's Christmas Market nestled idyllically amongst the historic squares of the Old Town; are all timeless traditions handed down through the centuries. Cherish all the glory of the season in grand European style as you cruise along the Rhine.



MAKE HOLIDAY MEMORIES



LUCERNE'S CHAPEL BRIDGE, SWITZERLAND

DAILY PROGRAMME FEATURES

DAY	DESTINATION	ACTIVITIES
1	Amsterdam, The Netherlands	EMBARKATION
2	Amsterdam	Canal cruise and city tour Scenic cruising
3	Cologne, Germany	City tour, cathedral and Christmas Market OR Kölsch beer tasting OR Cologne bike tour
4	Rüdesheim, Germany	Wine tasting OR Gondola ride OR Rheingau bike tour Christmas Market Siegfried's Mechanical Music Museum OR Rudesheimer coffee
5	Mannheim, Germany	Heidelberg excursion and Christmas Market OR Medieval Speyer and Christmas Market
6	Strasbourg, France Gengenbach, Germany	City tour and Christmas Market OR Old Town bike tour Christmas Market
7	Breisach, Germany	Riquewihr walking tour and Christmas Market OR Freiburg excursion with Christmas Market OR Breisach bike tour
8	Basel, Switzerland	DISEMBARKATION

Embark 7-Night Cruise

Disembark 7-Night Cruise

Note: Bike tours and hikes subject to weather and seasonality.

For full itinerary details, visit www.amawaterways.co.uk

INCLUDED FEATURES

- » 7 nights deluxe cruise accommodation in riverview stateroom or suite – most staterooms and suites offer twin balconies
- » Entertainment-On-Demand in all staterooms featuring free high-speed internet access, movies, a music library and English language TV stations
- » Fine dining, including unlimited complimentary hand-selected wines, beer and soft drinks with lunch and dinner on board
- » Multiple dining venues, including The Chef's Table specialty restaurant featuring our unique tasting menu
- » **NEW FOR 2018 – Sip & Sail daily cocktail hour with complimentary wine, beer, spirits and soft drinks**
- » Welcome Cocktail, Welcome Dinner, La Chaîne des Rôtisseurs Dinner, Captain's Cocktail and Gala Dinner
- » Complimentary Wi-Fi access on board
- » Guided shore excursions in every port, including Special Interest Tours, hiking and biking tours
- » Onboard live entertainment, theme dinners, cooking demonstration and more
- » Complimentary bicycles, helmets and Nordic walking sticks
- » Services of a professionally trained Cruise Manager throughout your cruise and land stay
- » Transfers between hotel and ship are included with the purchase of cruise and land package

YOUR ITINERARY

Day 1, EMBARKATION – AMSTERDAM, THE NETHERLANDS. Arrive in Amsterdam and board your luxurious river cruise ship. (D)

Day 2, AMSTERDAM. Begin your discovery of Amsterdam with a scenic canal cruise, followed by a walking tour to the Begijnhof, known for its historic Middle Ages building and concluding with a panoramic city tour that includes the Royal Palace and Westerkerk. Later in the day, set sail. (B,L,D)

Day 3, COLOGNE. Enjoy cruising to Cologne, home to one of Germany's most revered Gothic masterpieces, the Cologne Cathedral. Join a guided tour through the enchanting Old Town. Explore the UNESCO-designated cathedral and then visit one of Europe's largest and most renowned Christmas Markets located in front of the cathedral. Alternatively, ride a bike along the Rhine and through the historic Stadtgarten; or visit a local tavern to taste Cologne's traditional Kölsch beer and Reibekuchen—potato pancakes served with apple sauce. (B,L,D)

Day 4, RHINE GORGE – RÜDESHEIM. Cruise through the castle-laden Rhine River Gorge before reaching the winemaking town of Rüdesheim. Once in Rüdesheim, you will have three choices of morning excursions. Wine connoisseurs will want to go to a wine cellar for a wine tasting. Those who wish to soar high above the vineyards

can take a gondola ride to the Niederwalddenkmal Statue. Or, for a more active adventure, join a guided bike tour through the town and along the Rhine River. Later in the day, you have two more options. Visit Siegfried's Mechanical Music Museum, home to a remarkable collection of self-playing musical instruments; or taste one of the town's special delights, Rüdeshheimer coffee. You'll also have plenty of time to enjoy Christmas traditions from all over the world at Rüdesheim Christmas Market. (B,L,D)

Day 5, MANNHEIM. You have the choice to explore two of Germany's historically rich cities, along with their festive Christmas Markets. Visit Heidelberg, a city that will capture your heart with its mighty castle and historic university. While here, wander along one of Europe's longest pedestrian shopping streets, the Hauptstrasse, soaking up the Yuletide celebrations at the town's Christmas Markets. Alternatively, you can explore one of Germany's oldest cities, Speyer, known for the largest Romanesque cathedral in Europe—a UNESCO World Heritage Site. You'll also have time to visit its Christmas Market in front of the "Old Mint" (Alten Münze) in the famous Maximilianstrasse, with a view of the romantic imperial cathedral (Kaiserdom). (B,L,D)

Day 6, STRASBOURG. Strasbourg is even more alluring during the season of Advent. The Christkindelsmärik dates back to 1570, making it the oldest Christmas Market



EXPERIENCE A WINTER WONDERLAND

CHRISTMAS MARKETS ON THE RHINE

in France. Enjoy a panoramic bus tour that takes you past the Parc de l'Orangerie, the European Parliament and the Place de la Republique. Afterwards, walk through the historic town centre on the Grande Île, a UNESCO World Heritage Site, and through the lovely "La Petite France" district, where you will see the Cathédrale de Nôtre Dame with its famous astronomical clock and then visit the town's famous Christmas Market. You can also choose to explore Strasbourg's different districts by bicycle. During the afternoon, visit Gengenbach Christmas Market where every year the locals countdown to Christmas with a 24-day, larger-than-life Advent calendar. (B,L,D)

Day 7, BREISACH. Visit the enchanting Alsatian town of Riquewihr beautifully dressed in her holiday finery with twinkling decorations and a lively Christmas Market. On your walking tour, admire historical architecture, as well as famous sights, such as the Dolder Gate. Alternatively, you may wish to go to two other gems. Visit Freiburg, founded in 1120, and home to Freiburg's Münster, a Gothic cathedral constructed of red sandstone, as well as an enchanting Christmas Market. Those wishing a more active excursion will want to cycle through the scenic countryside. (B,L,D)

Day 8, DISEMBARKATION – BASEL. Disembark after breakfast and prepare for your journey home. (B)

LAND PROGRAMME OPTIONS – POST-CRUISE

SWITZERLAND – 4 NIGHTS

Visit the Lion Monument, built to honour the Swiss Guards who fought for King Louis XVI during the French Revolution. You'll then get acquainted with the city on a walking tour along with a visit to the Christmas Market. Soak up the festive atmosphere of this medieval gem situated on Lake Lucerne. Experience the magic of Zurich dressed in her holiday best and join a walking tour followed by a visit to the Christmas Markets, including the largest indoor Christmas Market in Europe. Located in Zurich's Main Train Station, an absolute highlight is a 50-foot-tall Christmas tree decorated with thousands of sparkling Swarovski crystals.

TREASURES OF THE MAIN & RHINE

7-NIGHT CRUISE FROM NUREMBERG TO AMSTERDAM

NUREMBERG · BAMBERG · KITZINGEN · WÜRZBURG · WERTHEIM · RÜDESHEIM · COLOGNE · AMSTERDAM



CHRISTMAS MARKET IN NUREMBERG, GERMANY

EMBARK DATE	START CITY	SHIP NAME	7-NIGHT CRUISE
2017 Dec 27	Nuremberg	AmaStella	£1,845
2018 Dec 28	Nuremberg	AmaSerena	£1,845

Port Charges: Additional £112 per person

Single Suppl. for Cruise: 50% of twin price; AA+ and Suites 100% of twin price

Single Suppl. for Pre-Cruise Land Arrangements: £213 per person

For upgrade charges, refer to chart on the right.

DATES AND FARES (£)

EMBARK DATE	START CITY	SHIP NAME	7-NIGHT CRUISE
Nov 24	Basel	AmaPrima	£2,045
Nov 26	Amsterdam	AmaKristina	£2,045
Nov 26	Basel	AmaStella	£2,045
Dec 01	Amsterdam	AmaPrima	£2,045
Dec 03	Basel	AmaKristina	£2,045
Dec 03	Amsterdam	AmaStella	£2,045
Dec 08	Basel	AmaPrima	£2,045
Dec 10	Amsterdam	AmaKristina	£2,045
Dec 10	Basel	AmaStella	£2,045
Dec 15	Amsterdam	AmaPrima	£2,045
Dec 17	Basel	AmaKristina	£2,045
Dec 17	Amsterdam	AmaStella	£2,045
Dec 24	Amsterdam	AmaKristina	£2,045
Dec 24	Basel	AmaStella	£2,045

Flights: Please call for fares and availability.

Transfers: Amsterdam Airport to Ship (or reverse): from £20 per person. Ship to Basel Airport (or reverse): from £40 per person.

Most Christmas Markets open during the last week of November until approximately Dec 22. Check with each country's tourist office for more information.

Cruise fares are per person based on double occupancy in a Cat. E, deluxe outside stateroom with window. To upgrade to a higher category, add per person:

CAT.	DECK	STATEROOM	ADD'L
D	Piano	Window	£199
CB	Violin	French Balcony	£399
CA/C	Violin & Cello	French Balcony	£599
BB	Cello	French/Outside Balcony	£933
BA	Violin	French/Outside Balcony	£1,066
AB	Cello	French/Outside Balcony	£1,199
AA	Violin	French/Outside Balcony	£1,333
AA+	Violin	French/Outside Balcony	£1,733
Suite	Violin	French/Outside Balcony	£2,199

Port Charges: Fares include port charges of £112 per person

Single Supplement: Categories E – AA: add 50% per person; Categories AA+ and Suite: add 100% per person. Single supplement may be waived on D and E categories subject to availability. Please check at time of booking.

Bedding: Please select bedding configuration at the time of booking.

Option A: Two twin beds

Option B: One large bed (larger than queen size)

Deck Plans: AMAKRISTINA & AMASTELLA – See page 164.

AMAPRIMA – See page 166.

LAND PROGRAMMES

POST-CRUISE – 4 NIGHTS SWITZERLAND from £1,120 per person

Additional Hotel Nights (prices subject to change due to seasonality):

Prices are per person

Amsterdam: Double occupancy – £180, Single occupancy – £360

Zurich: Double occupancy – £167, Single occupancy – £334

Basel: Double occupancy – £234, Single occupancy – £467

Additional hotel nights include portage, breakfast, as well as transfers to/from the ship only in cities where the ship is embarking or disembarking.

Single Supplement: 4 Nights Switzerland £427 per person

For more information on hotels, please see page 42.

THE EXOTICS

SOUTHEAST ASIA AND AFRICA

Walk the path less travelled. Discover the magic and beauty of a distant land. See the world through someone else's eyes.



EXOTICS AT-A-GLANCE

ITINERARY / START & END CITIES	PAGE	NO. OF NIGHTS	SHIPS	RIVERS	LAND PROGRAMMES	COUNTRIES CRUISE & LAND																
							JAN	FEB	MAR	APR	MAY	JUN	JUL	AUG	SEP	OCT	NOV	DEC				
RICHES OF THE MEKONG HANOI TO HO CHI MINH CITY	144	15	AmaDara	Mekong	Hanoi Ha Long Bay Siem Reap Ho Chi Minh City	Vietnam Cambodia																
CHARMS OF THE MEKONG NEW HO CHI MINH CITY TO HANOI	148	15	AmaDara	Mekong	Ho Chi Minh City Siem Reap Hanoi Ha Long Bay	Vietnam Cambodia																
DISCOVER AFRICA CAPE TOWN TO JOHANNESBURG	154	9	Zambezi Queen	Chobe	Cape Town Victoria Falls	South Africa Zimbabwe																
RIVERS & RAILS OF AFRICA CAPE TOWN TO JOHANNESBURG	156	12	Zambezi Queen	Chobe	Cape Town Victoria Falls Johannesburg	South Africa Zimbabwe																
WILDLIFE & THE FALLS NEW JOHANNESBURG TO JOHANNESBURG	158	12	Zambezi Queen	Chobe	Johannesburg Victoria Falls Kruger Park Area	South Africa Zimbabwe																
STARS OF SOUTH AFRICA CAPE TOWN TO JOHANNESBURG	160	14	Zambezi Queen	Chobe	Cape Town Victoria Falls Johannesburg Kruger Park	South Africa Zimbabwe																
GOLDEN TRAILS OF EAST AFRICA JOHANNESBURG OR CAPE TOWN TO ARUSHA	162	16	Zambezi Queen	Chobe	Johannesburg Victoria Falls Tarangire Ngorongoro Serengeti Arusha	South Africa Zimbabwe Tanzania																

Note: Start and end cities, as well as number of nights reflect cruise and land programmes.



Vietnam & Cambodia - The Chobe

Experience Vietnam and Cambodia on this fabled river, also known as the "Mother of Water." For centuries, the sagas of ancient empires, colonial powers and modern conflicts have unfolded along its banks. To this day, the river serves as a vital lifeline to millions of people, and on our cruises, you will experience a compelling contrast of past and present.

Africa - The Mekong

This scenic and amazing waterway forms the northern boundary of Chobe National Park. It is a rich haven for wildlife, particularly during the dry season from May to October, when water further inland is scarce. Our Africa itineraries, which provide a unique combination of a river cruise and immersive land programme are the ultimate way to experience this must-see part of the world.

OUR EXOTIC SHIPS

Each of our ships in the exotic region was custom-designed to maximise your experience with all the comforts and conveniences for the most memorable journey possible. With spacious staterooms, an array of amenities and impeccable service, a haven for relaxation and rejuvenation will be waiting for you after each day of exploration.

AMADARAVIETNAM & CAMBODIA

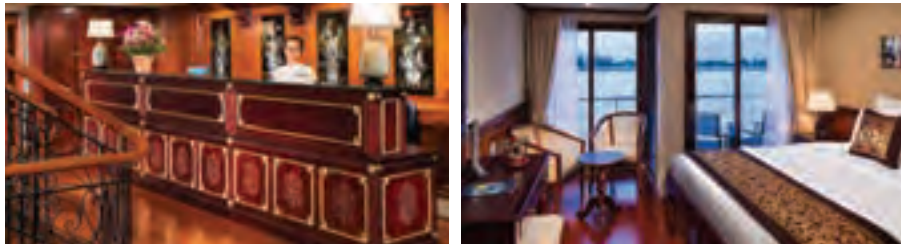

The award-winning AmaDara is in a class unto itself with spacious staterooms, private balconies and convenient interior access. Savour authentic regional delicacies and western cuisine in the main restaurant or dine at The Chef's Table specialty restaurant. A host of amenities ranging from an onboard spa to a swimming pool provides added comforts for guests to enjoy.

- ◆ Staterooms range from 251 to 502 square feet and feature twin balconies – a French balcony and an outside balcony
- ◆ Air-conditioned staterooms, hallways, restaurants and lounge
- ◆ Convenient interior access, unlike most other ships on the river
- ◆ Sun deck pool, spa, hair salon and fitness room
- ◆ Complimentary unlimited wine with every lunch and dinner
- ◆ Complimentary house spirits, local beer, soft drinks and bottled water available during the cruise
- ◆ Vietnamese and Cambodian cuisine as well as traditional Western dishes

ZAMBEZI QUEENAFRICA

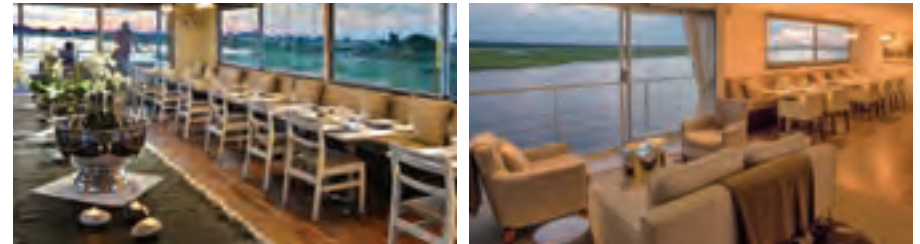

The award-winning, eco-friendly Zambezi Queen was specifically designed to maximise the views along the Chobe River. From the ship, guests are likely to observe elephants, hippos, crocodiles, flocks of birds and other wildlife gathering along the shoreline. With modern accommodations, delicious onboard cuisine and an open-air deck, this vessel offers a one-of-a-kind way to experience Africa.

- ◆ All staterooms are suites that range from 215 to 300 square feet and feature outside balconies
- ◆ Sun deck pool
- ◆ Air-conditioned staterooms, dining room and lounge
- ◆ Convenient interior access
- ◆ Complimentary unlimited wine and beer
- ◆ Regional African cuisine as well as traditional Western dishes

AUTHENTIC EXPERIENCES

VIETNAM & CAMBODIA



SKILLED ARTISANS

Experience local commerce firsthand while watching skilled artisans make popular items, such as mats and slippers, right in front of your eyes.



CAI BE

Visit a Vietnamese rice paper workshop and try your hand at making paper using the traditional method that has been used for centuries.



BUDDHIST BLESSING

In Cambodia's former capital of Oudong, you will have an exclusive opportunity to receive a special Buddhist blessing.

AFRICA



CAPE PENINSULA

Get up close to penguins in beautiful Boulders Beach, one of the few places in the world to see them like this.



CHOBE RIVER & NATIONAL PARK

Be on the lookout for elephants, lions, leopards and more as you safari by boat and 4x4 open-air vehicles in the game-rich Chobe.



BUSHTRACKS EXPRESS

Return to the Golden Age of African rail by boarding a vintage steam train for sweeping views over Victoria Falls.

THE MEKONG RIVER



DAYBREAK AT THE ANGKOR UNESCO WORLD HERITAGE SITE IN CAMBODIA

RICHES OF THE MEKONG

16 DAYS • TRAVEL TO HANOI AND RETURN FROM HO CHI MINH CITY

SPEND 2 NIGHTS IN HANOI, 1 NIGHT IN HA LONG BAY, 3 NIGHTS IN SIEM REAP, 7-NIGHT PREK K DAM TO HO CHI MINH CITY CRUISE AND 2 NIGHTS IN HO CHI MINH CITY

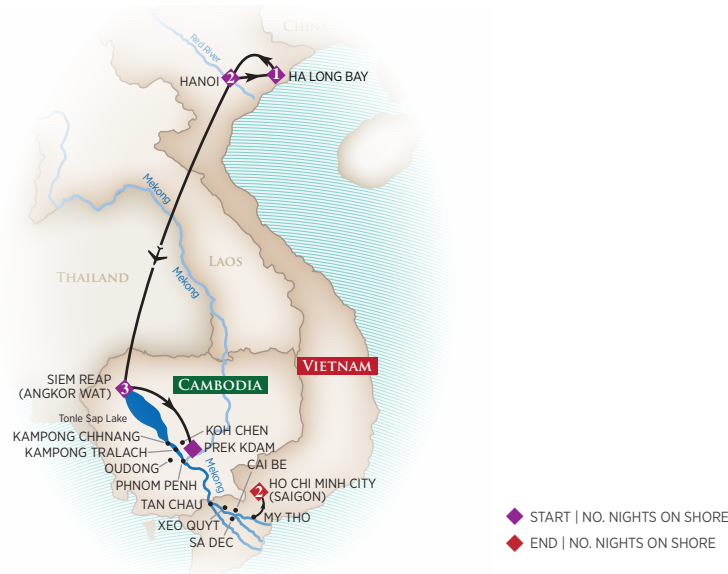

Your journey begins in Vietnam's capital, Hanoi, followed by an excursion to breathtaking Ha Long Bay for an overnight sojourn on board a deluxe junk. A short flight to Siem Reap, Cambodia brings you to the gateway of the ancient Khmer empire where you'll explore the temples of Angkor Archaeological Park. Embark on your Mekong River cruise and visit rural villages, pagodas, local markets and a Buddhist monastery along the way. Conclude your cruise with a two-night stay in lively Ho Chi Minh City.



FRIENDLY LOCALS



HANOI SCENIC LANDSCAPE

DAILY PROGRAMME FEATURES

DAY	DESTINATION	ACTIVITIES
1	Hanoi, Vietnam	Hotel check-in
2	Hanoi	City tour and rickshaw ride Water Puppet Show
3	Hanoi Ha Long Bay, Vietnam	Transfer to Ha Long Bay Bay excursion Overnight cruise aboard a deluxe Junk
4	Ha Long Bay Siem Reap, Cambodia	Transfer to airport Flight to Siem Reap Hotel check-in
5	Siem Reap	Angkor Thom, Ta Prohm and Banteay Srei temples Visit AmaWaterways- sponsored school
6	Siem Reap	Angkor Wat
7	Prek Kdam, Cambodia	✳ EMBARKATION Welcome Dinner
8	Kampong Chhnang, Cambodia Koh Chen, Cambodia	Motor boat excursion into lakeside wetlands Silversmith village visit
9	Oudong, Cambodia Kampong Tralach, Cambodia Phnom Penh, Cambodia	Visit Buddhist monastery Oxcart ride Tuk tuk ride
10	Phnom Penh	Killing Fields and Genocide Museum OR Central Market Royal Palace and National Museum
11	Tan Chau, Vietnam	Border crossing from Cambodia to Vietnam
12	Tan Chau	Trishaw ride to craftsmen's workshops OR Local village
13	Sa Dec, Vietnam Xeo Quyt, Vietnam Cai Be, Vietnam	Local boat ride to Sa Dec Visit local market and temple Xeo Quyt excursion Visit local workshop s OR Kiet historical house
14	Ho Chi Minh City, Vietnam	⚓ DISEMBARKATION (My Tho Port) Transfer to city; City tour
15	Ho Chi Minh City	Free day
16	Ho Chi Minh City	Depart for onward travel

✳ Embark 7-Night Cruise ⚓ Disembark 7-Night Cruise

Note: Itinerary can be booked as cruise-only.

For full itinerary details, visit www.amawaterways.co.uk

INCLUDED FEATURES

- » 2 nights hotel accommodation in Hanoi at the Sofitel Legend Metropole (or similar), including daily buffet breakfast
- » Overnight stay on board a luxurious Junk in Ha Long Bay
- » 3 nights hotel accommodation in Siem Reap at the Sofitel Royal Angkor Phokeethra Golf & Spa Resort (or similar), including daily buffet breakfast
- » 7 nights deluxe cruise accommodation in an outside stateroom, all with twin balconies
- » Immersive excursions and authentic local encounters
- » Fine dining with all meals included during your cruise
- » Unlimited wine with every lunch and dinner on board
- » Complimentary house-brand spirits, local beer and soft drinks during cruise
- » Bottled water in every stateroom replenished daily
- » Welcome Dinner and Farewell Dinner
- » Special highlights on board including folklore dances and music performances, culture discussion forums, theme dinners and music entertainment
- » Non-smoking environment (smoking only permitted in designated areas)
- » 2 nights hotel accommodation in Ho Chi Minh City (Saigon) at the Sofitel Plaza Saigon Plaza (or similar), including buffet breakfast

YOUR ITINERARY

Day 1, ARRIVE IN HANOI, VIETNAM. Hanoi, Vietnam's capital city boasts a rich cultural heritage that blends in harmony with its vibrant present. From ancient temples to French colonial architecture and modern-day skyscrapers, along with beautiful parks and lakes, Hanoi is an eclectic and lively city.

Day 2, HANOI. Discover some of Hanoi's most famous historic and cultural sites on your guided tour that includes: Ba Dinh Square, One Pillar Pagoda and The Temple of Literature. You'll also visit the infamous prison that American POWs sarcastically dubbed the "Hanoi Hilton" during the Vietnam War. Take an authentic rickshaw ride, known as "cyclo," in Hanoi's bustling Old Quarter, and then enjoy a traditional water puppet show. (B)

Day 3, HANOI - HA LONG BAY. Ethereal Ha Long Bay is considered by many to be the eighth Natural Wonder of the World, and AmaWaterways' guests will be treated to this exclusive once-in-a-lifetime experience. Spend the night on board a deluxe Junk, which combines classic beauty with modern conveniences. The backdrop of the bay's magnificent scenery and dramatic limestone cliffs and rock formations provide you with the perfect setting for a memorable dinner. (B,L,D)

Day 4, HA LONG BAY - HANOI - SIEM REAP, CAMBODIA. Spend the morning sailing across the emerald waters of Ha Long Bay with more than 2,000 small islands rising from the water like a dragon's back. Later in the morning, disembark the Junk and transfer to Hanoi Airport for a short flight to Siem Reap, Cambodia, the gateway to

Angkor Archaeological Park, a UNESCO World Heritage Site and the former capital of the Khmer empire. (B,L)

Day 5, SIEM REAP - ANGKOR. Begin your morning exploration of Angkor temple complex at Angkor Thom, meaning "the great city." This is home to Bayon Temple, best known for its gigantic smiling stone faces, as well as the Terrace of the Elephants and the Terrace of the Leper King. You'll then visit nearby Ta Prohm, known as the "Kingdom of Trees," for the way in which the temple stones have become intertwined with thick forest vegetation over the centuries. Afternoon excursions take you to the fascinating jewel in the crown of Angkorian art, Banteay Srei, meaning "Citadel of Women," as it has been said that the carving is too fine to be done by the hand of man. Afterwards, you are in for another treat of a different kind with a visit to the English-language school sponsored by AmaWaterways in the village of Ta Toum. Cap this memorable day off with a special "Apsara Dancing Show" at your hotel, featuring local Cambodian/Khmer folk dancers. (B,D)

Note: The English-language school visit is capacity controlled.

Day 6, SIEM REAP - ANGKOR. Discover the heart and soul of Cambodia and the most iconic of all Angkorian Temples, Angkor Wat, a true masterpiece of Khmer architecture built by King Suryavarman II in the early 12th century to honour the Hindu god, Vishnu. (B,D)

Day 7, SIEM REAP - PREK KHAM - EMBARKATION. Transfer via motor coach to the AmaDara in Prek Kham,



CAMBODIAN APSARA DANCER



TAKE A TRADITIONAL "XE-LOI" RIDE, TAN CHAU, VIETNAM

RICHES OF THE MEKONG

a small village on the Tonle River, for your seven-night cruise. Meet fellow guests at a Welcome Dinner as the ship sails to Kampong Chhnang. (B,L,D)

Day 8, KAMPONG CHHNANG – KOH CHEN. A local motorboat takes you into the lakeside wetlands that form the mouth of Tonle Sap River. Enjoy the stunning variety of bird life here as well as tranquil floating villages. In the afternoon, take a leisurely walk to the small village of Koh Chen, which specialises in silver- and copper-smithing. Get an up-close view of how local artisans make ornamental items often used in traditional ceremonies at a home workshop. (B,L,D)

Day 9, OUDONG – KAMPONG TRALACH – PHNOM PENH. Situated on a picturesque hillside not far from Phnom Penh, lies Oudong, Cambodia's former royal capital. Today, Oudong is a place of pilgrimage for Cambodians. While here, be treated to a memorable Buddhist Blessing Ceremony at a monastery. In Kampong Tralach, you'll have another truly memorable excursion – an oxcart ride through a local village. Later, your ship departs for Phnom Penh, the vibrant colourful capital of Cambodia. Experience Phnom Penh via an authentic tuk tuk ride and be enchanted by the city's French colonial architecture and tree-lined boulevards set amidst monumental Angkorian architecture. During the evening on board, enjoy a typical Khmer folk performance presented by local children. (B,L,D)

Day 10, PHNOM PENH. You will have a choice of excursions this morning. Visit Cambodia's infamous Killing Fields and the Khmer Rouge's grim Tuol Sleng S21 detention centre (Genocide Museum) just outside the city. Or if you prefer to stay in Phnom Penh, you can visit the bustling yellow-coloured Central Market. After lunch on board, you'll explore the highlights of the city, followed by the Royal Palace, the spectacular Silver Pagoda and the National Museum, which has an outstanding collection of Khmer crafts. After returning to the ship, enjoy Khmer folk dancing performed by local children in the Saigon Lounge. (B,L,D)

Day 11, PHNOM PENH – BORDER CROSSING – TAN CHAU, VIETNAM. Spend the day cruising the Mekong River as your ship crosses the border into Vietnam. (B,L,D)

Day 12, TAN CHAU – SA DEC. Enjoy a visit to Tan Chau, a small Mekong River town unspoiled by tourism. Take a boat ride through the narrow channels of the Mekong River to several scenic locations, including a small village known as "Evergreen Island." Return to

Tan Chau, where you will visit a workshop that makes rattan mats. You may opt to take a traditional "xe-loi" (trishaw) ride around the town, with stops at artisans' workshops, such as a silk-making workshop. (B,L,D)

Day 13, SA DEC – XEO QUYT – CAI BE. Once ashore in Sa Dec, tour the town where French writer Marguerite Duras spent many years in her youth. Visit a colourful local market, Cao Dai Temple and the 19th-century house of Mr. Huynh Thuy Le, Duras' Chinese paramour. Later, board a coach for Xeo Quyt, once used as a base during the French and U.S. wars and now an important ecological site. You will have an opportunity to visit candy and rice paper making workshops, or alternatively, visit the historic Kiet Old House. Cap the day off with a festive Farewell Dinner on board. (B,L,D)

Day 14, HO CHI MINH CITY – DISEMBARKATION. Disembark the AmaDara in My Tho Port and transfer to Ho Chi Minh City. Vietnam's former capital of Indochina was once known as "Paris of the Orient," and today, it is an industrial, cultural and educational hub. Explore such famous landmarks as the former Presidential Palace, the Central Post Office, Notre Dame Cathedral and the War Remnants Museum before visiting the Ben Thanh Market—one of the oldest and most iconic structures in Ho Chi Minh City. (B,L)

Day 15, HO CHI MINH CITY. Spend a day at leisure exploring more of Ho Chi Minh City, or perhaps go in search for local handicrafts, colourful textiles, as well as other souvenirs. (B)

Day 16, DEPART HO CHI MINH CITY. Bid farewell to Vietnam as you prepare for your homeward flight. (B)

OTHER ITINERARY OPTIONS – 10 NIGHTS

You can also discover the Mekong and the stunning sites of Vietnam & Cambodia in less time with one of our shorter itineraries. Start in Siem Reap for 3 nights, allowing you to both explore the culture and history of the city at your own leisure, and also discover more with a range of excursions to temples and historic sites in the area. After checking out transfer to the AmaDara for your 7 night river cruise from Prek Kdam to Ho Chi Minh City, Vietnam's largest city.

For full details on this itinerary visit www.amawaterways.co.uk

DATES AND FARES (£)

HOTEL CHECK IN*	START CITY	SHIP NAME	10-NIGHT CRUISE & LAND	15-NIGHT CRUISE & LAND
2017				
Dec 26	Prek Kdam	AmaDara	£2,706	£3,639
2018				
Jan 09	Prek Kdam	AmaDara	£2,706	£3,639
Jan 23	Prek Kdam	AmaDara	£2,706	£3,639
Feb 06	Prek Kdam	AmaDara	£2,706	£3,639
Feb 20	Prek Kdam	AmaDara	£2,706	£3,639
Mar 06	Prek Kdam	AmaDara	£2,640	£3,573
Mar 20	Prek Kdam	AmaDara	£2,506	£3,439
Apr 03	Prek Kdam	AmaDara	£2,373	£3,306
Apr 17	Prek Kdam	AmaDara	£2,240	£3,173
Aug 07	Prek Kdam	AmaDara	£2,173	£3,106
Aug 21	Prek Kdam	AmaDara	£2,240	£3,173
Sep 04	Prek Kdam	AmaDara	£2,373	£3,306
Sep 18	Prek Kdam	AmaDara	£2,506	£3,439
Oct 02	Prek Kdam	AmaDara	£2,640	£3,573
Oct 16	Prek Kdam	AmaDara	£2,640	£3,573
Oct 30	Prek Kdam	AmaDara	£2,640	£3,573
Nov 27	Prek Kdam	AmaDara	£2,640	£3,573
Dec 11	Prek Kdam	AmaDara	£2,640	£3,573
Dec 25	Prek Kdam	AmaDara	£2,640	£3,639
2019				
Jan 08	Prek Kdam	AmaDara	£2,706	£3,639
Jan 22	Prek Kdam	AmaDara	£2,706	£3,639
Feb 05	Prek Kdam	AmaDara	£2,706	£3,639
Feb 19	Prek Kdam	AmaDara	£2,706	£3,639
Mar 05	Prek Kdam	AmaDara	£2,640	£3,573
Mar 19	Prek Kdam	AmaDara	£2,506	£3,439
Apr 02	Prek Kdam	AmaDara	£2,373	£3,306
Apr 16	Prek Kdam	AmaDara	£2,240	£3,173

*Hotel Check In date is based on 15 Night package, please call for alternative start dates.

Flights: Please call for fares and availability.

Transfers: Saigon Airport to Ho Chi Minh City Hotel: from £20 per person.
Siem Reap Hotel to Siem Reap Airport: from £20 per person.
Hanoi Hotel to Hanoi Airport: from £20 per person.

Cruise fares are per person based on double occupancy in a Cat. C, deluxe outside stateroom with window.

To upgrade to a higher category, add per person:

CAT.	DECK	STATEROOM	ADD'L
B	Sadec, Saigon & Tonle	French & Outside Balcony	£399
A	Saigon	French & Outside Balcony	£599
Suite (S)	Sadec	French & Outside Balcony	£933
Luxury Suite (L)	Sadec	French & Outside Balcony	£1,799

Port Charges: Fares include port charges of £107 per person

Single Supplement: Categories C-A add: 50% per person;
Suite: add 75% per person; Luxury Suite: add 100% per person.

Intra-Asia Air (Hanoi-Siem Reap):

£240 per person including taxes and fuel surcharges is included in the 15 Night Cruise Fare

Bedding: Please call for details

Deck Plans: AMADARA – See page 172.

Single Supplement Pre- and Post-Cruise Land Arrangements:
15 Nights £733 per person **10 Nights** £266 per person

Visa: For visa information, please refer to page 176

Please note that the docking process may involve narrow walkways, local tender boats or dirt-covered paths.

THE MEKONG RIVER



CHARMS OF THE MEKONG

16 DAYS • TRAVEL TO HO CHI MINH CITY AND RETURN FROM HANOI

SPEND 2 NIGHTS IN HO CHI MINH CITY, 7-NIGHT HO CHI MINH CITY TO PREK K DAM CRUISE, 2 NIGHTS IN SIEM REAP, 3 NIGHTS IN HANOI AND 1 NIGHT IN HA LONG BAY



Two lively cities, Ho Chi Minh City and Hanoi, provide the perfect start and end to your incredible journey. Cruise along the Mekong, visiting rural villages, historic pagodas, local markets and a Buddhist monastery where you'll be treated to a special blessing by monks. Indulge your inner adventurer in Siem Reap, exploring the grand temples of Angkor Archaeological Park. And be treated to an AmaWaterways' exclusive with an overnight sojourn on board a deluxe Junk in Ha Long Bay.



BAYON TEMPLE, ANGKOR, CAMBODIA



THE MEKONG BUSTLES WITH ACTIVITY

DAILY PROGRAMME FEATURES

DAY	DESTINATION	ACTIVITIES
1	Ho Chi Minh City, Vietnam	Hotel check-in
2	Ho Chi Minh City	City tour
3	Ho Chi Minh City	EMBARKATION (My Tho Port) Welcome Dinner
4	Cai Be, Vietnam	Local boat ride Visit local workshops OR Kiet historic house
	Sa Dec, Vietnam	Local boat ride to Sa Dec Visit to local market and temple
5	Tan Chau, Vietnam	Visit craftsmen's workshops and village Trishaw ride
	Border Crossing	Border Crossing from Vietnam to Cambodia
6	Phnom Penh, Cambodia	Killing Fields and Genocide Museum National Museum and Royal Palace
7	Phnom Penh	Tuk tuk ride OR Central Market Silversmith village visit
	Koh Chen, Cambodia	
8	Oudong, Cambodia	Visit Buddhist Monastery
	Kampong-Tralach, Cambodia	Oxcart ride
9	Kampong-Chhnang, Cambodia	Motor boat excursion to lakeside wetlands
10	Prek Kdam, Cambodia	DISEMBARKATION
	Siem Reap, Cambodia	Motor coach transfer to Siem Reap; Hotel check-in
11	Siem Reap	Angkor Wat, Ta Prohm Temple, Banteay Srei Visit AmaWaterways-sponsored school
12	Siem Reap	Angkor Thom
	Hanoi, Vietnam	Hotel check-in
13	Hanoi	City tour and rickshaw Ride Water Puppet Show
14	Hanoi	Transfer to Ha Long Bay
	Ha Long Bay, Vietnam	Bay excursion Overnight cruise aboard a deluxe Junk
15	Ha Long Bay	Transfer to Hanoi
	Hanoi	Hotel check-in
16	Hanoi	Depart for onward travel

Embark 7-Night Cruise Disembark 7-Night Cruise

Note: Itinerary can be booked as cruise-only.

For full itinerary details, visit www.amawaterways.co.uk

INCLUDED FEATURES

- » 2 nights hotel accommodation in Ho Chi Minh City (Saigon) at the Sofitel Saigon Plaza (or similar), including buffet breakfast
- » 7 nights deluxe cruise accommodation in an outside stateroom, all with twin balconies
- » Immersive excursions and authentic local encounters
- » Fine dining with all meals included during your cruise
- » Unlimited wine with every lunch and dinner on board
- » Complimentary house-brand spirits, local beer and soft drinks during cruise
- » Bottled water in every stateroom replenished daily
- » Welcome Dinner and Farewell Dinner
- » Special highlights on board including folklore dances and music performances, culture discussion forums, theme dinners and music entertainment
- » Non-smoking environment (smoking only permitted in designated areas)
- » 2 nights hotel accommodation in Siem Reap at the Sofitel Angkor Phokeethra Golf & Spa Resort (or similar), including daily buffet breakfast
- » 3 nights hotel accommodation in Hanoi at the Sofitel Legend Metropole (or similar), including daily buffet breakfast
- » Overnight stay on board a luxurious Junk in Ha Long Bay

YOUR ITINERARY

Day 1, ARRIVE IN HO CHI MINH CITY, VIETNAM. Ho Chi Minh City, still affectionately referred to by locals as Saigon, is Vietnam's former capital. Once known as the "Paris of the Orient," it is now an industrial, cultural and educational hub.

Day 2, HO CHI MINH CITY. Always bustling, Ho Chi Minh City is a city of contrasts blending old and new, and east and west. Explore some of the city's most famous landmarks, including the former Presidential Palace, the Central Post Office, Notre Dame Cathedral and the War Remnants Museum. Afterwards, visit the Ben Thanh Market—one of the oldest and most iconic structures in Ho Chi Minh City, where you can search for local handicrafts, colourful textiles, as well as other unique souvenirs. (B,L)

Day 3, HO CHI MINH CITY - EMBARKATION. Board the AmaDara at My Tho Port. Meet your fellow travelers at a Welcome Dinner as the ship cruises to Cai Be. (B,L,D)

Day 4, CAI BE - SA DEC. Take a local boat to Cai Be. You will have an opportunity to visit candy and rice paper making workshops, or alternatively, visit the historic Kiet Old House. Later in the day, journey to Sa Dec, a sprawling town on the Mekong Delta, where French writer Marguerite Duras spent part of her childhood. You will visit the local market, Cao Dai Temple and the house of Mr. Huynh Thuy Le, Duras' Chinese paramour, which her prize-winning novel, "The Lover," is said to be based on. (B,L,D)

Day 5, TAN CHAU - BORDER CROSSING. Enjoy a visit to Tan Chau, a small Mekong River town unspoiled by tourism. You will have the opportunity to take a traditional "xe-loi" (trishaw) ride around the town, with stops at a silk-making, slipper and rattan mat workshops. Alternatively, you can take a boat ride through the narrow channels of the Mekong River to several scenic locations, including a small village known as "Evergreen Island." Return to Tan Chau, where you will visit a rattan mat workshop. Later in the day, cruise from Vietnam to the Cambodian border en route to Phnom Penh. (B,L,D)

Day 6, PHNOM PENH, CAMBODIA. This morning's excursion takes you to Cambodia's infamous Killing Fields and the Khmer Rouge's grim Tuol Sleng S21 detention centre (Genocide Museum) just outside the city. After lunch on board, you'll explore the highlights of the city, followed by a visit to the Royal Palace, the spectacular Silver Pagoda and the National Museum, which has an outstanding collection of Khmer crafts. After returning to the ship, enjoy Khmer folk dancing performed by local children in the Saigon Lounge. (BL,D)

Day 7, PHNOM PENH - KOH CHEN. Experience Phnom Penh via an authentic tuk tuk ride and be enchanted by the city's French colonial architecture and tree-lined boulevards set amidst monumental Angkorian architecture. Alternatively, you may wish to shop for unique treasures at the bustling yellow-coloured Central Market. Later in the morning, set sail for Koh Chen. Once there, take a



ANGKOR WAT, CAMBODIA

CHARMS OF THE MEKONG

walk through Koh Chen and visit home workshops specialising in silver- and copper-smithing to get an up-close view of how local artisans make ornamental items often used in traditional ceremonies. (B,L,D)

Day 8, OUDONG – KAMPONG TRALACH. Situated on a picturesque hillside not far from Phnom Penh, lies Oudong, Cambodia's former royal capital from the early 17th century until 1866. Today, Oudong is a place of pilgrimage for Cambodians. While here, be treated to a memorable Buddhist Blessing Ceremony at a monastery. In Kampong Tralach, you'll have another truly memorable excursion – an oxcart ride through a local village. (B,L,D)

Day 9, KAMPONG CHHNANG – TONLE SAP LAKE. A local motorboat takes you into the lakeside wetlands that form the mouth of Tonle Sap River. Enjoy the stunning variety of bird life here as well as tranquil floating villages. Cap the day off with a Farewell Dinner on board. (B,L,D)

Day 10, PREK KDM – DISEMBARKATION – SIEM REAP. Disembark at Prek Kdam, a small village on the Tonle Sap River, and transfer by coach to Siem Reap, gateway to the Angkor Archaeological Park, a UNESCO World Heritage Site and the former capital of the Khmer empire. During the evening, be treated to a special "Apsara Dancing Show" at your hotel, featuring local Cambodian/Khmer folk dancers. (B,D)

Day 11, SIEM REAP – ANGKOR. Begin your morning exploration of the temple complex at Angkor Wat, the most iconic of all Angkorian temples. Afterwards, visit nearby Ta Prohm, known as the "Kingdom of the Trees," for the way in which the temple stones have become intertwined with thick forest vegetation. You'll also see the fascinating jewel in the crown of Angkorian art, Banteay Srei, which means "Citadel of Women," as it has been said that the carving is too fine to have been done by the hand of man. Later in the day, visit the English-language school sponsored by AmaWaterways in the village of Ta Toum. (B,D)

Note: The English-language school visit is capacity controlled.

Day 12, SIEM REAP – HANOI. After breakfast, you will have a guided sightseeing tour of Angkor Thom meaning "the great city." This is home to Bayon Temple, best known for its gigantic smiling stone faces, as well as the Terrace of the Elephants and the Terrace of the Leper King. Later in the day, take a short flight to Hanoi, the capital city of Vietnam. (B,L)

Day 13, HANOI. From ancient temples to French colonial architecture and modern-day skyscrapers, along with beautiful parks and lakes, Hanoi is an eclectic and lively city. A morning sightseeing tour will showcase some of Hanoi's most famous historic and cultural sites, including Ba Dinh Square, One Pillar Pagoda and The Temple of Literature. You will also visit the infamous prison that American POWs sarcastically dubbed the "Hanoi Hilton" during the Vietnam War. In the afternoon, experience an authentic rickshaw ride (known as a "cyclo") in the Old Quarter, followed by a traditional Water Puppet Show. (B)

Day 14, HANOI – HA LONG BAY. Take a scenic drive from Hanoi to one of Vietnam's most renowned locations, Ha Long Bay, a UNESCO World Heritage Site. Board a deluxe Junk, which combines classic beauty with modern conveniences for an incredible once-in-a-lifetime experience and an AmaWaterways exclusive. The backdrop of the bay's magnificent scenery and dramatic limestone cliffs and rock formations provide you with the perfect setting for a memorable dinner. (B,L,D)

Day 15, HA LONG BAY – HANOI. Spend the morning sailing across the emerald waters of Ha Long Bay with more than 2,000 small islands rising from the water like a dragon's back. Later in the morning, disembark the Junk and transfer back to Hanoi where you can enjoy the remainder of the day at leisure. (B,L)

Day 16, DEPART HANOI. Bid farewell to Vietnam and prepare for your homeward flight. (B)

OTHER ITINERARY OPTIONS – 12 NIGHTS

For those who wish to discover the wonders of the Mekong in less time, we also offer shorter itinerary options. Fly to Ho Chi Minh City, named after the first leader of North Vietnam, to spend 2 nights in the city before boarding the AmaDara. In Ho Chi Minh City you will explore all facets of this industrial, cultural and educational hub, once known as "the Paris of the Orient". After check out of your hotel, transfer to your ship for the northward 7 night cruise. Upon disembarkation, transfer to Siem Reap for 3 nights. Here you will discover the incredible temples and history of one of the world's most iconic sites with a range of excursions.

For full details on this itinerary visit www.amawaterways.co.uk

DATES AND FARES (£)

HOTEL CHECK IN*	START CITY	SHIP NAME	12-NIGHT CRUISE & LAND	15-NIGHT CRUISE & LAND
2018				
Jan 06	Ho Chi Minh City	AmaDara	£2,972	£3,639
Jan 20	Ho Chi Minh City	AmaDara	£2,972	£3,639
Feb 03	Ho Chi Minh City	AmaDara	£2,972	£3,639
Feb 17	Ho Chi Minh City	AmaDara	£2,972	£3,639
Mar 03	Ho Chi Minh City	AmaDara	£2,972	£3,639
Mar 17	Ho Chi Minh City	AmaDara	£2,839	£3,506
Mar 31	Ho Chi Minh City	AmaDara	£2,706	£3,373
Apr 14	Ho Chi Minh City	AmaDara	£2,572	£3,239
Aug 04	Ho Chi Minh City	AmaDara	£2,439	£3,106
Aug 18	Ho Chi Minh City	AmaDara	£2,439	£3,106
Sep 01	Ho Chi Minh City	AmaDara	£2,572	£3,239
Sep 15	Ho Chi Minh City	AmaDara	£2,706	£3,373
Sep 29	Ho Chi Minh City	AmaDara	£2,839	£3,506
Oct 13	Ho Chi Minh City	AmaDara	£2,906	£3,573
Oct 27	Ho Chi Minh City	AmaDara	£2,906	£3,573
Nov 10	Ho Chi Minh City	AmaDara	£2,906	£3,573
Nov 24	Ho Chi Minh City	AmaDara	£2,906	£3,573
Dec 08	Ho Chi Minh City	AmaDara	£2,906	£3,573
Dec 22	Ho Chi Minh City	AmaDara	£2,906	£3,573
2019				
Jan 05	Ho Chi Minh City	AmaDara	£2,972	£3,639
Jan 19	Ho Chi Minh City	AmaDara	£2,972	£3,639
Feb 02	Ho Chi Minh City	AmaDara	£2,972	£3,639
Feb 16	Ho Chi Minh City	AmaDara	£2,972	£3,639
Mar 02	Ho Chi Minh City	AmaDara	£2,972	£3,639
Mar 16	Ho Chi Minh City	AmaDara	£2,839	£3,506
Mar 30	Ho Chi Minh City	AmaDara	£2,706	£3,373
Apr 13	Ho Chi Minh City	AmaDara	£2,572	£3,239

*Hotel Check In date is based on 15 Night package, please call for alternative start dates.

Flights: Please call for fares and availability.

Transfers: Hanoi Hotel to Hanoi Airport: from £20 per person.

Siem Reap Hotel to Siem Reap Airport: from £20 per person.

Saigon Airport to Ho Chi Minh City Hotel: from £20 per person.

Cruise fares are per person based on double occupancy in a Cat. C, deluxe outside stateroom with window.

To upgrade to a higher category, add per person:

CAT.	DECK	STATEROOM	ADD'L
B	Sadec, Saigon & Tonle	French & Outside Balcony	£399
A	Saigon	French & Outside Balcony	£599
Suite (S)	Sadec	French & Outside Balcony	£933
Luxury Suite (L)	Sadec	French & Outside Balcony	£1,799

Port Charges: Fares include port charges of £107 per person

Single Supplement: Categories C-A add: 50% per person;

Suite: add 75% per person; Luxury Suite: add 100% per person.

Intra-Asia Air (Siem Reap-Hanoi):

£240 per person including taxes and fuel surcharges is included in the 15 Night Cruise Fare

Bedding: Please call for details

Deck Plans: AMADARA - See page 172.

Single Supplement Pre- and Post-Cruise Land Arrangements:

15 Nights £733 per person 12 Nights £399 per person

Visa: For visa information, please refer to page 176

Please note that the docking process may involve narrow walkways, local tender boats or dirt-covered paths.

THE CHOBE RIVER



AFRICA SAFARIS & WILDLIFE CRUISE

4-NIGHT SAFARI CRUISE AND 2 NIGHTS IN VICTORIA FALLS, PLUS 5 DIFFERENT LAND PROGRAMMES FROM WHICH TO CHOOSE



After spending a lifetime cruising the world's greatest waterways, AmaWaterways President Rudi Schreiner ventured along southern Africa's Chobe River for the first time in 2011. Utterly amazed by the multitude of birds and animals easily observed along the banks of the river, he realised the Chobe offered a truly exceptional river experience—up-close, unhurried and unsurpassed wildlife-viewing. Now this same life-changing experience is available to AmaWaterways guests. Choose one of five unique land-and-cruise itineraries in Africa, all of which feature a four-night Chobe River safari cruise on board the Zambezi Queen and two nights at the legendary Victoria Falls.

YOUR SAFARI OPTIONS:

DISCOVER AFRICA - PAGE 154

3 nights in Cape Town | 4 nights on the Chobe River | 2 nights in Victoria Falls with optional 2-night Johannesburg/Soweto extension

RIVERS & RAILS OF AFRICA - PAGE 156

3 nights in Cape Town | 4 nights on the Chobe River | 2 nights in Victoria Falls | 3-night Rovos Rail train journey

WILDLIFE & THE FALLS - PAGE 158 **NEW FOR 2018**

1 night in Johannesburg | 4 nights on the Chobe River | 2 nights in Victoria Falls | 2 nights in Johannesburg | 3 nights at a safari lodge in the Kruger National Park

STARS OF SOUTH AFRICA - PAGE 160

3 nights in Cape Town | 4 nights on the Chobe River | 2 nights in Victoria Falls | 2 nights in Johannesburg | 3 nights at a safari lodge in the Kruger National Park Area

GOLDEN TRAILS OF EAST AFRICA - PAGE 162

1 night in Johannesburg (OR 3-night Cape Town pre-extension) | 4 nights on the Zambezi Queen | 2 nights in Victoria Falls | 2 nights in Johannesburg | 7-night East Africa safari in Tanzania (Arusha, Tarangire, Ngorongoro & Serengeti)

CRUISE & VICTORIA FALLS DETAILS

MONDAY, ZAMBEZI QUEEN - EMBARKATION. On arrival in Kasane from Cape Town or Johannesburg transfer to the Chobe River, where a private safari boat will transport you to the Zambezi Queen. Late this afternoon, enjoy a sunset cruise down the Chobe River before a Welcome Cocktail and Dinner on board the ship. (B,D)

TUESDAY, ZAMBEZI QUEEN. This morning embark on a boat safari to explore the Chobe River's spectacular game viewing. Then journey back to the Zambezi Queen for lunch as well as time to relax on board. Later today, enjoy a slightly different version of a river safari aboard a special double decker barge which will allow you to venture into the southern channels. This excursion will offer you an unusual viewpoint to observe hippos and elephants in their natural habitat. (B,L,D)

WEDNESDAY, ZAMBEZI QUEEN. Join a full-day safari of Chobe National Park in open-top 4x4 vehicles. Chobe National Park is home to one of the most dense populations of wildlife in Africa. Be on the lookout for elephants, giraffe, zebra, sable, warthog and cape buffalo. Prides of lions, hyenas and (more rarely) cheetahs, are normally visible along the way. Lunch will be a delicious picnic served under the trees. (B,L,D)

THURSDAY, ZAMBEZI QUEEN. This morning, enjoy an unforgettable visit to a typical African village to experience the local culture firsthand. Spend time with the children of the village as well as its elders and learn about their day-to-day life. After lunch on board, you can choose your afternoon activity, including an afternoon safari by boat, bird watching or fishing. Tonight, your crew hosts an African-themed dinner complete with singing and dancing. (B,L,D)

FRIDAY, ZAMBEZI QUEEN - DISEMBARKATION - VICTORIA FALLS. Transfer to legendary Victoria Falls, one of the greatest natural wonders on earth. Spend the afternoon exploring the town or experience one of the many optional activities. Tonight, join a scenic vintage steam train ride over the Victoria Falls Bridge complete with cocktails and appetizers. Dinner follows at the hotel. (B,D)

SATURDAY, VICTORIA FALLS. A local guide will take you on a tour of remarkable Victoria Falls. You'll learn about its history and the flora and fauna that make this area so unique. Tonight, embark on a private and festive sunset cruise along the Zambezi River. Relax on board as you observe a variety of game while enjoying a delicious mix of tapas with drinks. (B)

SUNDAY, ONWARD JOURNEY. Bid adieu to Victoria Falls as you choose from four extension options including, Johannesburg, Kruger National Park, a Rovos Rail luxury journey or the Serengeti in Tanzania. (B)

INCLUDED FEATURES

CAPE TOWN

- » Arrival airport transfer
- » 3 nights at the luxurious Cape Grace Hotel in upgraded Table Mountain view rooms including daily breakfast
- » Welcome Reception with drinks and tapas
- » Full-day Cape of Good Hope tour, including African Penguin encounter and local lunch with drinks
- » Cableway to the summit of Table Mountain
- » Cape Winelands tour, including tastings and lunch OR guided visit to Robben Island, followed by lunch and tour of Cape Town's diverse neighbourhoods

ZAMBEZI QUEEN SAFARI CRUISE

- » 4 nights accommodation in balcony stateroom
- » Chobe National Park game safari
- » Exclusive private picnic in Chobe National Park
- » Private boat safaris along the Chobe riverbank
- » Visit to an African village for a cultural interaction with the community
- » African-themed dinner
- » All meals included during the cruise with complimentary wine, beer and spirits

VICTORIA FALLS

- » 2-night stay at the Victoria Falls Hotel in upgraded Stable Wing rooms, including daily breakfast
- » Sunset cocktail reception aboard a historic steam train to Victoria Falls Bridge, followed by dinner
- » Guided tour of Victoria Falls National Park
- » Exclusive Zambezi River sunset cruise with drinks and tapas

DISCOVER AFRICA

9 OR 11 NIGHTS · TRAVEL TO CAPE TOWN AND RETURN FROM JOHANNESBURG

3 NIGHTS IN CAPE TOWN FOLLOWED BY A 4-NIGHT SAFARI CRUISE AND 2 NIGHTS IN VICTORIA FALLS WITH OPTION TO EXTEND FOR 2 NIGHTS IN JOHANNESBURG



Discover Africa by starting with three nights in cosmopolitan Cape Town bordered by the iconic Table Mountain. While here, visit the Cape of Good Hope, the most-southwestern point of the African continent, and Boulders Beach, home to thousands of African penguins. Next, fly to Kasane where you will transfer to the Chobe River to begin your four-night wildlife cruise aboard the Zambezi Queen. Explore Chobe National Park, home to one of the densest populations of wildlife on the African continent. Encounter elephants, giraffes, leopards, lions, gazelles, zebras and buffalos on excursions by boat or open-air vehicle. Conclude your journey with two nights at legendary Victoria Falls, one of the world's most spectacular natural wonders. You have the option of extending your adventure in Johannesburg and reliving the period of Nelson Mandela and the end of the Apartheid era.



GRACIOUS HOSPITALITY THROUGHOUT YOUR JOURNEY



OBSERVE WILDLIFE IN THEIR NATIVE HABITAT

DAILY PROGRAMME FEATURES

DAY	DESTINATION	ACTIVITIES
1	Cape Town, South Africa	Hotel check-in Welcome Reception
2	Cape Town	Full-day Cape of Good Hope tour Lunch in local restaurant with drinks
3	Cape Town	Cableway up Table Mountain Scenic drive through Cape Winelands with tastings and lunch OR Robben Island guided tour with lunch in local restaurant
4	Cape Town Zambezi Queen	Morning flight to Kasane, Botswana EMBARKATION Welcome Cocktail and Dinner
5	Zambezi Queen	Chobe River safaris by boat
6	Zambezi Queen	Full-day safari of Chobe National Park by open top 4x4 vehicle with picnic lunch
7	Zambezi Queen	Morning visit to local African village Afternoon safari by boat OR Birdwatching OR Fishing African-themed dinner
8	Zambezi Queen	DISEMBARKATION Transfer to Victoria Falls Sunset cocktail reception aboard a vintage steam train, followed by dinner
9	Victoria Falls	Guided tour of Victoria Falls Free afternoon Zambezi River sunset cruise with tapas
10	Victoria Falls	Flight to Johannesburg Return flight home or extend in Johannesburg

✳ Embark 4-Night Safari Cruise

⚓ Disembark 4-Night Safari Cruise

HOTEL ACCOMMODATIONS

Your itinerary includes stays at two idyllic venues, Cape Grace Hotel and The Victoria Falls Hotel, both members of the ultra-exclusive Leading Hotels of the World® collection.

CAPE GRACE HOTEL



Ideally located on a private quay on the Victoria & Alfred Waterfront, the 120-room Cape Grace effortlessly melds the modern comforts of a Cape Town luxury hotel with traditional Cape culture. The hotel offers gracious service and your upgraded Table Mountain luxury view room features French doors and step-out balconies. The property also boasts a whisky, wine and cocktail bar; a world-class spa; and a library, where guests can enjoy sherry and port every evening.

THE VICTORIA FALLS HOTEL



This elegant landmark hotel has been a highly desirable destination for more than a century, with its Edwardian-style décor, broad verandas and tropical gardens with lily ponds and palm trees. The hotel of choice for royalty, statesmen and international celebrities, the tranquil and secluded 'Grand ol' Lady of the Falls' is a mere ten minute walk from the legendary Victoria Falls, so you can easily visit it multiple times during your stay. Your two night stay will be in upgraded Stable Wing rooms.

DATES AND FARES (£)

HOTEL CHECK-IN DATE	EMBARK DATE	SHIP NAME	9-NIGHT CRUISE & LAND
2018			
Mar 30	Apr 02	Zambezi Queen	£6,996
Apr 20	Apr 23	Zambezi Queen	£7,062
May 04	May 07	Zambezi Queen	£7,062
May 18	May 21	Zambezi Queen	£7,062
Jun 01	Jun 04	Zambezi Queen	£7,062
Jun 15	Jun 18	Zambezi Queen	£7,062
Jul 06	Jul 09	Zambezi Queen	£7,062
Jul 20	Jul 23	Zambezi Queen	£7,062
Aug 03	Aug 06	Zambezi Queen	£7,062
Aug 17	Aug 20	Zambezi Queen	£7,062
Aug 31	Sep 03	Zambezi Queen	£7,062
Sep 14	Sep 17	Zambezi Queen	£7,062
Sep 28	Oct 01	Zambezi Queen	£7,062
Oct 12	Oct 15	Zambezi Queen	£7,062
Nov 02	Nov 05	Zambezi Queen	£6,996
Nov 16	Nov 19	Zambezi Queen	£6,996
2019			
Mar 12	Mar 15	Zambezi Queen	£6,929

Flights: Please call for fares and availability.

All prices are per person, based on double occupancy in stateroom Cat. SB.

To upgrade to a higher category, add per person:

CAT.	DECK LEVEL	STATEROOM	ADD'L
SA	Lower/Middle	Balcony	£166
MS	Lower/Middle	Balcony	£566

Single Supplement: Categories SB-SA: add 40% per person; Category MS: add 100% per person.

Intra-Africa Air: £1,063 per person, including taxes and fuel surcharges, is included in the fare.

Deck Plans: ZAMBEZI QUEEN - See page 174.

Visas: For visa information, please refer to page 176

2-NIGHT JOHANNESBURG & SOWETO POST-CRUISE EXTENSION

An optional 2-night Johannesburg extension is available for **£850** per person.

This package includes accommodation at the 5-star Fairlawns Boutique Hotel in a Château suite, evening presentation by a local expert, followed by dinner, a full-day tour to Soweto including lunch and round-trip airport transfers.

INCLUDED FEATURES

CAPE TOWN

- » Arrival airport transfer
- » 3 nights at the luxurious Cape Grace Hotel in upgraded Table Mountain view rooms, including daily breakfast
- » Welcome Reception with drinks and tapas
- » Full-day Cape of Good Hope tour, including African Penguin encounter and local lunch with drinks
- » Cableway to the summit of Table Mountain
- » Cape Winelands tour, including tastings and lunch OR guided visit to Robben Island, followed by lunch and tour of Cape Town's diverse neighbourhoods

ZAMBEZI QUEEN SAFARI CRUISE

- » 4-night accommodations in a balcony suite
- » Chobe National Park safari
- » Private boat safaris along the banks of the Chobe River
- » Visit to African village for a cultural interaction with the community
- » African-themed dinner
- » All meals included during the cruise with complimentary wine, beer and spirits

VICTORIA FALLS

- » Upgraded Stable Wing rooms, including daily breakfast
- » Sunset cocktail reception aboard a historic steam train to Victoria Falls Bridge, followed by dinner
- » Guided tour of Victoria Falls National Park
- » Exclusive Zambezi River sunset cruise with drinks and tapas
- » Victoria Falls neighborhood tour with home hosted lunch

ROVOS RAIL

- » 3-night journey on the Rovos Rail luxury train in an upgraded deluxe suite
- » All meals and drinks included on board the train
- » Excursions accompanied by a qualified guide
- » 24-hour full room service and bar facilities

JOHANNESBURG

- » Departure airport transfer

RIVERS & RAILS OF AFRICA

12 NIGHTS · TRAVEL TO CAPE TOWN AND RETURN FROM JOHANNESBURG

3 NIGHTS IN CAPE TOWN FOLLOWED BY A 4-NIGHT SAFARI CRUISE AND 2 NIGHTS IN VICTORIA FALLS, THEN 3 NIGHTS ABOARD THE ROVOS RAIL LUXURY TRAIN



Begin your African adventure with a three-night stay in Cape Town where you'll explore the Atlantic Seaboard, including the Cape of Good Hope; you'll also be treated to an African penguin encounter. Enjoy panoramic views of Cape Town while riding a cableway up to Table Mountain, and then choose between a Cape Winelands tour with visits to two of its most renowned wineries, or visit Robben Island, which includes a cultural tour of Cape Town's diverse neighbourhoods. From Cape Town, fly to Kasane, Botswana for your four-night Zambezi Queen safari cruise on the Chobe River. Explore Chobe National Park, home to one of the densest populations of wildlife on the African continent. Continue your journey with two nights at the legendary Victoria Falls, one of the world's great and impressive natural wonders. From here, you will join the Rovos Rail—considered the most luxurious train journey in the world—for three nights. Recapture the romance and atmosphere of a bygone era as you travel for approximately 1,000 miles from Zimbabwe into South Africa.



ROVOS RAIL TRAIN



ROVOS RAIL OBSERVATION LOUNGE

DAILY PROGRAMME FEATURES

DAY	DESTINATION	ACTIVITIES
1	Cape Town, South Africa	Hotel check-in Welcome Reception
2	Cape Town	Full-day Cape of Good Hope tour Lunch in local restaurant with drinks
3	Cape Town	Cableway up Table Mountain Scenic drive through Cape Winelands with tastings and lunch OR Robben Island guided tour with lunch in local restaurant
4	Cape Town Zambezi Queen	Morning flight to Kasane, Botswana EMBARKATION Welcome Cocktail and Dinner
5	Zambezi Queen	Chobe River safaris by boat
6	Zambezi Queen	Full-day safari of Chobe National Park by open top 4x4 vehicle with picnic lunch
7	Zambezi Queen	Morning visit to local African village Afternoon safari by boat OR Birdwatching OR Fishing African-themed dinner
8	Zambezi Queen Victoria Falls, Zimbabwe	DISEMBARKATION Transfer to Victoria Falls Sunset cocktail reception aboard a vintage steam train, followed by dinner
9	Victoria Falls	Guided tour of Victoria Falls Free afternoon Zambezi River sunset cruise with tapas
10	Victoria Falls Rovos Rail	Embark the Rovos Rail luxury train in the afternoon Dinner served en route to Kennedy Siding
11	Rovos Rail	Morning Hwange Game Reserve safari Continue south
12	Rovos Rail	Cross into South Africa, passing through villages and towns as well as sweeping landscapes
13	Rovos Rail Johannesburg, South Africa	Arrive in Pretoria mid-morning Transfer to Johannesburg Airport Return flight home

✪ Embark 4-Night Safari Cruise

⬆ Disembark 4-Night Safari Cruise

ROVOS RAIL

One of the highlights of this itinerary is the utterly luxurious Rovos Rail vintage train, the Pride of Africa. This amazing train will transport you in gracious Edwardian-style through the heart of the African bush and past some of the continent's most incredible scenery.

DELUXE SUITES



Your upgraded richly panelled, air-conditioned, 118-square foot deluxe suite offers comfortable twin or double beds, a lounge area, en-suite bathroom with shower, a personal safe, a bar fridge filled with beverages of your choice and 24-hour room service.

EXQUISITE CUISINE



The Victorian dining room offers fine china, crisp linen, silverware and delicious five-star cuisine paired with excellent South African wines. Dressing up for dinner is entirely appropriate here, with jackets and ties for men and cocktail attire for women.

DATES AND FARES (£)

HOTEL CHECK-IN DATE	EMBARK DATE	SHIP NAME	12-NIGHT CRUISE & LAND
Mar 09	Mar 12	Zambezi Queen	£9,713
Apr 20	Apr 23	Zambezi Queen	£9,847
May 04	May 07	Zambezi Queen	£9,980
May 18	May 21	Zambezi Queen	£9,980
Jun 01	Jun 04	Zambezi Queen	£9,980
Jun 15	Jun 18	Zambezi Queen	£9,980
Jul 06	Jul 09	Zambezi Queen	£9,980
Jul 20	Jul 23	Zambezi Queen	£9,980
Aug 03	Aug 06	Zambezi Queen	£9,980
Aug 17	Aug 20	Zambezi Queen	£9,980
Aug 31	Sep 03	Zambezi Queen	£9,980
Sep 14	Sep 17	Zambezi Queen	£9,980
Sep 28	Oct 01	Zambezi Queen	£9,980
Oct 12	Oct 15	Zambezi Queen	£9,913
Nov 02	Nov 05	Zambezi Queen	£9,780
Nov 16	Nov 19	Zambezi Queen	£9,780

Flights: Please call for fares and availability.

All fares are per person, based on double occupancy in stateroom Cat. SB.

To upgrade to a higher category, add per person:

CAT.	DECK LEVEL	STATEROOM	ADD'L
SA	Lower/Middle	Balcony	£166
MS	Lower/Middle	Balcony	£566

Single Supplement: Categories SB-SA: add 40% per person; Category MS: add 100% per person.

Intra-Africa Air: £650 per person, including taxes and fuel surcharges, is included in the fare.

Deck Plans: ZAMBEZI QUEEN - See page 174.

Visas: For visa information, please refer to page 176



SAVOUR THE SIGHTS OF AN AFRICAN SAFARI

INCLUDED FEATURES

JOHANNESBURG

- » Arrival airport transfer
- » 1 night at the luxurious Fairlawns Boutique Hotel, in a Grand Château suite, including breakfast

ZAMBEZI QUEEN SAFARI CRUISE

- » 4-night accommodations in balcony suite
- » Chobe National Park safari
- » Boat safaris along the banks of the Chobe River
- » Visit an African village
- » African-themed dinner
- » All meals included during the cruise with complimentary wine, beer and spirits

VICTORIA FALLS

- » 2-night stay at the Victoria Falls Hotel in upgraded Stable Wing rooms, including daily breakfast
- » Sunset cocktail reception aboard a historic steam train to Victoria Falls Bridge, followed by dinner
- » Guided tour of Victoria Falls National Park
- » Exclusive Zambezi River sunset cruise with drinks and tapas

JOHANNESBURG

- » 2 nights at the Fairlawns Boutique Hotel in a Grand Château suite including breakfast daily
- » Evening presentation by a local expert, followed by a special multi-course dinner, including South African wines
- » Soweto tour, including Nelson Mandela landmarks, Apartheid Museum and lunch

KRUGER NATIONAL PARK

- » 3 nights in a suite at Tintswalo Safari Lodge or Makanyi Game Lodge
- » Daily morning, afternoon and evening game drives
- » No more than 6 guests per safari vehicle on all game drives
- » All meals, drinks and laundry included at the lodge

WILDLIFE & THE FALLS

12 NIGHTS · TRAVEL TO JOHANNESBURG AND RETURN FROM JOHANNESBURG

1 NIGHT IN JOHANNESBURG FOLLOWED BY A 4-NIGHT SAFARI CRUISE, 2 NIGHTS IN VICTORIA FALLS, 2 NIGHTS IN JOHANNESBURG & 3 NIGHTS AT A SAFARI LODGE IN GREATER KRUGER NATIONAL PARK



Spend one night in South Africa's largest city, Johannesburg, before flying to Kasane, Botswana to begin your Zambezi Queen safari cruise on the Chobe River. After exploring the Chobe region and National Park, spend two nights experiencing the magic of Victoria Falls, one of the seven natural wonders of the world. Fly back to Johannesburg for two nights, and while here, visit the township of Soweto and walk in the footsteps of Nelson Mandela, learning about the region's past struggles and the rise of the human spirit. Then take a short flight to the game-rich country of the Greater Kruger National Park—home to the Big 5: lions, leopards, rhinos, elephants and buffalo. The world-renowned Greater Kruger National Park covers an area of 50-million acres in which animals roam freely. Spend three nights at a five-star game lodge, known for some of the best safari viewing in Africa, as well exceptional amenities, service and cuisine.



SAFARI IN KRUGER NATIONAL PARK AREA



EXPERIENCE THE WONDER OF VICTORIA FALLS

DAILY PROGRAMME FEATURES

DAY	DESTINATION	ACTIVITIES
1	Johannesburg, South Africa	Arrival transfer and hotel check-in
2	Johannesburg	Late night flight to Kasane, Botswana
	Zambezi Queen	EMBARKATION Welcome Cocktail and Dinner
3	Zambezi Queen	Chobe River safaris by boat
4	Zambezi Queen	Full-day safari of Chobe National Park by open top 4x4 vehicle with picnic lunch
5	Zambezi Queen	Morning visit to local African village Afternoon safari by boat OR Birdwatching OR Fishing African-themed dinner
6	Zambezi Queen	DISEMBARKATION
	Victoria Falls, Zimbabwe	Transfer to Victoria Falls Sunset cocktail reception aboard a vintage steam train, followed by dinner
7	Victoria Falls	Guided tour of Victoria Falls Free afternoon Zambezi River sunset cruise with tapas
8	Johannesburg, South Africa	Flight to Johannesburg Special dinner and presentation
9	Johannesburg	Soweto tour with lunch
10	Kruger Park Area, South Africa	Flight to Hoedspruit (Greater Kruger Park) Lunch at lodge and afternoon safari
11	Kruger Park Area	Morning and afternoon safaris
12	Kruger Park Area	Morning and afternoon safaris
13	Kruger Park Area	Early morning safari Flight to Johannesburg
	Johannesburg	Return flight home

⚓ Embark 4-Night Safari Cruise

⚓ Disembark 4-Night Safari Cruise

YOUR LODGE ACCOMMODATIONS

Choose your luxurious lodge accommodations in the Greater Kruger National Park area

TINTSWALO SAFARI LODGE



Set amidst ancient sycamore trees and nestled along a seasonal river, this luxurious lodge boasts six classic suites (725 sq. ft.), each with a plunge pool. Morning and afternoon safaris are available each day. All meals, beverages, laundry and Wi-Fi are included.

MAKANYI SAFARI LODGE



This recently opened exclusive lodge has only seven extra-large suites (1,500 sq. ft.). Your stay includes all meals, beverages, laundry service, Wi-Fi, use of the gym and inviting pool, as well as daily morning and afternoon safaris.

DATES AND FARES (£)

HOTEL CHECK-IN DATE	EMBARK DATE	SHIP NAME	12-NIGHT CRUISE & LAND
Mar 11	Mar 12	Zambezi Queen	£9,527
Apr 01	Apr 02	Zambezi Queen	£9,727
Apr 22	Apr 23	Zambezi Queen	£9,860
May 06	May 07	Zambezi Queen	£9,994
May 20	May 21	Zambezi Queen	£9,994
Jun 03	Jun 04	Zambezi Queen	£9,994
Jun 17	Jun 18	Zambezi Queen	£9,994
Jul 08	Jul 09	Zambezi Queen	£9,994
Jul 22	Jul 23	Zambezi Queen	£9,994
May 08	Aug 06	Zambezi Queen	£9,994
Aug 19	Aug 20	Zambezi Queen	£9,994
Sep 02	Sep 03	Zambezi Queen	£9,994
Sep 16	Sep 17	Zambezi Queen	£9,994
Sep 30	Oct 01	Zambezi Queen	£9,994
Oct 14	Oct 15	Zambezi Queen	£9,927
Nov 04	Nov 05	Zambezi Queen	£9,727
Nov 18	Nov 19	Zambezi Queen	£9,527

Flights: Please call for fares and availability.

All fares are per person, based on double occupancy in stateroom Cat. SB.

To upgrade to a higher category, add per person:

CAT.	DECK LEVEL	STATEROOM	ADD'L
SA	Lower/Middle	Balcony	£166
MS	Lower/Middle	Balcony	£566

Single Supplement: Categories SB-SA: add 40% per person; Category MS: add 100% per person.

Intra-Africa Air: £1,197 per person, including taxes and fuel surcharges, is included in the fare.

Deck Plans: ZAMBEZI QUEEN - See page 174.

Visas: For visa information, please refer to page 176



INCLUDED FEATURES

CAPE TOWN

- » Arrival airport transfer
- » 3 nights at the luxurious Cape Grace Hotel in upgraded Table Mountain View rooms including daily breakfast
- » Welcome Reception with drinks and tapas
- » Full-day Cape of Good Hope tour, including African Penguin encounter and local lunch with drinks
- » Cableway to the summit of Table Mountain
- » Cape Winelands tour, including tastings and lunch OR guided visit to Robben Island, followed by lunch and tour of Cape Town's diverse neighbourhoods

ZAMBEZI QUEEN SAFARI CRUISE

- » 4-night accommodations in balcony suite
- » Chobe National Park safari
- » Boat safaris along the banks of the Chobe River
- » Visit an African village
- » African-themed dinner
- » All meals included during the cruise with complimentary wine, beer and spirits

VICTORIA FALLS

- » 2-night stay at the Victoria Falls Hotel in upgraded Stable Wing rooms, including daily breakfast
- » Sunset cocktail reception aboard a historic steam train to Victoria Falls Bridge, followed by dinner
- » Guided tour of Victoria Falls National Park
- » Exclusive Zambezi River sunset cruise

JOHANNESBURG

- » 2 nights at the Fairlawns Boutique Hotel in a Grand Château suite, including breakfast daily
- » Evening presentation by a local expert, followed by a special multi-course dinner, including South African wines
- » Johannesburg and Soweto tour with lunch

KRUGER NATIONAL PARK

- » 3 nights in a suite at Tintswalo Safari Lodge or Makanyi Game Lodge
- » Daily morning, afternoon and evening game drives
- » No more than 6 guests per safari vehicle on all game drives
- » All meals, drinks and laundry included at the lodge

STARS OF SOUTH AFRICA

14 NIGHTS · TRAVEL TO CAPE TOWN AND RETURN FROM JOHANNESBURG

3 NIGHTS IN CAPE TOWN FOLLOWED BY A 4-NIGHT SAFARI CRUISE AND 2 NIGHTS IN VICTORIA FALLS, 2 NIGHTS IN JOHANNESBURG AND 3 NIGHTS AT A SAFARI LODGE IN GREATER KRUGER NATIONAL PARK

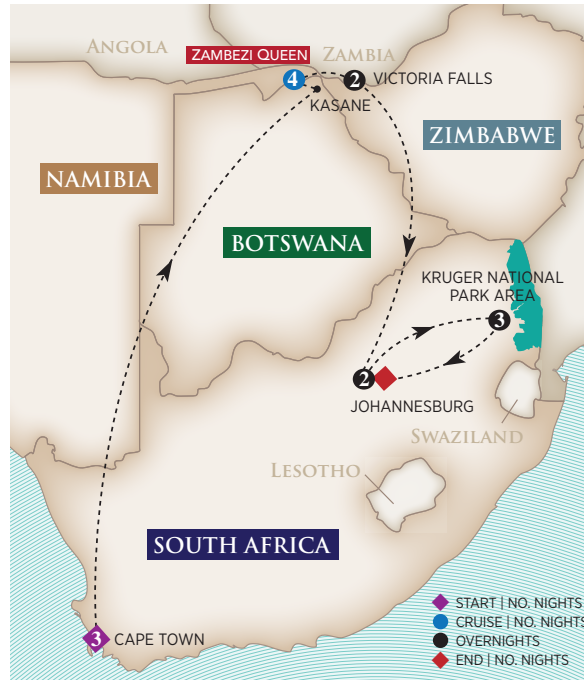

Begin your Stars of South Africa journey with a three-night stay in Cape Town, known for its beautiful beaches, iconic mountain and inviting waterfront. Next, fly to Kasane, Botswana to begin your Zambezi Queen safari cruise on the Chobe River. You'll also explore Chobe National Park, home to one of the densest populations of wildlife on the African continent as well as the largest population of elephants in Africa. From here, spend two nights at one of the most spectacular waterfalls in the world, Victoria Falls, before flying to Johannesburg for two nights, which includes a visit to the township of Soweto. Continue your adventure by flying to Hoedspruit, located in the game-rich country of Greater Kruger National Park. Spend three nights at a luxurious game lodge in this premier eco-tourist destination, known for some of the best "Big Five" viewing in Africa.



LEOPARDS ARE ONE OF THE "FIVE" BIG CATS



SAFARI AT TINTSWALO

DAILY PROGRAMME FEATURES

DAY	DESTINATION	ACTIVITIES
1	Cape Town, South Africa	Hotel check-in Welcome Reception
2	Cape Town	Full-day Cape of Good Hope tour Lunch in local restaurant with drinks
3	Cape Town	Cableway up Table Mountain Scenic drive through Cape Winelands with tastings and lunch OR Robben Island guided tour with lunch in local restaurant
4	Cape Town Zambezi Queen	Morning flight to Kasane, Botswana EMBARKATION Welcome Cocktail and Dinner
5	Zambezi Queen	Chobe River safaris by boat
6	Zambezi Queen	Full-day safari of Chobe National Park by open top 4x4 vehicle with picnic lunch
7	Zambezi Queen	Morning visit to local African village Afternoon safari by boat OR Birdwatching OR Fishing African-themed dinner
8	Zambezi Queen	DISSEMBARKATION Transfer to Victoria Falls Sunset cocktail reception aboard a vintage steam train, followed by dinner
	Victoria Falls, Zimbabwe	
9	Victoria Falls	Guided tour of Victoria Falls Free afternoon Zambezi River sunset cruise with tapas
10	Johannesburg, South Africa	Flight to Johannesburg Special dinner and presentation
11	Johannesburg	Soweto tour with lunch
12	Kruger Park, South Africa	Flight to Hoedspruit (Greater Kruger Park) Lunch at lodge Afternoon safari
13	Kruger Park	Morning and afternoon safaris
14	Kruger Park	Morning and afternoon safaris
15	Kruger Park	Early morning safari Flight to Johannesburg
	Johannesburg	Return flight home

⚓ Embark 4-Night Safari Cruise

⚓ Disembark 4-Night Safari Cruise

YOUR LODGE ACCOMMODATIONS

Choose your luxurious lodge accommodations in the Greater Kruger National Park area

TINTSWALO SAFARI LODGE



Set amidst ancient sycamore trees and nestled along a seasonal river, this luxurious lodge boasts six classic suites (725 sq. ft.), each with a plunge pool. Morning and afternoon safaris are available each day. All meals, beverages, laundry and Wi-Fi are included.

MAKANYI SAFARI LODGE



This recently opened exclusive lodge has only seven extra-large suites (1,500 sq. ft.). Your stay includes all meals, beverages, laundry service, Wi-Fi, use of the gym and inviting pool, as well as daily morning and afternoon safaris.

DATES AND FARES (£)

HOTEL CHECK-IN DATE	EMBARK DATE	SHIP NAME	16-NIGHT CRUISE & LAND
Mar 09	Mar 12	Zambezi Queen	£10,280
Mar 30	Apr 02	Zambezi Queen	£10,480
Apr 20	Apr 23	Zambezi Queen	£10,614
May 04	May 07	Zambezi Queen	£10,747
May 18	May 21	Zambezi Queen	£10,747
Jun 01	Jun 04	Zambezi Queen	£10,747
Jun 15	Jun 18	Zambezi Queen	£10,747
Jul 06	Jul 09	Zambezi Queen	£10,747
Jul 20	Jul 23	Zambezi Queen	£10,747
Aug 03	Aug 06	Zambezi Queen	£10,747
Aug 17	Aug 20	Zambezi Queen	£10,747
Aug 31	Sep 03	Zambezi Queen	£10,747
Sep 14	Sep 17	Zambezi Queen	£10,747
Sep 28	Oct 01	Zambezi Queen	£10,614
Oct 12	Oct 15	Zambezi Queen	£10,680
Nov 02	Nov 05	Zambezi Queen	£10,480
Nov 16	Nov 19	Zambezi Queen	£10,347

Flights: Please call for fares and availability.

All fares are per person, based on double occupancy in stateroom Cat. SB.

To upgrade to a higher category, add per person:

CAT.	DECK LEVEL	STATEROOM	ADD'L
SA	Lower/Middle	Balcony	£166
MS	Lower/Middle	Balcony	£566

Single Supplement: Categories SB-SA: add 40% per person; Category MS: add 100% per person.

Intra-Africa Air: £1,417 per person, including taxes and fuel surcharges, is included in the fare.

Deck Plans: ZAMBEZI QUEEN - See page 174.

Visas: For visa information, please refer to page 176



WONDEROUS DISCOVERIES AWAIT

INCLUDED FEATURES

JOHANNESBURG

- » Arrival airport transfer
- » 1 night at the Fairlawns Boutique Hotel, in a Grand Château suite including breakfast

ZAMBEZI QUEEN SAFARI CRUISE

- » 4-night accommodations in a balcony stateroom
- » Chobe National Park safari
- » Private boat safaris along the banks of the Chobe River
- » Visit to African village for a cultural interaction with the community
- » African-themed dinner
- » All meals included during the cruise with complimentary wine, beer and spirits

VICTORIA FALLS

- » 2-night stay at the Victoria Falls Hotel in upgraded Stable Wing rooms, including daily breakfast
- » Sunset cocktail reception aboard a historic steam train to Victoria Falls Bridge, followed by dinner
- » Guided tour of Victoria Falls National Park
- » Exclusive Zambezi River sunset cruise

JOHANNESBURG

- » 2 nights at the Fairlawns Boutique Hotel in a Grand Château suite, including breakfast daily
- » Presentation and discussion by local expert
- » Special multi-course dinner with wine
- » Johannesburg and Soweto tour with lunch

TANZANIA SAFARI LODGES

- » 1 night at Arusha Coffee Lodge
- » 2 nights at Tarangire Treetops
- » 2 nights at The Manor at Ngorongoro
- » 2 nights at Serengeti Migration Camp or Serengeti Pioneer Camp, both luxury tented camps
- » Day room at Arusha Coffee Lodge on your last day
- » Daily game drives with no more than 6 guests per vehicle
- » All meals, drinks and laundry service included

GOLDEN TRAILS OF EAST AFRICA

16 OR 18 NIGHTS · TRAVEL TO JOHANNESBURG OR CAPE TOWN AND RETURN FROM ARUSHA (KILIMANJARO), TANZANIA

1 NIGHT IN JOHANNESBURG, 4-NIGHT SAFARI CRUISE AND 2 NIGHTS IN VICTORIA FALLS, 2 NIGHTS IN JOHANNESBURG AND 7 NIGHTS AT LUXURY SAFARI LODGES IN TANZANIA



Ignite your sense of adventure with an overnight stay in Johannesburg, or if you prefer, you have the option to start with three nights in Cape Town. Afterwards, fly to Kasane, Botswana where you will board the Zambezi Queen for your four-night cruise along the Chobe River. From here, you'll enjoy two nights at Victoria Falls, one of the Seven Natural Wonders of the World, before flying to Johannesburg for another two night stay. Your journey continues with a flight to Kilimanjaro, Tanzania (via Nairobi). Tanzania is home to four of Africa's most renowned national parks. The National Parks include: Tarangire, the sixth largest park in Africa; Lake Manyara, known for its tree-climbing lions; Ngorongoro Conservation area, a vast protected area often called "Africa's Eden"; and Serengeti, Tanzania's oldest and most famous park, as well as a UNESCO World Heritage Site. While exploring this area, be treated to two nights at three of the four luxury Tanzanian lodges: Tarangire Treetops, The Manor at Ngorongoro, and the luxury-tented Serengeti Migration Camp or Serengeti Pioneer Camp.



DAILY PROGRAMME FEATURES

DAY	DESTINATION	ACTIVITIES
1	Johannesburg, South Africa	Hotel check-in
2	Johannesburg Zambezi Queen	Flight to Kasane, Botswana EMBARKATION Welcome Cocktail and Dinner
3	Zambezi Queen	Chobe River safaris by boat
4	Zambezi Queen	Full-day safari of Chobe National Park by open top 4x4 vehicle with picnic lunch
5	Zambezi Queen	Morning visit to local African village Afternoon safari by boat OR Birdwatching OR F-ishing African-themed dinner
6	Zambezi Queen	DISSEMBARKATION Transfer to Victoria Falls Sunset cocktail reception aboard a vintage steam train, followed by dinner
7	Victoria Falls	Guided tour of Victoria Falls Free afternoon Zambezi River sundowner cruise with tapas
8	Victoria Falls Johannesburg, South Africa	Flight to Johannesburg Special dinner and presentation
9	Johannesburg	Soweto tour with lunch
10	Johannesburg	Flight to Kilimanjaro, Tanzania Transfer to Arusha
11	Arusha, Tanzania	Drive to Tarangire National Park Tarangire safari Arrive at Tarangire Treetops
12	Tarangire	Morning bushwalk with lodge naturalist Afternoon safari and sunset drive in the bush
13	Tarangire Lake Manyara, Tanzania Ngorongoro, Tanzania	Visit Maasai village, drive to Lake Manyara Lake Manyara National Park safar Arrive at Ngorongoro
14	Ngorongoro	Full-day Ngorongoro Crater with picnic
15	Ngorongoro Serengeti, Tanzania	Flight to the Serengeti Afternoon safari and game drive
16	Serengeti	Morning and afternoon safari
17	Serengeti Arusha	Morning safari, flight back to Arusha Dayroom in Arusha Return flight home

 Embark 4-Night Safari Cruise

 Disembark 4-Night Safari Cruise

YOUR LODGE ACCOMMODATIONS

Golden Trails of East Africa safari includes stays in ultra-exclusive lodges, including Tarangire Treetops and The Manor at Ngorongoro

TARANGIRE TREETOPS



Each of Treetops' elevated rooms boasts a large bedroom with beautiful hand-crafted furnishings; this 'up-in-the-air' experience is further enhanced with views across the Tarangire plains from an expansive private balcony.

THE MANOR AT NGORONGORO



This gracious estate nestled near Tanzania's Ngorongoro Crater has 20 cottage suites, a dining conservatory, wine cellar, library and fireplace lounges.

DATES AND FARES (£)

HOTEL CHECK-IN DATE	EMBARK DATE	SHIP NAME	7-NIGHT CRUISE
Mar 11	Mar 12	Zambezi Queen	£12,080
Apr 01	Apr 02	Zambezi Queen	£12,147
Apr 22	Apr 23	Zambezi Queen	£12,213
May 06	May 07	Zambezi Queen	£12,280
May 20	May 21	Zambezi Queen	£12,347
Jun 03	Jun 04	Zambezi Queen	£12,347
Jun 17	Jun 18	Zambezi Queen	£12,413
Jul 08	Jul 09	Zambezi Queen	£12,413
Jul 22	Jul 23	Zambezi Queen	£12,413
May 08	Aug 06	Zambezi Queen	£12,413
Aug 19	Aug 20	Zambezi Queen	£12,413
Sep 02	Sep 03	Zambezi Queen	£12,413
Sep 16	Sep 17	Zambezi Queen	£12,413
Sep 30	Oct 01	Zambezi Queen	£12,413
Oct 14	Oct 15	Zambezi Queen	£12,347
Nov 04	Nov 05	Zambezi Queen	£12,147
Nov 18	Nov 19	Zambezi Queen	£12,080

Flights: Please call for fares and availability.

All fares are per person, based on double occupancy in stateroom Cat. SB.

To upgrade to a higher category, add per person:

CAT.	DECK LEVEL	STATEROOM	ADD'L
SA	Lower/Middle	Balcony	£166
MS	Lower/Middle	Balcony	£566

Single Supplement: Categories SB-SA: add 40% per person; Category MS: add 100% per person.

Intra-Africa Air: £1,750 per person, including taxes and fuel surcharges, is included in the fare.

Deck Plans: ZAMBEZI QUEEN - See page 174.

Visas: For visa information, please refer to page 176

3-NIGHT CAPE TOWN PRE-EXTENSION

Instead of spending your first night in Johannesburg, start your trip early and enjoy 3 nights in Cape Town before the cruise. This includes a full-day Cape of Good Hope tour and a full-day Cape Winelands or Robben Island tour as well as an extra flight from Cape Town to Johannesburg.

£1,450 per person



TWIN BALCONY STATEROOM



LOUNGE

AMALEA, AMAKRISTINA, AMAVIOLA & AMASTELLA



TWIN BALCONY SUITE



RECEPTION AREA



THE CHEF'S TABLE RESTAURANT

AMALEA, AMAKRISTINA, AMAVIOLA & AMASTELLA

The 156-passenger AmaLea, AmaKristina, AmaViola and AmaStella offer spacious staterooms with our exclusive twin balconies, a choice of dining venues, a heated pool with swim-up bar and more.

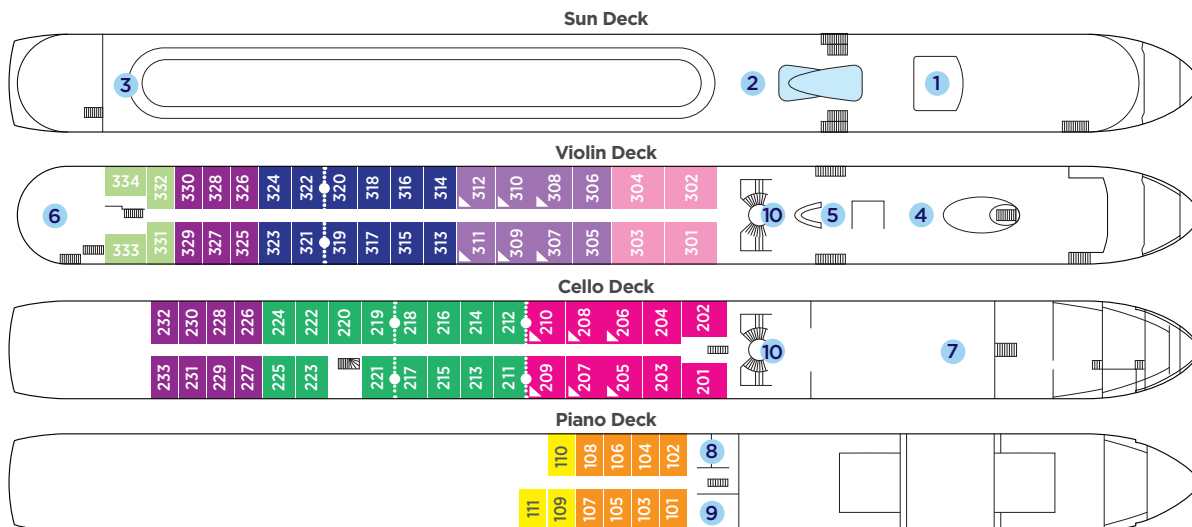

Note: Elevator on AmaLea & AmaKristina reaches Violin, Cello and Piano Deck. Elevator on AmaStella & AmaViola reaches Violin and Cello Deck only.

Suite	Violin Deck / French & Outside Balcony - 350 sq. ft.
Cat. AA	Violin Deck / French & Outside Balcony - 235 sq. ft.
Cat. AB	Cello Deck / French & Outside Balcony - 235 sq. ft.
Cat. BA	Violin Deck / French & Outside Balcony - 210 sq. ft.
Cat. BB	Cello Deck / French & Outside Balcony - 210 sq. ft.
Cat. CA	Violin & Cello Deck / French Balcony - 170 sq. ft.
Cat. CB	Violin Deck / French Balcony - 155 sq. ft.
Cat. D	Piano Deck / Fixed Windows - 160 sq. ft.
Cat. E	Piano Deck / Fixed Windows - 160 sq. ft.

Deck Plan

- Navigation Bridge
- Heated Pool
- Walking Track
- Main Lounge
- Reception
- The Chef's Table restaurant
- Main Restaurant
- Massage & Hair Salon
- Fitness Room
- Elevator

Technical Data

Built: AmaLea - 2018
AmaKristina - 2017
AmaStella - 2016
AmaViola - 2016
Length: 443 ft.
Width: 38 ft.
Crew: 51
Staterooms: 78
Passengers: 156
Registry: Switzerland

..... Staterooms separated by a dotted line become adjoining by request.

▲ Up to triple occupancy.

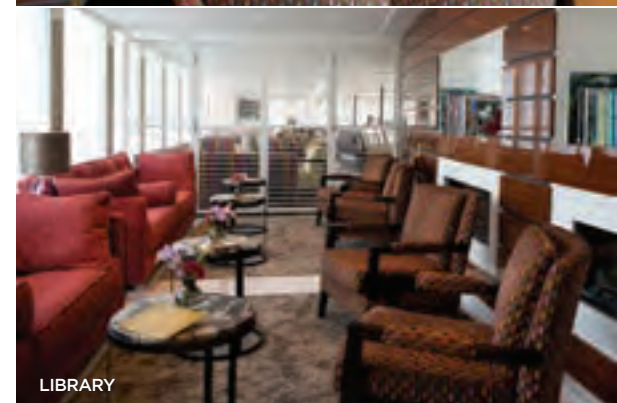
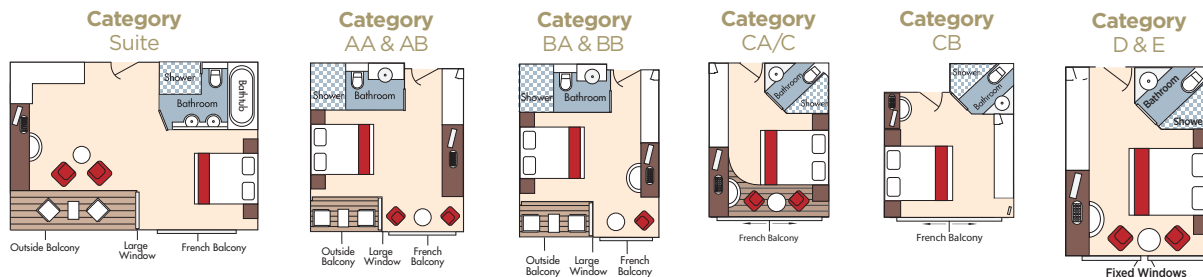



TWIN BALCONY STATEROOM



RECEPTION AREA

AMASERENA, AMAVENITA, AMASONATA, AMAREINA, AMAPRIMA & AMACERTO



MAIN RESTAURANT



LIBRARY



AMASERENA, AMAVENITA, AMASONATA, AMAREINA, AMAPRIMA & AMACERTO

These ships in Europe accommodate 162 passengers and feature exclusive signature twin balcony staterooms, heated swimming pool, salon services, fitness room, stunning glass elevator and much more.

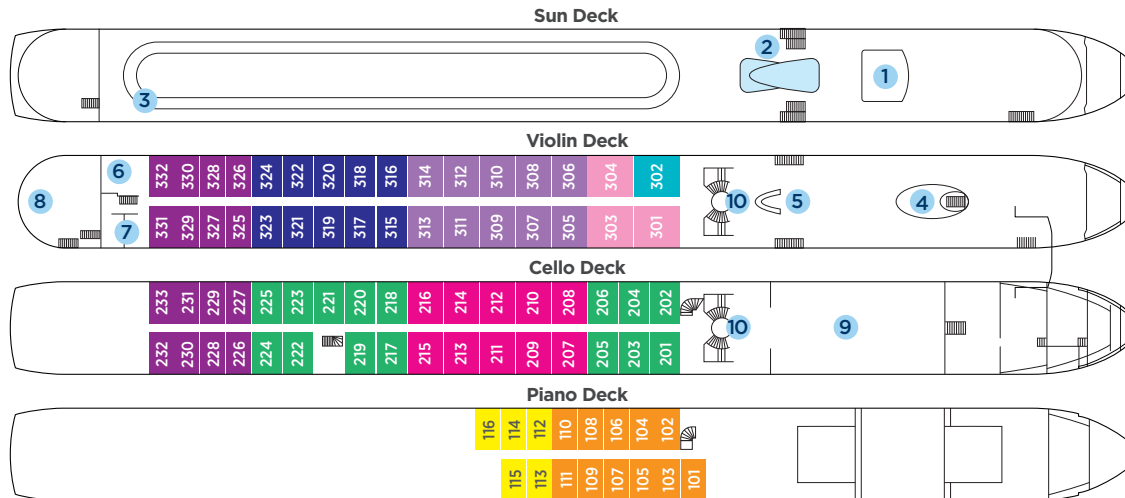

Note: Elevator reaches Main Restaurant, Lobby/Main Lounge and staterooms on Violin and Cello Deck (does not reach Piano Deck or Sun Deck).

Suite	Violin Deck / French & Outside Balcony - 300 sq. ft.
Cat. AA+	Violin Deck / French & Outside Balcony - 290 sq. ft.
Cat. AA	Violin Deck / French & Outside Balcony - 235 sq. ft.
Cat. AB	Cello Deck / French & Outside Balcony - 235 sq. ft.
Cat. BA	Violin Deck / French & Outside Balcony - 210 sq. ft.
Cat. BB	Cello Deck / French & Outside Balcony - 210 sq. ft.
Cat. C	Violin & Cello Deck / French Balcony - 170 sq. ft.
Cat. D	Piano Deck / Fixed Windows - 160 sq. ft.
Cat. E	Piano Deck / Fixed Windows - 160 sq. ft.

Deck Plan

- 1 Navigation Bridge
- 2 Heated Pool
- 3 Walking Track
- 4 Main Lounge
- 5 Reception
- 6 Fitness Room
- 7 Massage & Hair Salon
- 8 The Chef's Table restaurant
- 9 Main Restaurant
- 10 Elevator

Technical Data

Built: AmaSerena - 2015
 AmaVenita - 2015
 AmaSonata - 2014
 AmaReina - 2014
 AmaPrima - 2013
 AmaCerto - 2012

Length: 443 ft.
Width: 38 ft.
Crew: 51
Staterooms: 81
Passengers: 162
Registry: Switzerland

Note: Cat. AA+ stateroom has a modified Suite layout

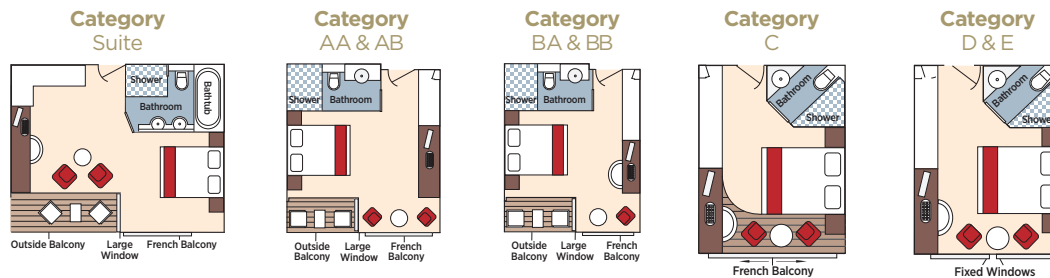

Note: Select staterooms on board the AmaSerena and AmaVenita can become adjoining by request; ask for details.





FRENCH BALCONY SUITE



STAIRWAY AND LIBRARY

AMALYRA, AMADOLCE, AMADANTE & AMACELLO



FRENCH BALCONY STATEROOM



SUN DECK



MAIN RESTAURANT

AMALYRA, AMADOLCE, AMADANTE & AMACELLO

These ships offer spacious 170 to 255 sq. ft. staterooms, most with French balconies. Other features include complimentary in-room Entertainment-On-Demand and internet, Wi-Fi, sun deck walking track and a fitness room.

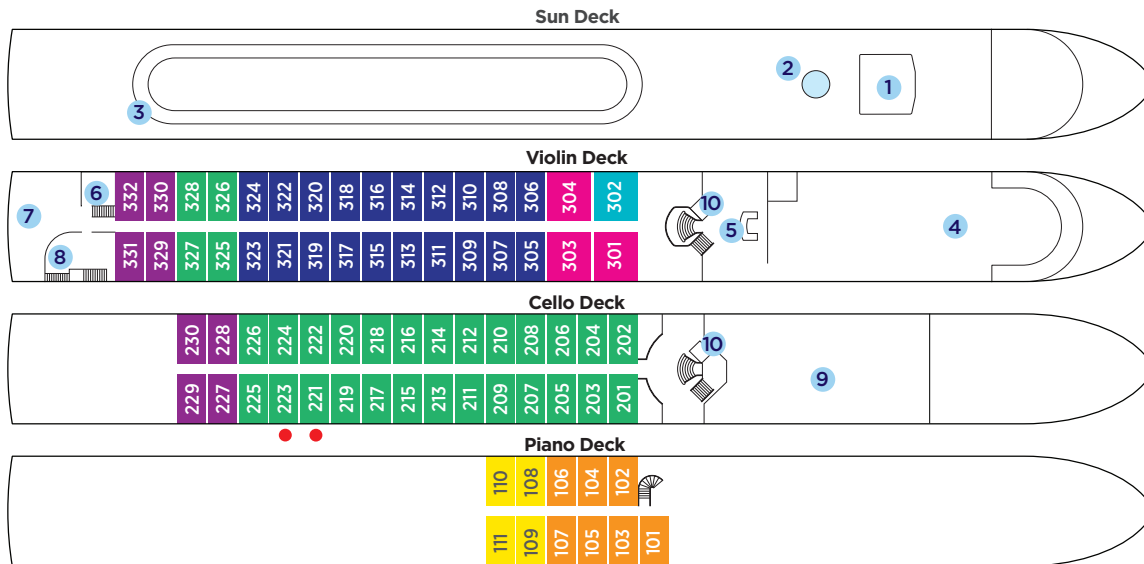

Note: Elevator reaches Violin and Cello Deck only.

- Suite Violin Deck / French Balcony - 255 sq. ft.
- Cat. A+ Violin Deck / French Balcony - 225 sq. ft.
- Cat. A Violin Deck / French Balcony - 170 sq. ft.
- Cat. B Violin & Cello Deck / French Balcony - 170 sq. ft.
- Cat. C Violin & Cello Deck / French Balcony - 170 sq. ft.
- Cat. D Piano Deck / Fixed Windows - 170 sq. ft.
- Cat. E Piano Deck / Fixed Windows - 170 sq. ft.
- Single Cello Deck / French Balcony - 140 sq. ft.

Note: Cat. A+ not offered on AmaCello.

Deck Plan

- 1 Navigation Bridge
- 2 Whirlpool
- 3 Walking Track
- 4 Main Lounge
- 5 Reception
- 6 Massage & Hair Salon
- 7 The Chef's Table restaurant
- 8 Fitness Room
- 9 Main Restaurant
- 10 Elevator

Technical Data

Built: AmaLyra - 2009
 AmaDolce - 2009
 AmaDante - 2008
 AmaCello - 2008

Length: 360 ft.
Width: 38 ft.
Crew: 45
Staterooms: 73
Passengers: 144
Registry: Switzerland

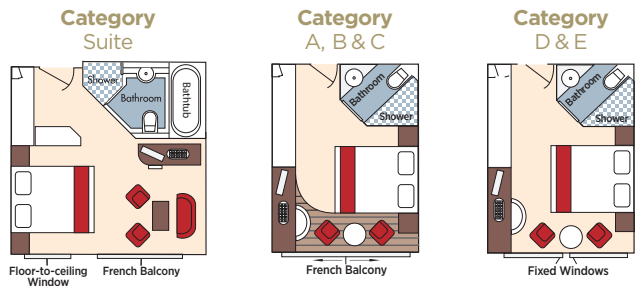

RECEPTION



MAIN LOUNGE AND BAR

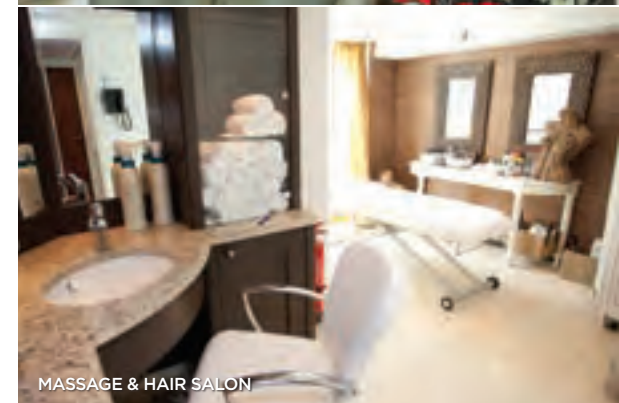

MASSAGE & HAIR SALON





BALCONY STATEROOM



AMAVIDA ON THE DOURO

AMAVIDA



SPACIOUS BALCONY STATEROOM



MAIN RESTAURANT



REFRESHING POOL

AMAVIDA

This 106-passenger ship brings AmaWaterways' distinctive standard of excellence to the Douro River, featuring balconies in the majority of its staterooms; fine dining in the main dining room plus *al fresco* dining; heated swimming pool and fitness room.

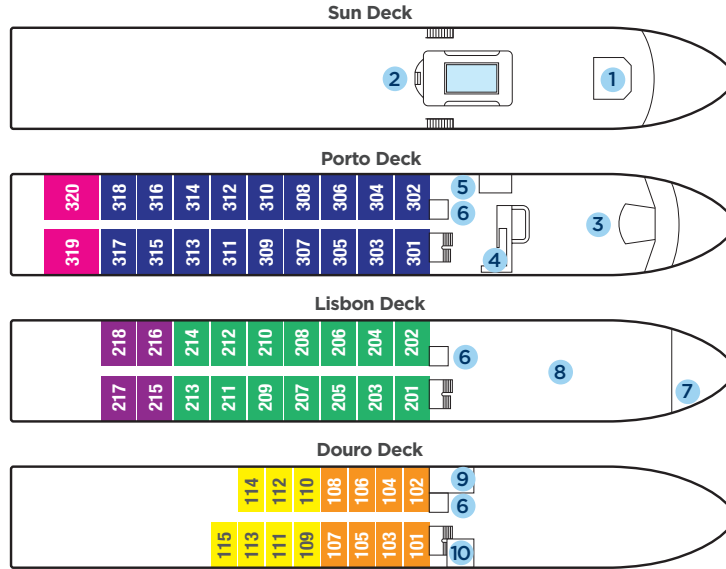

Note: Elevator reaches all three stateroom decks (does not reach Sun Deck).

Suite	Porto Deck / Balcony - 323 sq. ft.
Cat. A	Porto Deck / Balcony - 215 sq. ft.
Cat. B	Lisbon Deck / Balcony - 215 sq. ft.
Cat. C	Lisbon Deck / Balcony - 215 sq. ft.
Cat. D	Douro Deck / Panoramic Window - 161 sq. ft.
Cat. E	Douro Deck / Panoramic Window - 161 sq. ft.

Deck Plan

- 1 Navigation Bridge
- 2 Heated Pool
- 3 Main Lounge
- 4 Gift Shop
- 5 Reception
- 6 Elevator
- 7 *Al Fresco* Dining
- 8 Main Restaurant
- 9 Fitness Room
- 10 Spa

Technical Data

Built: 2013
Length: 260 ft.
Width: 37 ft.
Crew: 30
Staterooms: 53
Passengers: 106
Registry: Portugal

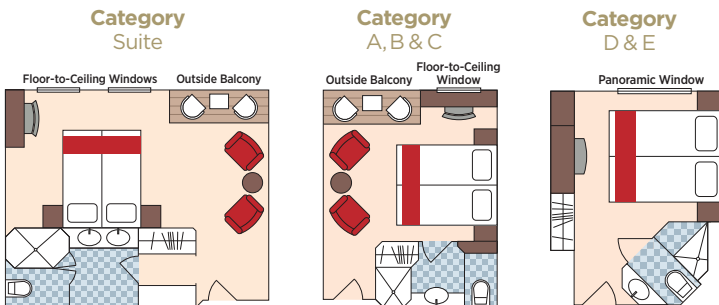

GIFT SHOP



LOUNGE





OUR AWARD-WINNING BEAUTIFUL SUITES ABOARD THE AMADARA



SUN DECK POOL

AMADARA



MEKONG RESTAURANT



TWIN-BALCONY STATEROOM



LUXURY SUITE

AMADARA

The 124-passenger AmaDara features spacious staterooms and suites, of which have private twin balconies. Public areas include two stylish restaurants, an inviting lounge, a fitness room, hair salon, spa and a refreshing sun deck pool.

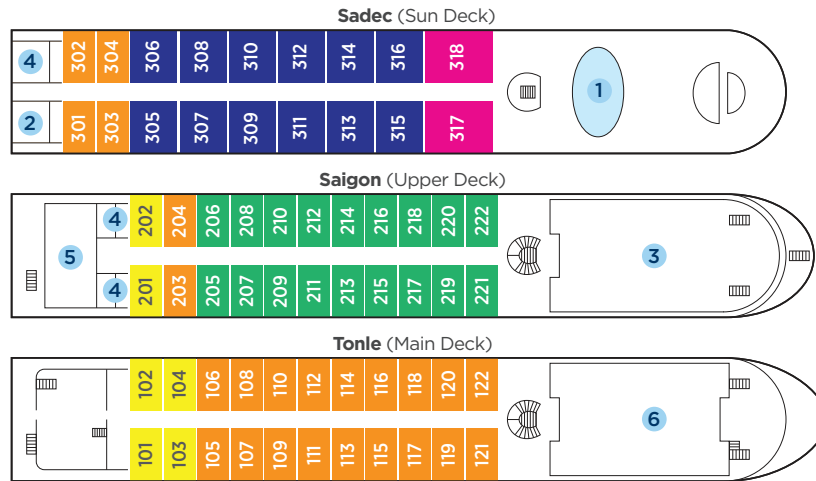

- Lux. Suite** Sadec Deck / French & Outside Balcony - 502 sq. ft.
- Suite** Sadec Deck / French & Outside Balcony - 366 sq. ft.
- Cat. A** Saigon Deck / French & Outside Balcony - 251 sq. ft.
- Cat. B** Sadec, Saigon & Tonle Deck / French & Outside Balcony - 251 sq. ft.
- Cat. C** Saigon & Tonle Deck / French & Outside Balcony - 251 sq. ft.

Deck Plan

- 1 Pool
- 2 Fitness Room
- 3 Saigon Lounge
- 4 Spa
- 5 The Chef's Table restaurant
- 6 Mekong Restaurant
- 7 Hair Salon (Lower deck, not shown)

Technical Data

- Built:** 2015
- Length:** 302 ft.
- Width:** 46 ft.
- Crew:** 52
- Staterooms:** 62
- Passengers:** 124
- Registry:** Vietnam

Category
Luxury Suite

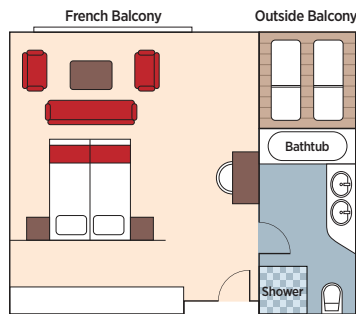

Category
Suite

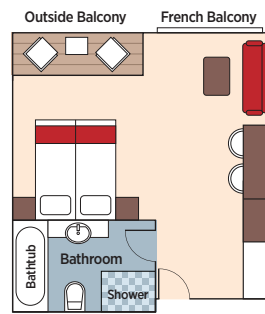

Category
A, B & C

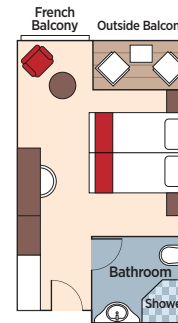

LUXURIOUS SAIGON LOUNGE



THE CHEF'S TABLE RESTAURANT





CONTEMPORARY-STYLE SUITE



ZAMBEZI QUEEN ON THE CHOBE

ZAMBEZI QUEEN



LOUNGE WITH VIEW



ELEGANT DINING ROOM



INTIMATE BAR

ZAMBEZI QUEEN

This intimate 28-passenger ship was designed exclusively for up-close wildlife viewing along Africa's Chobe River, with elegant décor and balconies in every stateroom.

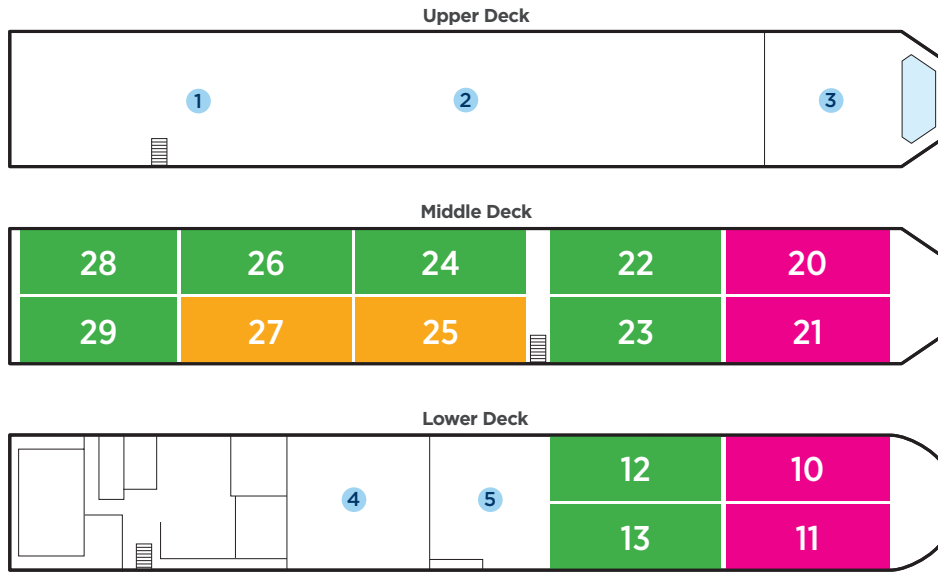

- MS** Lower & Middle Decks / Master Suite - Balcony - 300 sq. ft.
- Cat. SA** Lower & Middle Decks / Suite - Balcony - 235 sq. ft.
- Cat. SB** Middle Deck / Suite - Balcony - 215 sq. ft.

Deck Plan

- 1 Dining Room
- 2 Lounge
- 3 Pool Deck
- 4 Gift Shop & Cruise Manager's Office
- 5 Boarding Area

Technical Data

- Built:** 2009
- Refurbished:** 2015
- Length:** 150 feet
- Width:** 25.6 feet
- Crew:** 22
- Staterooms:** 14
- Passengers:** 28
- Registry:** Namibia



Eco-Tourism

- Responsibility towards the environment forms the foundation upon which the Zambezi Queen was built.
- A water jet propulsion system replaces the conventional propeller system, causing no damage to the river bed.
 - Only the latest fuel efficient and low emission generators are run during daylight hours, with the boat operating on battery power through the night.
 - Hot water is provided by a solar heating system.
 - Energy-saving lights throughout.
 - Water-saving taps and showers.
 - Onboard sewage processing plant.
 - Cleaning detergents and soaps are biodegradable.
 - Five-stage water purification plant, using river water in showers and tap.



TERMS & CONDITIONS

Parties: In these terms and conditions, “you” or “passenger” or “participant” refers to the person booking, purchasing or travelling on the cruise, and to individuals travelling as part of that person’s reservation. “We” or “us” refers to Amadeus Waterways Inc, a California corporation (AWI) and AmaWaterways, the trading name of AmaWaterways Ltd, a company registered in England with company number 10184331. AWI offers the travel and enters into these terms and conditions with you pursuant to arrangements made with AmaWaterways Ltd.

Deposit & Final Payment: To make a reservation, please contact AmaWaterways (AmaWaterways Ltd, Abbots Place Suite B, Walnut Tree Close, Guildford, GU1 4RW, Surrey, UK) on 0800 520 2250 (Trade Reservations) or 0800 320 2335 (Consumer Reservations) or your preferred ABTA Travel Agent. A deposit of £270 per person for Europe / Asia itineraries and £1,600 per person for Africa itineraries is required at time of booking. In addition to the cruise deposit, if air is purchased, AmaWaterways requires the full non-refundable air payment at time of booking. Hotel Extra Nights require a non-refundable deposit of £35 per stateroom at the time of confirmation of hotel availability. Final payment is due no later than 90 days prior to departure; non-payment may result in the reservation being cancelled.

Pricing: Unless indicated otherwise, all brochure prices are per person in British Pounds Sterling, based on double occupancy of a stateroom, or standard hotel room. Single rates are available for cruise at a supplement of 50%, except for suites which are 100%. Pricing is accurate at time of printing and expected to be in effect at the time of departure but may be subject to surcharge or reduction for the following items: transportation costs, including the cost of fuel, dues, taxes, or fees chargeable for services such as landing taxes or embarkation or disembarkation fees at ports and airports; government action such as increases in VAT or any other government imposed increases; or currency exchange rate fluctuations. Only amounts in excess of 2% of the holiday price excluding insurance premiums and any amendment charges will lead to a surcharge or reduction; any surcharge levied will include an amount to cover agent’s commission. If this means paying more than 10% above the holiday price quoted at time of booking, you will be entitled to cancel the holiday with a full refund of all money paid (not including any premium paid for holiday insurance and amendment charges). Such a cancellation must be made within 14 days of the issue date printed on the surcharge invoice. Failure to pay a surcharge within 14 days may be treated as cancellation of the booking by you, and a cancellation charge of the amount shown under “Cancellation Charges”

applicable on the date of AmaWaterways’ decision to cancel will be made. Cancellation Charges are dependent on the date of booking and are shown below. No surcharge or reduction will be made less than 30 days before the date of commencement of the holiday but bookings received within this period may be charged at the published price plus any surcharge arising up to the date of that booking. Airfares and air taxes quoted on your invoice or by a reservation agent are only guaranteed once full payment is received by AmaWaterways. A charge may apply to payments by credit card.

Not Included In The Price: Passports/visas, excess baggage fees; vaccinations; gratuities on cruise ships; laundry; beverages and food not on the regular table d’hôte menu; optional excursions; all other items of a personal nature; travel, health, personal items or accident protection plans. These items are paid locally. Governmental or local taxes/fees, airport taxes and fees and fuel surcharges not included in the price will be charged by invoice.

Cancellation Charges: In the unfortunate event that you cannot travel and you need to cancel, please notify AmaWaterways in writing. No cancellation can be taken without written notification. Cancellations are effective from the date of receipt of the written notification. If AmaWaterways has already issued final documentation that includes air tickets, the unused air tickets must be returned to AmaWaterways before they can be cancelled. Please note that any name change/ substitution of passenger is treated as a cancellation and any/all applicable cancellation charges will be applied. Cancellation charges are per person and shown below.

Passports and Visas: A valid passport is required for all travellers. Passports must be valid six months after the scheduled return date to the UK. UK and non-UK citizens must consult with the appropriate consulates if any visas are needed. Any visas, or travel documentation required to travel is the sole responsibility of the passenger to obtain. AmaWaterways is not responsible for delays or missed portions of your cruise/tour, relating to incorrect travel documents or visas. Visas are required for travel to Vietnam and Cambodia.

Vietnam – Guests travelling on Riches of the Mekong or Charms of the Mekong require a multiple entry visa to be obtained prior to departure from the UK.

Guests travelling for the 7 nights cruise-only or Amawaterways’ 10/12 nights package beginning or ending in Siem Reap or Ho Chi Minh City require a single entry visa to be obtained prior to departure from the UK.

Cambodia - A single entry visa to be obtained prior to departure from the UK.

E-Visas are not valid for travel to Vietnam and Cambodia.

Africa - Visas may be required for travel. Please check with the relevant Consulate/Embassy.

Please note, 6-8 consecutive blank passport pages are required for travel. Please check with the relevant Consulate/Embassy for specific visa requirements relating to the itinerary booked.

The above information is for UK Citizen Passport Holders is correct at time of printing and is provided as a courtesy. AmaWaterways cannot be held responsible for information supplied and all guests must check with the appropriate Embassy/Consulate for accurate information prior to travel.

Travel Documents: Upon full payment only, travel documents, including air tickets, are sent postal ground delivery 2-3 weeks prior to departure. If you would like your documents sent earlier, there is a £15 charge per reservation.

YOUR FLIGHTS

Airline Tickets (where applicable): AmaWaterways determines airlines and flight schedules based on the availability of its specific contracted carriers. Air tickets are economy class, unless requested otherwise, and are issued under the terms and conditions of the relevant airline(s). Business class air travel is available for purchase at the time of booking; please ask your reservation agent for details. Airlines require that your exact name, as it appears in your passport, be on your air ticket. AmaWaterways is not responsible for any issues resulting from an incorrect name on any air ticket issued. Every effort is made to obtain direct flights; however, your air schedule may require connections and overnight travel. AmaWaterways is not responsible for any costs resulting from lost air tickets, delays, disruptions or cancelled flights; lost baggage or missed connections. In the event of a lost air ticket, the passenger will need to file a Lost Ticket Application with the carrier.

Changes: All tickets issued by AmaWaterways have certain restrictions; they cannot be reissued or exchanged. Any changes or refunds must be processed through AmaWaterways. We reserve the right to charge an administration fee of £35, in addition to any appropriate airline fees for any changes made. Any cancellation is charged under the cancellation penalty of the airline. Airline fees vary depending on the carrier. Some air tickets will be non-refundable.

Special Requests: Requests for seat assignments, meal requirements, special services and frequent flyer miles are at the sole discretion of the airline; please contact the airline directly. Baggage: Please check with the appropriate airline regarding airline baggage allowances. In most cases, airlines allow 1 bag per person to be checked in. AmaWaterways assume no responsibility for loss, theft, damage or delay to passenger’s luggage. Baggage insurance is recommended.

Transfers: AmaWaterways can arrange transfers at time of booking.

Own Air: For passengers making their own air arrangements, please note that it is the passenger’s responsibility to obtain a valid ticket direct from an air carrier suitable for and in time for travel to the vessel and including local transfers which the passenger must arrange. AmaWaterways accepts no responsibility for any travel arrangement outside of the package provided to you.

GENERAL INFORMATION

Cruise Itineraries: Deviations to the planned cruise itineraries and hotels are possible, although every effort will be made to keep them as they are shown in the brochure and final documents. Should conditions render cruise routes unsafe for navigation, AmaWaterways reserves the right to provide alternative services, including but not limited to accommodation on the docked ship and/or substitute ground arrangements. AmaWaterways will make the effort to ensure that the places visited, excursions operated and the hotels or ships offered are as similar as possible to the ones originally planned. Any resulting changes will not result in a refund for the original services; all cruise routes are subject to change without notice.

Cancellations: AmaWaterways reserves the right to cancel, change, or postpone, any departure date and itinerary. In the event of a complete cancellation by AmaWaterways, we will issue a full refund of monies paid for the cruise/tour.

Child Policy: All guests under the age of 18 are to be in a stateroom with an adult, and must remain supervised at all times, and their safety is the responsibility of the accompanying adult(s). Children between the ages of 4-10 at the time of embarkation may share a stateroom with 2 adults provided the child is able to share the bed with the adults – no additional bed will be provided. Please be aware that balcony staterooms of any kind may be unsafe for small children if left unsupervised. Children 4-7 years old are not recommended on any programme and on our Africa programme, due to safety precautions, there is a minimum age limit of 12 years old, unless otherwise agreed upon by AmaWaterways. AmaWaterways does not provide child specific programmes or child-minding facilities.

Disabled Participants: Any disability requiring special attention must be reported to AmaWaterways at the time of booking. AmaWaterways will make reasonable efforts to accommodate the special needs of disabled cruise participants, but is not responsible for any denial of services by carriers, hotels, restaurants, or other independent suppliers. Tour buses are not equipped with wheelchair ramps and stateroom doors are not wide enough to allow access by standard wheelchairs. Wheelchairs and walkers cannot be carried on tour buses, due to space limitations. Wheelchair passengers should be aware of these limitations. For safety reasons, passengers in wheelchairs cannot be carried on ramps in ports where the ship is at anchor. We regret that we cannot provide individual assistance to a tour member for walking, getting on/off tour busses and other transportation vehicles, or other personal needs. A qualified travel companion must accompany travellers who need assistance.

Pregnancy: For the safety of parent and child, and depending on various circumstances, passengers who are at an advanced stage of pregnancy (after 5 months) may be subject to restrictions or exclusion concerning their ability to travel and/or board a ship. Please inform us immediately, so we can assess your personal circumstances and possible accommodation.

Medical: AmaWaterways does not employ doctors or nurses on their vessels. Should you require medical attention, local medical services can be contacted immediately. You are responsible for any and all charges resulting in either visiting the medical services, or their visiting you. AmaWaterways are not responsible for the type or quality of the medical services you may receive.

CANCELLATION CHARGES 2018

DAYS BEFORE DEPARTURE	CRUISE & LAND CANCELLATION CHARGE	AIRFARE CANCELLATION CHARGE
More than 121 days prior to departure	£135 (Europe & Asia)/£800 Africa	100% of the purchased airfare
120-90 days prior to departure	Loss of deposit	
89-60 days prior to departure	35% of the cruise and land price	
59-30 days prior to departure	50% of cruise and land price	
29-7 days prior to departure	80% of cruise and land price	
Less than 7 days prior to departure	100% of cruise and land price	

These cancellation charges apply to all bookings made for 2018 sailings on or after the 1st January 2017.

Inoculations and Medical Preparation: All passengers travelling on certain Africa itineraries will require Yellow Fever vaccination. AmaWaterways strongly recommends that all passengers take malaria pills for travel to Africa. Please contact your personal physician or local health department prior to travel for further detailed information and recommended precautionary measures.

Smoking: Smoking is only allowed on the Sun Deck of all ships.

Diets: Please advise AmaWaterways at time of booking of any special dietary requirements you may have and we will make every effort to accommodate your request. Please note that not all dietary requests are possible.

Disclaimer of Responsibility: AWI's arrangements are with AmaWaterways Ltd, and they arrange with others for services described in this confirmation and in our brochures. Transport on river cruise ships ("ships") or other forms of transport ("transport") is provided by third party owners, operators and charterers ("supplier(s)"). Suppliers are separate entities and are deemed not to be our principals, agents, employees or partners. We do not own or operate any ship or transport service. Accordingly, **WE DISCLAIM RESPONSIBILITY AND LIABILITY FOR, AND PARTICIPANT WAIVES, RELEASES AND ACKNOWLEDGES THAT THERE SHALL NOT BE ANY CLAIM OR RECOURSE AGAINST US FOR OR AS A CONSEQUENCE OF: BREACH OF DUTY, BREACH OF CONTRACT, NEGLIGENCE OR WILLFUL OR INTENTIONAL ACT, FAILURE TO ACT OR OMISSION BY ANY SUPPLIER.** Supplier and participant obligations and liabilities are subject in each case to terms and conditions of each supplier's contract of carriage or other supplier terms and conditions, and any and all applicable government laws and regulations and international conventions that apply, including, but not limited to choice of law, jurisdiction of disputes and limitations of liability and limitations on timing of claims. **PARTICIPANT AGREES THAT WE SHALL NOT BE LIABLE FOR ANY DAMAGE, LOSS (INCLUDING PERSONAL INJURY, DEATH, AND LOSS OF OR DAMAGE TO PROPERTY) OR EXPENSE OCCASIONED BY ANY ACT OR OMISSION OF ANY SUPPLIER PROVIDING SERVICES, OR ANY PROVIDER OF A TRAVEL PROTECTION PLAN, OR INSURER, OR OF ANY OTHER PERSON.** If the services of a supplier cannot be delivered or there are changes in any planned service for any reason beyond our control, we will make an effort to arrange similar services. Any resulting additional expenses will be participant's responsibility.

Limitation of Liability: REGARDLESS OF ANY OTHER PROVISIONS IN THIS CONFIRMATION AND IN OUR BROCHURES, OUR LIABILITY FOR BREACH, DAMAGE, LOSS, PERSONAL INJURY, DEATH, AND/OR LOSS OF OR DAMAGE TO PROPERTY, OR OTHER LOSS, INJURY OR DAMAGE, ALSO INCLUDING, BUT NOT LIMITED TO, ECONOMIC DAMAGES, EMOTIONAL DISTRESS, MENTAL SUFFERING AND/OR PHYSICAL OR PSYCHOLOGIC INJURY, WHETHER OCCURRING BEFORE THE START OF TRAVEL, AFTER TRAVEL HAS BEGUN, AFTER COMPLETION OF THE TRAVEL, OR MULTIPLE TIME PERIODS, AND REGARDLESS OF WHETHER DUE TO ACCIDENTAL OR WILLFUL OR INTENTIONAL ACT OR OMISSION OF ANY PERSON OR ENTITY, OR OTHER CAUSE SHALL NOT EXCEED THE AMOUNT PAID TO US FOR THE TRAVEL NOTES

Responsibility: AmaWaterways is responsible to you in making arrangements for the services on your confirmation invoice. If the services of the supplier cannot be delivered,

subject to 'Cruise Itineraries' clause above, or for reasons beyond the control of AmaWaterways, we will arrange for the provision of comparable services, where and when possible. Any resulting additional expense will be payable by the cruise participants and any resulting saving received will be refunded to cruise participants.

Agreement: Payment of deposit and/or issue of your confirmation invoice shall be deemed your consent to the terms and conditions herein. The statements herein and the contract between cruise participants and AmaWaterways is made on the terms of these booking conditions, which are governed by English Law, and the jurisdiction of the English Courts. Terms and Conditions listed are those in effect at time of printing and will remain until replaced. Any new or reissue of Terms and Conditions will replace all previous versions. No person, other than an authorised representative of AmaWaterways, by a document in writing, is authorised to vary, add or waive any term or condition in this brochure, including any term or condition set forth in the preceding provisions.

Complaints: If you have a problem during your holiday, please inform the relevant supplier (e.g. your hotelier) and AmaWaterways representative immediately who will endeavour to put things right. If your complaint is not resolved locally, please follow this up within 28 days of your return home by writing to the following address: AmaWaterways Ltd, Abbots Place Suite B, Walnut Tree Close, Guildford, GU1 4RW, Surrey, UK giving your booking reference and all other relevant information. Please keep your letter concise and to the point. This will assist us to quickly identify your concerns and speed up our response to you. It is strongly recommended that you communicate any complaint to the supplier of the services in question without delay.

YOUR FINANCIAL PROTECTION

ABTA: AmaWaterways Ltd is a member of ABTA with membership number Y6393. ABTA & ABTA Members help holidaymakers get the most from their travel and assist them when things do not go according to plan. We are obliged to maintain a high standard of service to you by ABTA's Code of Conduct. We can also offer you ABTA's scheme for the resolution of disputes which is approved by the Chartered Trading Standards Institute. If we can't resolve your complaint, go to www.abta.com to review ABTA's simple procedure. Further information on the CODE and ABTA's assistance in resolving disputes can be found on www.abta.com. You can also access the European Commission Online Dispute (ODR) Resolution platform at <http://ec.europa.eu/consumers/odr/>. This ODR Platform is a means of registering your complaint with us; it will not determine how your conflict should be resolved. For further information about ABTA, the Code of Conduct and the arbitration scheme available to you if you have a complaint, contact ABTA, 30 Park Street, London SE1 9EQ. Tel 0203 117 0500 or www.abta.com.

ATOL: We hold an Air Travel Organisers License (ATOL) issued by the CAA (ATOL Number 11232). When you buy an ATOL protected flight or flight inclusive holiday from us you will receive an ATOL Certificate. This lists what is financially protected, where you can get information on what this means for you and who to contact if things go wrong. We, or the suppliers identified on your ATOL Certificate, will provide you with the services listed on the ATOL Certificate (or a suitable alternative). In some cases, where neither we nor the supplier are able to do so for reasons of insolvency, an alternative ATOL holder may provide you with the services you have

bought or a suitable alternative (at no extra cost to you). You agree to accept that in those circumstances the alternative ATOL holder will perform those obligations and you agree to pay any money outstanding to be paid by you under your contract to that alternative ATOL holder. However, you also agree that in some cases it will not be possible to appoint an alternative ATOL holder, in which case you will be entitled to make a claim under the ATOL scheme (or your credit card issuer where applicable). If we, or the suppliers identified on your ATOL certificate, are unable to provide the services listed (or a suitable alternative, through an alternative ATOL holder or otherwise) for reasons of insolvency, the Trustees of the Air Travel Trust may make a payment to (or confer a benefit on) you under the ATOL scheme. You agree that in return for such a payment or benefit you assign absolutely to those Trustees any claims which you have or may have arising out

of or relating to the non-provision of the services, including any claim against us, the travel agent (or your credit card issuer where applicable). You also agree that any such claims may be re-assigned to another body, if that other body has paid sums you have claimed under the ATOL scheme.

Passenger Contract: All transport on board ship is provided subject to the terms and conditions of the Passenger Contract that you will receive with your final documentation. The Passenger Contract is governed by the Law of Switzerland and is subject to the limits of liability and claims laid out under the Athens Convention Relating to the Carriage of Passengers and Their Luggage by Sea, 1974 and the International Convention on Limitation of Liability for Maritime Claims. Any disputes will be litigated exclusively in the courts.

CONCIERGE GOLF TERMS & CONDITIONS

Deposit & Final Payment: A Deposit of £270 per person for the Golf Programme is required at the time of booking. Final payment is due no later than 90 days prior to departure; non-payment may result in the reservation being cancelled

Single Supplement: If there is only one golfer on your cruise departure, a single supplement of 50% will be applied to your Golf Programme fare. The Supplement will cover the costs of providing you with a playing partner (LGT Golf Staff) at each of the venues. Should this situation arise, you will be informed approximately 120 days prior to departure at which time you may choose to cancel your Golf Programme at no charge. Cruise Cancellation charges will continue to apply as below.

Itineraries: Golf courses are subject to change due to circumstances beyond our control. Cruise Itineraries are subject to change due to government regulations, water conditions and other factors. We reserve the right to adjust the itinerary as deemed necessary.

Medical: Guests confirm that they do not have any physical or other condition or disability that would create a hazard for themselves or any other participant of the golf excursion. The right is reserved to decline to accept or retain anyone as an excursion participant at his/her expense. In the event of an emergency guests authorise medical personnel to

share critical health information with LGT Golf staff to help expedite appropriate medical response.

Insurance: It is recommended that each participant holds travel insurance to cover the travelling period.

LGT Tour Order of Merit: The LGT Tour Order of Merit is not associated with any professional sporting body such as the PGA, European Tour etc. The Prizes awarded at the end of the season cannot be exchanged for cash. The prize of a free golf package will only be accepted with a valid cruise cabin booking the following year of the award on any of the LGT Golf operated golf tours. The same conditions apply to the discount vouchers. The other prizes such as golf equipment are also not able to be exchanged for cash or discount vouchers. The Tour Order of Merit will be played in Stroke Play format less handicap. The honour system applies. If sufficient evidence of abusing the system is presented, LGT Golf retains the right to automatically disqualify said participant. Prizes for the LGT Tour Order of Merit are subject to a minimum number of golfers per prize category over the course of the year (15). Should the minimum number of golfers not be met in the men's category, the Men's and Men's Senior categories will be combined to one category. The same will apply with Women's and Women's Senior categories.

GOLF CANCELLATION CHARGES 2018

DAYS BEFORE DEPARTURE	GOLF PROGRAMME PRICE
More than 121 days prior to departure	25% of Golf Programme Fees
120-90 days prior to departure	25% of Golf Programme Fees
89-60 days prior to departure	50% of Golf Programme Fees
59-30 days prior to departure	75% of Golf Programme Fees
29-7 days prior to departure	85% of Golf Programme Fees
Less than 7 days prior to departure	100% of Golf Programme Fees

AMAWATERWAYS™

AMAWATERWAYS LTD
ABBOTS PLACE SUITE B
WALNUT TREE CLOSE
GUILDFORD
SURREY
GU1 4RW
UK

Tel. +377 97 98 41 31

WWW.SEAGNATURE.COM



FIRST EDITION
051720K